



EM-2260 Development Kit Quick Installation Guide

Second Edition, April, 2009

1. Overview

The MOXA EM-2260 embedded module uses the Cirrus Logic ARM9 200 MHz CPU, and comes with 128 MB RAM, 32 MB flash disk, dual 10/100 Mbps Ethernet, 8+8 digital I/O, four high speed serial ports, two USB 2.0 hosts and an EIDE interface for external storage connections such as a CompactFlash card. In addition, the built-in VGA interface makes the EM-2260 suitable for SCADA systems in industrial applications, such as manufacturing automation, production line process monitoring, and mining automation. Programmers will find the pre-installed, ready-to-run embedded operating system and full-function development kit a great benefit for developing software and building reliable communication applications.

2. Package Checklist

The EM-2260 Development Kit contains the following items:

- EM-2260 embedded module
- EM-2260-DK, the carrier board of EM-2260
- Peripheral extension board
- Quick Installation Guide
- Document and Software CD
- Ethernet Cable: RJ45 to RJ45 cross-over cable, 100 cm
- Universal Power Adaptor
- Product Warranty Statement

3. Hardware Installation

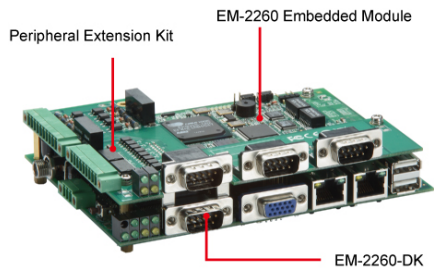

P/N: 1802022600011

EM-2260 Embedded Module

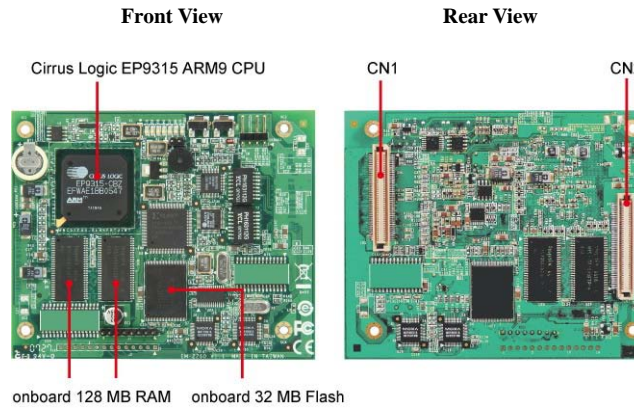

EM-2260-DK Carrier Board and Peripheral Extension Board

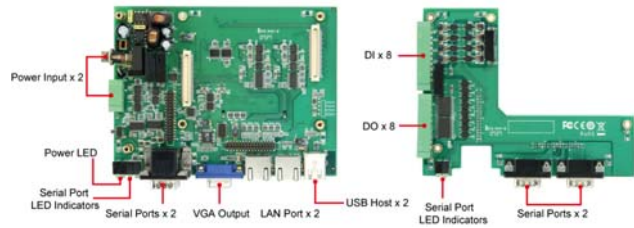

Connecting the Power

The EM-2260 Development Kit has two kinds of power input: a power jack and a 3-pin terminal block. Both options accommodate a 12 to 48V DC power input, and can be connected at the same time to provide a redundant power solution. If the power is properly supplied, the Power LED will light up first, and then it will take **30 to 60 seconds** for the operating system to boot up. Once the system is ready, the Ready LED will light up.

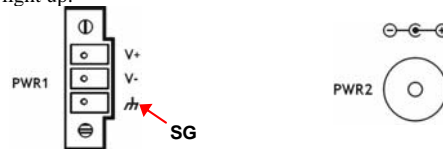

The Shielded Ground (SG, sometimes called Protected Ground) helps limit the effects of noise due to electromagnetic interference (EMI). Run the ground connection from the ground screw to the grounding surface prior to connecting devices.

Connecting to a Display

The EM-2260 Development Kit comes with a D-Sub 15-pin female connector to connect a VGA monitor. Be sure to disconnect the power before connecting or disconnecting the monitor cable.

LED Indicators

The EM-2260 Development Kit has 15 LED indicators on the front panel. Refer to the table below for information a description of each LED.



LED	Color	Description
Power	Green	Power is ON.
	Off	No power is being received, or power error exists.
Ready	Green	OS is ready and functioning normally (after booting up).
	Off	OS is not ready.
Storage	Green	Data is being written to or read from the storage unit.
	Off	Storage unit is idle.
LAN1, LAN2	Orange	10 Mbps Ethernet connection
	Green	100 Mbps Ethernet connection
P1-P4 (TX)	Green	Serial port is transmitting TX data to the serial device.
	Off	Serial port is not transmitting TX data to the serial device.
P1-P4 (RX)	Orange	Serial port is receiving RX data from the serial device.
	Off	Serial port is not receiving RX data to the serial device.

Connecting to a Keyboard and Mouse

Use the 2 USB hosts located on the front panel of the unit to connect a keyboard and mouse to the EM-2260 Development Kit.



Reset to Factory Default

Press the Reset switch near the power terminal block for at least 5 seconds to load the factory default configuration. After the factory default configuration has been loaded, the system will reboot automatically. We recommend that you only use this function if the software is not working properly and you want to load factory default settings.



Serial Ports

The EM-2260 Development Kit offers 4 software-selectable serial ports. Each port can be configured by software for RS-232, RS-422, or RS-485. The pin assignments for the ports are shown in the following table:

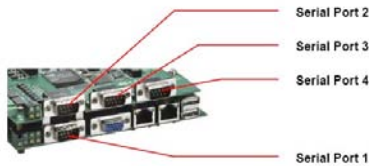

Pin	RS-232	RS-422	RS-485 (4-wire)	RS-485 (2-wire)
1	DCD	TxDA(-)	TxDA(-)	---
2	RxD	TxDB(+)	TxDB(+)	---
3	TxD	RxDB(+)	RxDB(+)	DataB(+)
4	DTR	RxDA(-)	RxDA(-)	DataA(-)
5	GND	GND	GND	GND
6	DSR	---	---	---
7	RTS	---	---	---
8	CTS	---	---	---

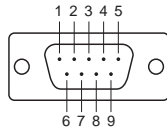

Connecting to the DI/DO

The EM-2260 has 8 digital inputs and 8 digital outputs, both of which support 3 KV optical isolation protection. The pinouts for the I/O are shown below.

Digital Input Channel (10-pin Terminal Block)

Digital Output Channel (9-pin Terminal Block)

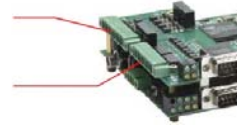

Digital Input Wiring

Dry Contact

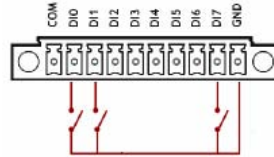

Wet Contact

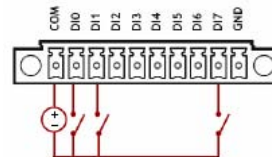

ATTENTION

If you are using wet contacts, you must supply power to "COM".

Digital Output Wiring

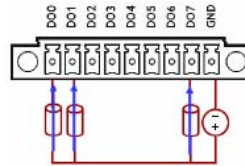

LAN Ports

The EM-2260 embedded module that comes with the EM-2260 Development Kit has 2 LAN ports that support 10/100 Mbps. The default IP addresses and netmasks of the network interfaces are shown below:

8-pin RJ 45

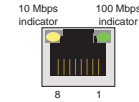

Pinouts

Pin	Signal
1	ETx+
2	ETx-
3	ERx+
4	---
5	---
6	ERx-
7	---
8	---

	Default IP Address	Netmask
LAN 1	192.168.3.127	255.255.255.0
LAN 2	192.168.4.127	255.255.255.0

Console Port

The 4-pin pin-header RS-232 console port is designed for serial terminals, which is useful for debugging when the system cannot boot up. A special serial console cable (must be purchased separately) is available for connecting to the console port. Please refer to the User's Manual for details.

Serial Console Port & Pinouts



Pin	Signal
1	TxD
2	RxD
3	NC
4	GND

Serial Console Cable



Click here for online support:
www.moxa.com/support

The Americas: +1-714-528-6777 (toll-free: 1-888-669-2872)
Europe: +49-89-3 70 03 99-0
Asia-Pacific: +886-2-8919-1230
China: +86-21-5258-9955 (toll-free: 800-820-5036)

© 2009 Moxa Inc. All rights reserved.
Reproduction without permission is prohibited.