

ioLogik E1200H Series User's Manual

Edition 2.1, January 2017

www.moxa.com/product

MOXA®

© 2017 Moxa Inc. All rights reserved.

ioLogik E1200H Series User's Manual

The software described in this manual is furnished under a license agreement and may be used only in accordance with the terms of that agreement.

Copyright Notice

© 2017 Moxa Inc. All rights reserved.

Trademarks

The MOXA logo is a registered trademark of Moxa Inc.
All other trademarks or registered marks in this manual belong to their respective manufacturers.

Disclaimer

Information in this document is subject to change without notice and does not represent a commitment on the part of Moxa.

Moxa provides this document as is, without warranty of any kind, either expressed or implied, including, but not limited to, its particular purpose. Moxa reserves the right to make improvements and/or changes to this manual, or to the products and/or the programs described in this manual, at any time.

Information provided in this manual is intended to be accurate and reliable. However, Moxa assumes no responsibility for its use, or for any infringements on the rights of third parties that may result from its use.

This product might include unintentional technical or typographical errors. Changes are periodically made to the information herein to correct such errors, and these changes are incorporated into new editions of the publication.

Technical Support Contact Information

www.moxa.com/support

Moxa Americas

Toll-free: 1-888-669-2872
Tel: +1-714-528-6777
Fax: +1-714-528-6778

Moxa Europe

Tel: +49-89-3 70 03 99-0
Fax: +49-89-3 70 03 99-99

Moxa India

Tel: +91-80-4172-9088
Fax: +91-80-4132-1045

Moxa China (Shanghai office)

Toll-free: 800-820-5036
Tel: +86-21-5258-9955
Fax: +86-21-5258-5505

Moxa Asia-Pacific

Tel: +886-2-8919-1230
Fax: +886-2-8919-1231

Table of Contents

1. Introduction	1-1
Product Model Information	1-2
Product Features	1-2
Inside the Box	1-2
Product Specifications	1-3
ioLogik E1200H Common Specifications	1-3
ioLogik E1261H	1-4
ioLogik E1263H	1-5
Physical Dimensions	1-6
Hardware Reference	1-8
Panel Guide	1-8
LED Indicators	1-8
2. Initial Setup	2-1
Hardware Installation	2-2
Connecting the Power	2-2
Grounding the ioLogik E1200H	2-2
Connecting to the Network	2-2
I/O Wiring Diagrams	2-3
Software Installation	2-4
Load Factory Defaults	2-4
3. Using the Web Console	3-1
Introduction to the Web Console	3-2
Overview	3-3
Network Settings	3-4
General Settings	3-4
Ethernet Configuration	3-4
User-defined Modbus Addressing	3-5
Default Address	3-5
AOPC Server Settings	3-6
Tag Generation	3-6
I/O Settings	3-8
DI Channels	3-8
DO Channels	3-10
AI Channels	3-11
AI Input Range	3-12
RTD Channels	3-14
System Management	3-16
IP Accessibility	3-16
Network Connection	3-17
Firmware Update	3-17
Import System Configuration Settings	3-17
Export System Configuration Settings	3-18
RS-485 Configuration	3-18
Changing the Password	3-18
Load Factory Defaults	3-19
Save/Restart	3-19
4. Using ioSearch	4-1
Introduction to ioSearch	4-2
ioSearch Main Screen	4-2
Main Screen Overview	4-2
Main Items	4-3
System	4-3
Sort	4-4
Quick Links	4-4
Main Function	4-5
Locate	4-5
Firmware Upgrade	4-5
Unlock	4-6
Import	4-6
Export	4-6
Change IP Address	4-7
Batch TCP/IP Configuration on Multiple Devices	4-7
Restart System	4-8
Reset to Default	4-8
Mass Deployment (Import)	4-8
Mass Deployment (export)	4-9
A. Modbus/TCP Default Address Mappings	A-1

E1261H Modbus Mapping.....	A-2
E1263H Modbus Mapping.....	A-8
B. Network Port Numbers.....	B-1
C. Factory Defaults.....	C-1
D. Pinouts.....	D-1
E. FCC Interference Statement.....	E-1
F. European Community (CE)	F-1

Introduction

The ioLogik E1200H series is a stand-alone remote Ethernet I/O server that can connect sensors and on/off switches for automation applications over Ethernet and IP-based networks.

The following topics are covered in this chapter:

- ❑ **Product Model Information**
- ❑ **Product Features**
- ❑ **Inside the Box**
- ❑ **Product Specifications**
 - ioLogik E1200H Common Specifications
 - ioLogik E1261H
 - ioLogik E1263H
- ❑ **Physical Dimensions**
- ❑ **Hardware Reference**
 - Panel Guide
 - LED Indicators

Product Model Information

Model	Description
ioLogik E1261H	Remote Ethernet I/O with 2-port Ethernet switch and 12DIOs, 5AIs and 3RTDs, -40 to 75°C operating temperature
ioLogik E1263H	Remote Ethernet I/O with 2-port Ethernet switch and 24DIOs, 10AIs and 3RTDs -40 to 75°C operating temperature

Product Features

- IEC 60945 certification pending harsh maritime environment
- Wide temperature tolerance: operates between -40 and 75°C (-40 to 167°F)
- Seamless SCADA connectivity with Active OPC™ technology.
- User-defined Modbus/TCP addressing
- MXIO programming library for Windows and WinCE VB/VC.NET and Linux C APIs
- Web configuration with Import/Export function

Inside the Box

The ioLogik E1200H is shipped with the following items:

- ioLogik E1200H Remote Ethernet I/O Server.

NOTE: Notify your sales representative if any of the above items are missing or damaged.

Product Specifications

ioLogik E1200H Common Specifications

LAN

Ethernet: 2 x 10/100 Mbps switch ports, RJ45

Protection: 1.5KV magnetic isolation

Protocols: Modbus/TCP, TCP/IP, UDP, DHCP, Bootp, HTTP

Serial Communication

Interface: 1 x RS-232/422/485, software selectable (9-pin D-Sub male)

Serial Line Protection: 4/8 KV ESD for all signals

Serial Communication Parameters

Parity: None

Data Bits: 8

Stop Bits: 1

Flow Control: None

Baudrate: 2400, 4800, 9600, 19200, 38400, 57600, 115200 bps

Protocol: Modbus/RTU

Power Requirements

Power Input: 24 VDC nominal, 12 to 48 VDC

Physical Characteristics

Wiring: I/O cable max. 14 AWG

Mounting: DIN-Rail (standard), wall (with optional kit)

Environmental Limits

Operating Temperature: -40 to 75°C (-40 to 176°F)

Storage Temperature: -40 to 85°C (-40 to 185°F)

Ambient Relative Humidity: 5 to 95% (non-condensing)

Standards and Certifications

Safety: UL 508 (Pending)

EMI: EN 61000-3-2; EN 61000-3-3; EN 61000-6-4; FCC Part 15, Subpart B, Class A

EMS: EN 55024, EN 61000-4-2, EN 61000-4-3, EN 61000-4-4, EN 61000-4-5, EN 61000-4-6, EN 61000-4-8, EN 61000-4-11, EN 61000-6-2

Shock: IEC 60068-2-27

Freefall: IEC 60068-2-32

Vibration: IEC 60068-2-6

Marine Communications: IEC 60945, 4th Edition (Pending)

Green Product: RoHS, CRoHS, WEEE

Note: Check Moxa's website for the most up-to-date certification status.

Warranty

Warranty Period: 5 years

Details: See www.moxa.com/warranty

ioLogik E1261H

Inputs and Outputs

Analog Inputs: 5 channels

RTD Inputs: 3 channels

Configurable DIOs: 12 channels

Isolation: 3K VDC or 2K Vrms

Analog Input

Type: Differential input

Resolution: 16 bits

I/O Mode: Voltage/Current

Input Range: 0 to 10V, 0 to 20 mA, 4 to 20 mA

Accuracy:

- $\pm 0.5\%$ FSR @ 25°C
- $\pm 1.0\%$ FSR @ -40 and 75°

Sampling Rate (all channels): 12 samples/sec

Input Impedance: 10M ohms (minimum)

Built-in Resistor for Current Input: 120 ohms

Digital Input

Sensor Type: Wet Contact (NPN or PNP), Dry Contact

I/O Mode: DI or Event Counter (channel 0~3)

Dry Contact:

- On: short to GND
- Off: open

Wet Contact (DI to GND):

- On: 0 to 3 VDC
- Off: 10 to 30 VDC

Common Type: 12 points per COM

Counter Frequency: 250 Hz

Digital Filtering Time Interval: Software selectable

RTD Inputs

Input Type:

- PT100 (3-wire): -200 to 850°C

Sampling Rate: 12 samples/sec (all channels)

Resolution: 0.5°C

Accuracy:

- $\pm 0.5\%$ FSR @ 25°C
- $\pm 1.0\%$ FSR @ -40 and 75°C

Input Impedance: 625K ohms

Digital Output

Type: Sink

I/O Mode: DO or Pulse Output (channel 0~3)

Pulse Output Frequency: 500 Hz

Over-voltage Protection: 45 VDC

Over-current Protection: 2.6 A (4 channels @ 650 mA)

Over-temperature Shutdown: 175°C (typical), 150°C (min.)

Output Current Rating: 200 mA per channel

Power Requirements

Power Input: 24 VDC nominal, 12 to 48 VDC

Power Consumption: 284 mA @ 24 VDC

Physical Characteristics

Dimensions: 140 x 113 x 36.3 mm (5.51 x 4.45 x 1.43 in)

Weight: 825g

ioLogik E1263H

Inputs and Outputs

Analog Inputs: 10 channels

RTD Inputs: 3 channels

Configurable DIOs: 24 channels

Isolation: 3K VDC or 2K Vrms

Analog Input

Type: Differential input

Resolution: 16 bits

I/O Mode: Voltage/Current

Input Range: 0 to 10V, 0 to 20 mA, 4 to 20 mA

Accuracy:

- $\pm 0.5\%$ FSR @ 25°C
- $\pm 1.0\%$ FSR @ -40 and 75°

Sampling Rate (all channels): 12 samples/sec

Input Impedance: 10M ohms (minimum)

Built-in Resistor for Current Input: 120 ohms

Digital Input

Sensor Type: Wet Contact (NPN or PNP), Dry Contact

I/O Mode: DI or Event Counter (channel 0~7)

Dry Contact:

- On: short to GND
- Off: open

Wet Contact (DI to GND):

- On: 0 to 3 VDC
- Off: 10 to 30 VDC

Common Type: 12 points per COM

Counter Frequency: 250 Hz

Digital Filtering Time Interval: Software configurable

RTD Inputs

Input Type:

- PT100 (3-wire): -200 to 850°C

Sampling Rate: 12 samples/sec (all channels)

Resolution: 0.5°C

Accuracy:

- $\pm 0.5\%$ FSR @ 25°C
- $\pm 1.0\%$ FSR @ -40 and 75°C

Input Impedance: 625K ohms

Digital Output

Type: Sink

I/O Mode: DO or Pulse Output (CH0~7)

Pulse Output Frequency: 500 Hz

Over-voltage Protection: 45 VDC

Over-current Protection: 2.6 A (4 channels @ 650 mA)

Over-temperature Shutdown: 175°C (typical), 150°C (min.)

Output Current Rating: 200 mA per channel

Power Requirements

Power Input: 24 VDC nominal, 12 to 48 VDC

Power Consumption: 425 mA @ 24 VDC

Physical Characteristics

Dimensions: 204 x 113 x 36.3 mm (8.03 x 4.45 x 1.43 in)

Weight: 945g

Physical Dimensions

ioLogik E1261H

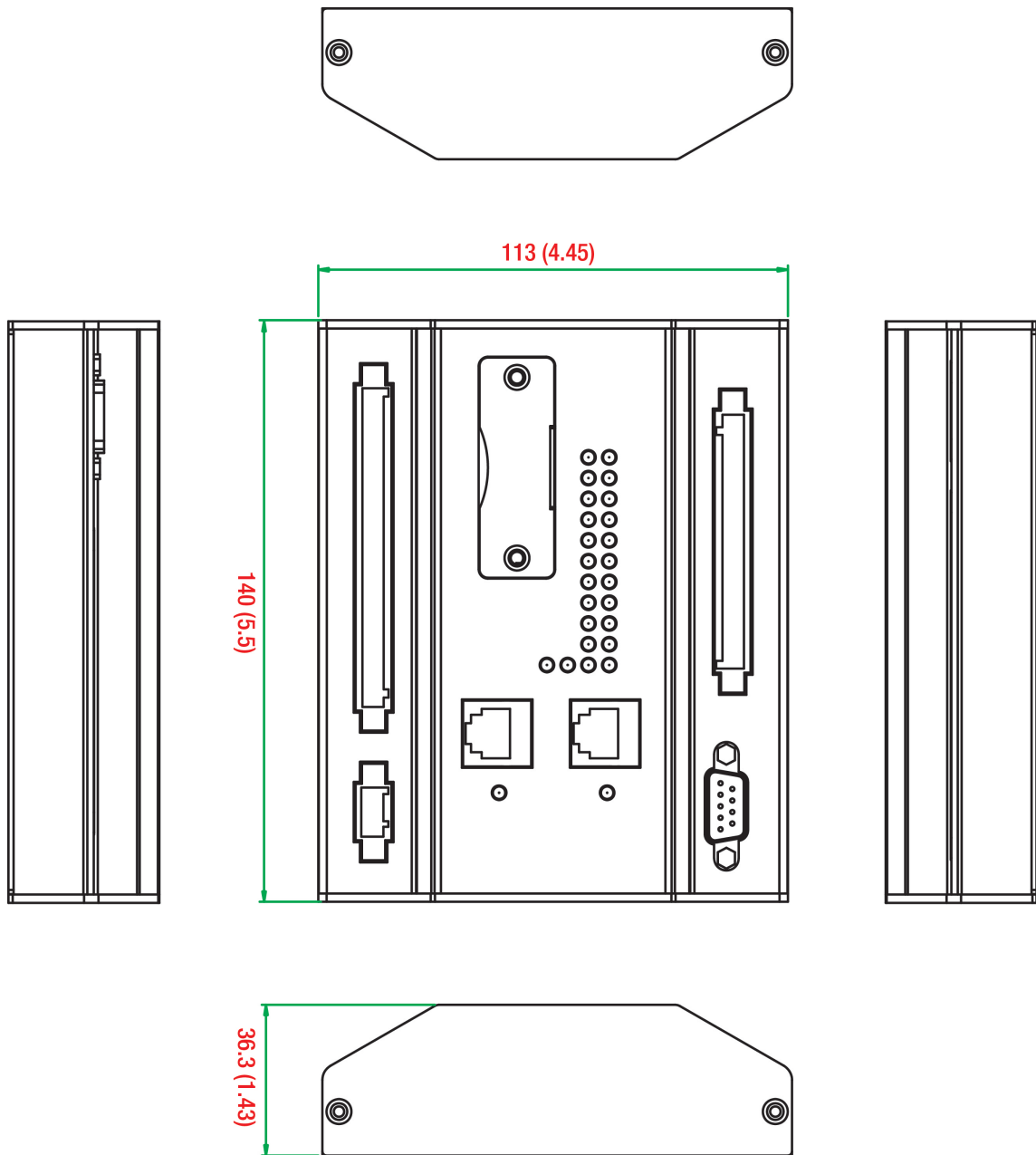

Unit = mm (inch)

ioLogik E1263H

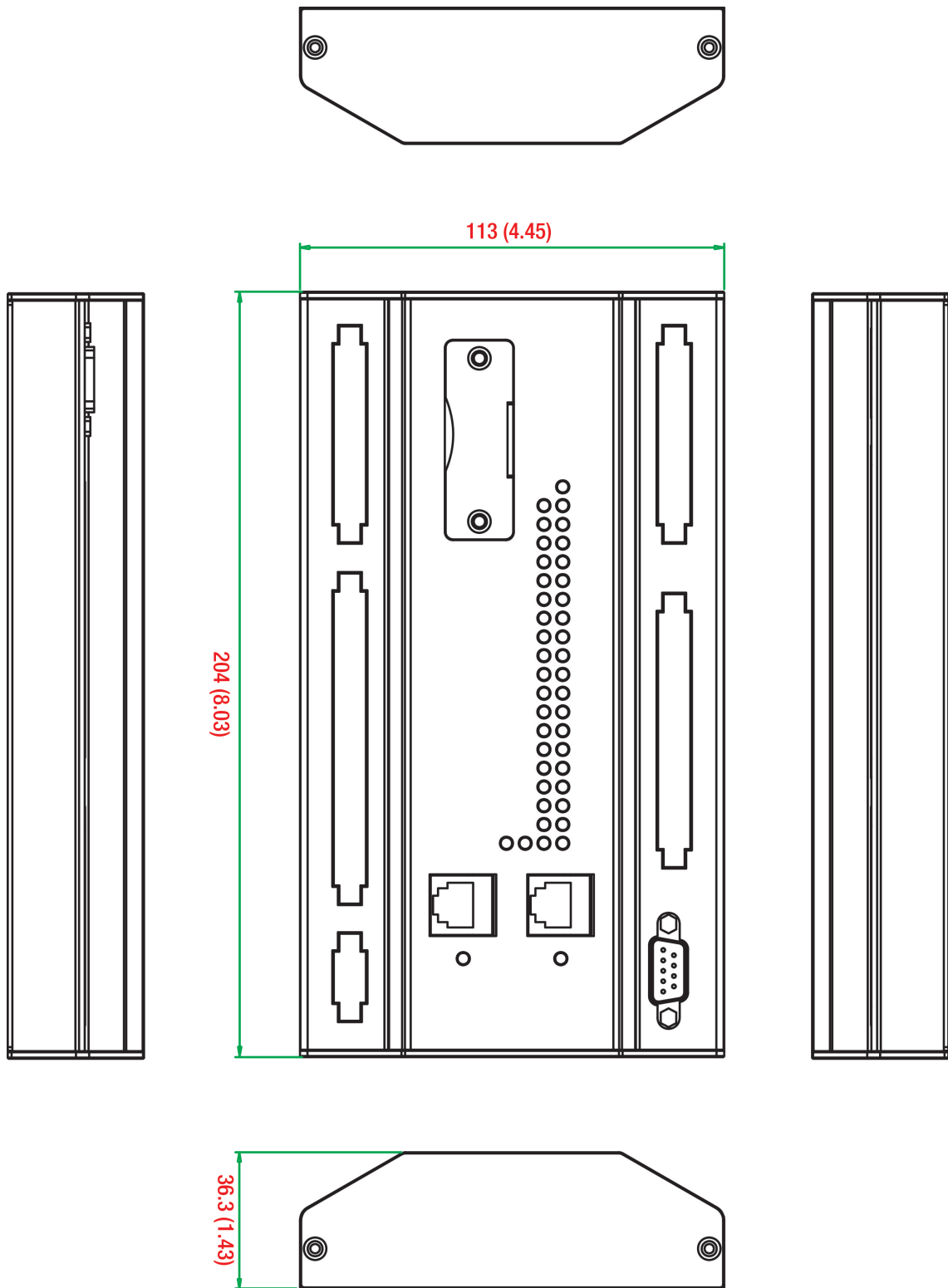

Unit = mm (inch)

Hardware Reference

Panel Guide

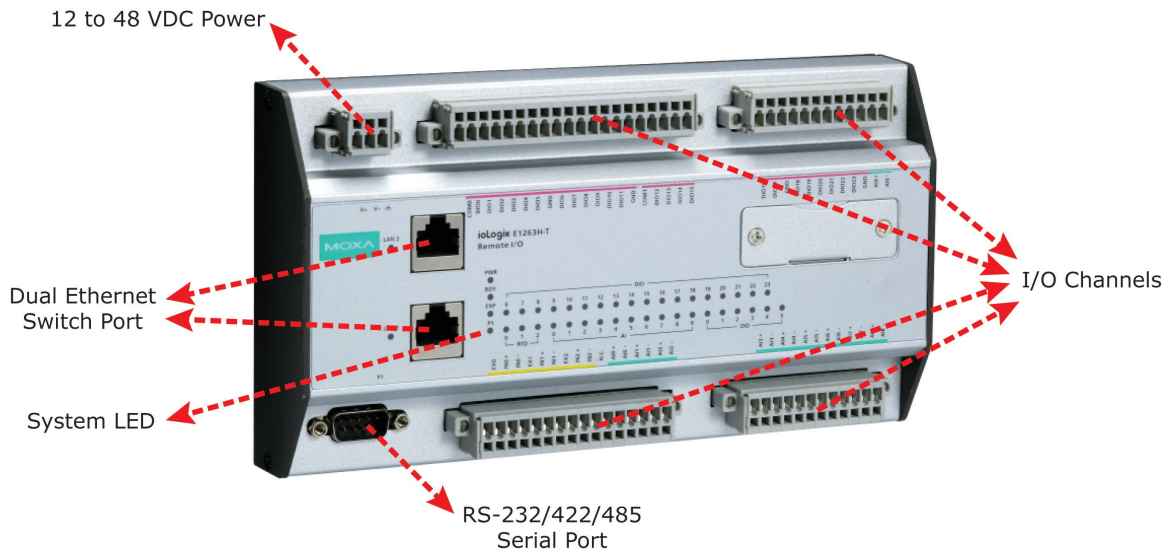

NOTE The reset button restarts the server and resets all settings to factory defaults. Remove the two screws and the aluminum plate on top of the aluminum housing, press and hold down the reset button for 5 sec. The factory defaults will be loaded once the Ready LED turns green again. You may then release the reset button.

LED Indicators

Type	Color	Description
PWR	Green	System power in ON
	Off	System power is OFF
RDY	Green	System is ready
	Green Blinking	Located
	Green/Red Blinking	Safe Mode
	Off	System is not ready
LAN1, LAN2	Green	100Mb
	Amber	10Mb
	Blinking	Data Transmitting
	Off	Ethernet Off
P1	Green	RS-485 Transceiver
	Amber	RS-485 Receiver
	Blinking	Data Transmitting
	Off	RS-485 Off
DIO	Green	Channel ON
	Green Blinking	Counter or Pulse Mode receive input
	Off	Channel OFF
AI	Green	Channel enable
	Red	Burn out (wire off)
	off	Channel disable

2

Initial Setup

This chapter describes how to install the ioLogik E1200H.

The following topics are covered in this chapter:

▣ Hardware Installation

- Connecting the Power
- Grounding the ioLogik E1200H
- Connecting to the Network
- I/O Wiring Diagrams

▣ Software Installation

▣ Load Factory Defaults

Hardware Installation

Connecting the Power

Connect the 12 to 48 VDC power line to the ioLogik E1200H's terminal block on the top panel. If power is properly supplied, the Power LED will glow a solid amber color.



ATTENTION

Disconnect the power cord before installing or wiring your ioLogik E1200H.

Do not exceed the maximum current for the wiring

Determine the maximum possible current for each power wire and common wire. Observe all electrical codes dictating the maximum current allowable for each wire size. If the current exceeds the maximum rating, the wiring could overheat, causing serious damage to your equipment. For safety reasons, the wires attached to the power should be at least 2 mm in diameter.

Grounding the ioLogik E1200H

The ioLogik E1200H is equipped with a grounding point on the terminal block located on the top panel.

Connect the ground pin () if earth ground is available.

Connecting to the Network

The ioLogik E1200H has two built-in Ethernet switch ports for connecting a standard direct or cross-over Ethernet cable from RJ45 port to either the host PC or another ioLogik E1200H device. For initial setup of the ioLogik E1200H, it is recommended that the ioLogik E1200H be configured using a direct connection to a host computer rather than remotely over the network.

Configure the host PC's IP address to 192.168.127.xxx (where xxx ranges from 001 to 253). When using Windows, you will need to do the configuration from the Control Panel.

ioLogik E1200H Default IP Address	Default Netmask	Default Gateway
192.168.127.254	255.255.255.0	None

Use the web console or ioSearch configuration utility to connect to the ioLogik E1200H. Once the ioLogik E1200H has been detected, modify the settings as needed for your network environment, and then restart the server. Refer to Chapters 3 and 4 for further details.

I/O Wiring Diagrams

DI Dry Contact

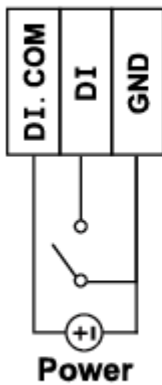

DI Wet Contact

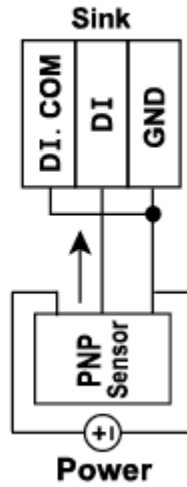
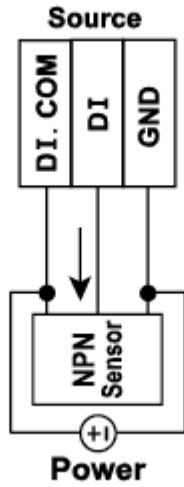

DO (sink)

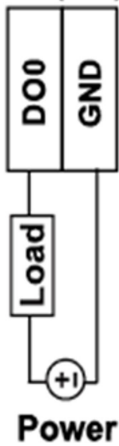

Voltage/Current

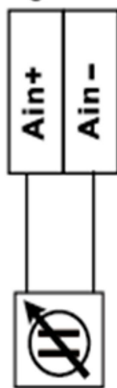

DO (sink)

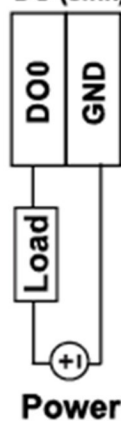

Voltage/Current

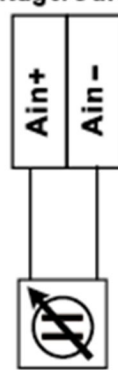

2-Wire RTD

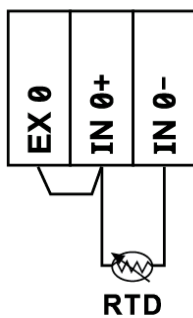

3-Wire RTD

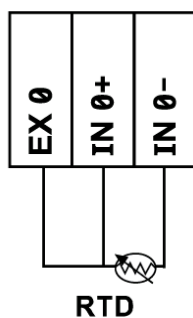

Software Installation

ioSearch is a search utility that helps the user locate ioLogik E1200H devices on the local network. You may download the latest version of ioSearch from Moxa's website.

1. **Installing ioSearch:** Download the ioSearch utility from Moxa's website, double click the installation file, and then follow the installation wizard's instructions to complete the installation. You can also download and install the MXIO DLL library separately.
2. **Open ioSearch:** After installation is finished, run ioSearch from **Start → Program Files → MOXA → IO Server → Utility → ioSearch**
3. **Search the network for the server:** On the menu bar, select **System → Auto Scan Active Ethernet I/O Server**. A dialog window will pop up. Click **Start Search** to begin searching for the ioLogik E1200H.

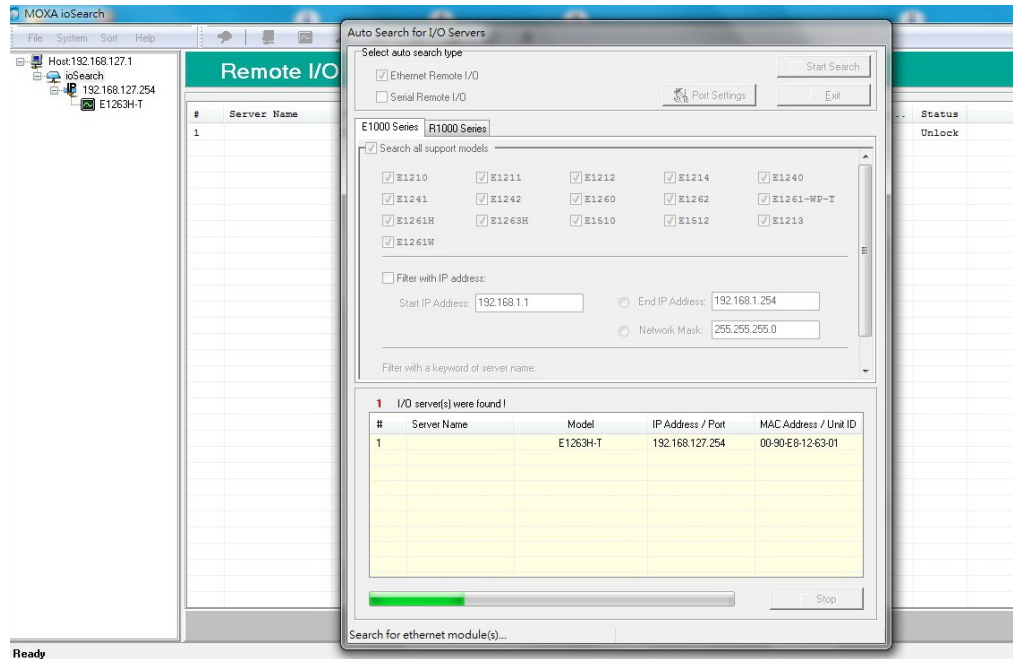

If multiple ioLogik E1200H units are installed on the same network, remember that each unit has the same default IP address. You will need to assign a different IP address to each unit to avoid IP conflicts.

Load Factory Defaults

There are three ways to restore the ioLogik E1200H to the factory defaults.

1. Press and hold the RESET button for 5 seconds (under the reset protection cover).
2. Right-click the specified ioLogik in the ioSearch utility and select **Reset to Default**.
3. Select **Load Factory Default** from the web console

Using the Web Console

The ioLogik E1200H's main configuration and management utility is the built-in web console, which can be used to configure a wide range of options.

The following topics are covered in this chapter:

- ❑ **Introduction to the Web Console**
- ❑ **Overview**
- ❑ **Network Settings**
 - General Settings
 - Ethernet Configuration
- ❑ **User-defined Modbus Addressing**
 - Default Address
- ❑ **AOPC Server Settings**
- ❑ **Tag Generation**
- ❑ **I/O Settings**
 - DI Channels
 - DO Channels
 - AI Channels
 - AI Input Range
 - RTD Channels
- ❑ **System Management**
 - IP Accessibility
 - Network Connection
 - Firmware Update
 - Import System Configuration Settings
 - Export System Configuration Settings
 - RS-485 Configuration
- ❑ **Changing the Password**
- ❑ **Load Factory Defaults**
- ❑ **Save/Restart**

Introduction to the Web Console

The ioLogik E1200H web console is a browser-based configuration utility. When the ioLogik E1200H is connected to your network, you may enter the server's IP address in your web browser to access the web console.

MOXA® ioLogik Remote Ethernet I/O Server www.moxa.com

■ Model - E1263H-T Ethernet IO Server ■ IP - 192.168.127.254 ■ MAC Address - 00-90-e8-12-63-01
 ■ Name - ■ Serial No. - 63001 ■ Firmware - V1.2 Build14032515
 ■ Location - ■ System Elapsed Time - 00:14:18

Welcome to ioLogik Series ↗ Main Window

Remote Ethernet I/O Server

Model Name E1263H-T
Serial Number 63001
Firmware Version V1.2 Build14032515
BIOS Version V1.3.0
Ethernet IP Address 192.168.127.254
Ethernet MAC Address 00-90-e8-12-63-01

I/O Status

DI Channel	Mode	Status	Filter	Counter Trigger
DI-00	DI	OFF	100.0 ms	--
DI-01	DI	OFF	100.0 ms	--
DI-02	DI	OFF	100.0 ms	--
DI-03	DI	OFF	100.0 ms	--
DI-04	DI	OFF	100.0 ms	--
DI-05	DI	OFF	100.0 ms	--
DI-06	DI	OFF	100.0 ms	--
DI-07	DI	OFF	100.0 ms	--
DI-08	DI	OFF	100.0 ms	--
DI-09	DI	OFF	100.0 ms	--
DI-10	DI	OFF	100.0 ms	--
DI-11	DI	OFF	100.0 ms	--

Navigation Panel (Left Panel)

- Main Menu - E1263H-T
 - Overview
 - Network Settings
 - General Settings
 - Ethernet Configuration
 - User-defined Modbus Addressing
 - AOPC Server Settings
 - I/O Settings
 - System Management
 - Serial Settings
 - Change Password
 - Load Factory Default
 - Save/Restart

The left panel is the navigation panel and contains an expandable menu tree for navigating among the various settings and categories. When you click on a menu item in the navigation panel, the main window will display the corresponding options for that item. Configuration changes can then be made in the main window. For example, if you click on **Network Settings** in the navigation panel, the main window will show a page of basic settings that you can configure.

You must click on the **Submit** button after making configuration changes. The **Submit** button will be located at the bottom of every page that has configurable settings. If you navigate to another page without clicking the **Submit** button, your changes will not be retained.

Submitted changes will not take effect until they are saved and the ioLogik E1200H is restarted!

You may save and restart the server in one step by clicking on the **Save/Restart** button after you submit a change. If you need to make several changes before restarting, you may save your changes without restarting by selecting **Save/Restart** in the navigation panel. If you restart the ioLogik E1200H without saving your configuration, the ioLogik E1200H will discard all submitted changes.

Overview

The Overview page contains basic information about the ioLogik E1200H, including the model name, serial number, firmware version, MAC address, and current IP address. Most importantly, you can see the current I/O status by hitting the F5 key on the computer keyboard to refresh the page.

MOXA ioLogik Remote Ethernet I/O Server www.moxa.com

Model	- E1263H-T Ethernet I/O Server	IP	- 192.168.127.254	MAC Address	- 00-90-e8-99-10-01
Name	-	Serial No.	- 09910	Firmware	- V1.0 Build12022214
Location	-	System Elapsed Time	- 00:07:58		

Remote Ethernet I/O Server

Model Name: E1263H-T
Serial Number: 09910
Firmware Version: V1.0 Build12022214
BIOS Version: V1.0.0
Ethernet IP Address: 192.168.127.254
Ethernet MAC Address: 00-90-e8-99-10-01

I/O Status

DI Channel	Mode	Status	Filter	Counter Trigger
DI-00	DI	OFF	100.0 ms	--
DI-01	DI	OFF	100.0 ms	--
DI-02	DI	OFF	100.0 ms	--
DI-03	DI	OFF	100.0 ms	--
DI-04	DI	OFF	100.0 ms	--
DI-05	DI	OFF	100.0 ms	--
DI-06	DI	OFF	100.0 ms	--
DI-07	DI	OFF	100.0 ms	--
DI-08	DI	OFF	100.0 ms	--
DI-09	DI	OFF	100.0 ms	--

Network Settings

General Settings

On the General Settings page, you can assign a server name and location to assist you in differentiating between different ioLogik E1200H units. You may also configure the Modbus/TCP idle interval or enable the Communication Watchdog function.

General Settings

I/O Server Settings

Server Name	<input type="text"/>
Server Location	<input type="text"/>
<input checked="" type="checkbox"/> Enable Server Socket Idle Connection Timeout Interval	<input type="text" value="60"/> sec (1-65535, default = 60, disable = 0)
<input type="checkbox"/> Enable communication watchdog	<input type="text" value="0"/> sec (1-65535, default = 0, disable = 0)
Locate I/O Server	<input type="button" value="Enable I/O Locate"/>

The Communication Watchdog activates Safe Mode after a specified amount of time has passed following a loss of network connectivity. Safe Mode is designed especially for products that have output channels to output a suitable value or status when the ioLogik E1200H cannot be controlled by a remote PC (due to network failure, for example). By default, the Watchdog is disabled. Users can configure how each output channel responds on the I/O Settings page.

To enable the Watchdog, check **Enable connection watchdog**, set the timeout value, and then restart the server. With Watchdog enabled, the ioLogik E1200H will enter Safe Mode after there is a disruption in communication that exceeds the specified time limit.

For easier location of devices when troubleshooting, enable the remote control of LEDs on the E1200H series devices by selecting "Enable I/O Locate, " to allow remote toggling of the "Ready" LED from off to flashing.

Ethernet Configuration

On the Ethernet Configuration page, you can set up a static or dynamic IP address for the ioLogik E1200H, and configure the subnet mask and gateway address.

Ethernet Configuration

Ethernet Parameters

IP Configuration	<input type="text" value="Static"/>
IP Address	<input type="text" value="192.168.127.254"/>
Subnet Mask	<input type="text" value="255.255.255.0"/>
Gateway	<input type="text" value="0.0.0.0"/>

User-defined Modbus Addressing

The input and output address can be configured in a different format on a specific settings page. Check the “Enable User-defined Modbus Addressing” box, select the Modbus function, and then configure the start address of each item.

User-defined Modbus Addressing

Enable User-Defined Modbus Addressing

User-Defined Modbus address							
No.	Description	User-defined Start Address (DEC)	Function Code	Read/Write	Reference Address (DEC)	Total Channels	Data Type
1	DO Value	0000	01:COIL STATUS	RW	00001	24	1 bit
2	DO Pulse Operate Status	0032	01:COIL STATUS	RW	00033	8	1 bit
3	DO Value All Channel (Ch0-Ch23)	0064	03:HOLDING REGISTER	RW	40065	2	1 WORD
4	DI Value	0000	02:INPUT STATUS	R	10001	24	1 bit
5	DI Counter Value (Double Word)	0032	04:INPUT REGISTER	R	30033	8	2 WORD

Submit Load Default



ATTENTION

Disable the user-defined modbus addressing function if using the MXIO(.NET) library or using Active OPC Server to control or monitor the ioLogik E1200H's I/O Status.

Default Address

On this settings page, you can view the default Modbus address for all I/O devices. The page only displays the start address of each item. For example, if the DI Value starts from 10001, then the 1st DI channel's Modbus address is 10001 and the 2nd DI is 10002. Please refer to the diagram at the top of the following page.

Default Modbus Address

Default Modbus address							
No.	Description	User-defined Start Address (DEC)	Function Code	Read/Write	Reference Address (DEC)	Total Channels	Data Type
1	DO Value	0000	01:COIL STATUS	RW	00001	24	1 BIT
2	DO Pulse Operate Status	0032	01:COIL STATUS	RW	00033	8	1 BIT
3	DO Value All Channel(Ch0-Ch23)	0064	03:HOLDING REGISTER	RW	40065	2	1 WORD
4	DI Value	0000	02:INPUT STATUS	R	10001	24	1 BIT
5	DI Counter Value (Double Word)	0032	04:INPUT REGISTER	R	30033	8	2 WORD

AOPC Server Settings

Moxa's Active OPC Server™ is a software package operated as an OPC driver of an HMI or SCADA system. It seamlessly connects Moxa's ioLogik products to a wide variety of SCADA systems, including the most popular: Wonderware, Citect, and iFix. Active OPC Server™ conforms to the OPC Foundation's latest data access standard, DA 3.0, and will connect with other standards-compliant devices and host OPC machines.

Hardware Requirements	
CPU	Intel Pentium 4 and above
RAM	512 MB (1024 MB recommended)
Network Interface	10/100 Mb Ethernet
Software Requirements	
Operating System	Microsoft Windows 2000, XP or later
Editor (not required)	Microsoft Office 2003 (Access 2003) or later
OPC Server Specifications	
OPC Data Access	1.0a, 2.0, 2.05a, 3.0
Max. No. of Tags	5000 (V1.12 or later)

Active OPC Server can be downloaded from the Moxa Website, and may be found from Moxa's online support page, www.moxa.com/support/.

After downloading the AOPC software, unzip it and run **Install.exe**. The installation program will guide you through the installation process and install the Active OPC Server Utility.

For more details on AOPC installation and use, please refer to the Active OPC User's Manual.

Tag Generation

Tag configuration of an ioLogik E1200H is specified by its web console. Open the browser and go to the **Active OPC Server Settings** page.

Follow these steps to create the tag from the ioLogik E1200H to Active OPC Server:

In the AOPC & I/O Settings page,

Check the "Enable Active OPC" box and specify the IP address where the Active OPC Server is installed.

Select the I/O channels that need to be created in the Active OPC Server.

Configure the Heartbeat Interval, if necessary.

Active OPC Server Settings

Enable Active OPC

No.	IP Address	Port
1	192.168.127.201	9900
2		9900

I/O Channel Settings

Update by I/O On Change, Interval 1 sec 1-65535

Enable All DI Channels

Ch00 Ch01 Ch02 Ch03 Ch04 Ch05
 Ch06 Ch07 Ch08 Ch09 Ch10 Ch11
 Ch12 Ch13 Ch14 Ch15 Ch16 Ch17
 Ch18 Ch19 Ch20 Ch21 Ch22 Ch23

Submit

Click the "Submit" button and click the Save/Restart button on the next page.

Configuration Complete!

Warning! The changes will take effect until you Save/Restart the I/O Server.

You can Save / Restart the I/O Server now or Save / Restart the I/O Server when all settings complete.

[Back](#) [Save/Restart](#) [Home](#)

On the Create AOPC Tag page, click on the **Create Tags** button to push the tag configuration to Active OPC Server.

The screenshot shows a web console interface. On the left is a vertical navigation menu with the title "- Main Menu - E1263H(-T)". The menu items are: Overview, - Network Settings, - User-defined Modbus Addressing, - AOPC Server Settings, AOPC & I/O Settings, **Create AOPC Tag** (highlighted with a dashed border), - I/O Settings, - System Management, RS-485 Settings, Change Password, Load Factory Default, and Save/Restart. To the right of the menu is the main content area, titled "Create Active OPC Tag" in green text. Below the title is a single button labeled "Create Tag".

Launch the Active OPC Server program; tags will be automatically created.

Save the configuration of the Active OPC Server when exiting the program.

I/O Settings

DI Channels

The status of each DI (digital input) channel appears on the DI Channels page.

DI Channel Settings

[Refresh page](#)

DI Channel	Mode	Status	Filter	Counter Trigger
DI-00	DI	OFF	100.0 ms	--
DI-01	DI	OFF	100.0 ms	--
DI-02	DI	OFF	100.0 ms	--
DI-03	DI	OFF	100.0 ms	--
DI-04	DI	OFF	100.0 ms	--
DI-05	DI	OFF	100.0 ms	--
DI-06	DI	OFF	100.0 ms	--
DI-07	DI	OFF	100.0 ms	--
DI-08	DI	OFF	100.0 ms	--
DI-09	DI	OFF	100.0 ms	--
DI-10	DI	OFF	100.0 ms	--
DI-11	DI	OFF	100.0 ms	--

You can also configure each channel's digital input mode and parameters by clicking on the channel. DI channels can operate in DI mode or Event Counter mode.

DI Channel 0 Settings

Mode	Filter	Counter Trigger	Counter Start
1. Current Setting			
DI	100		
2. Counter Setting			
3. Safe Status Setting			
4. Save Status On Power Failure			
5. Reset Counter			
6. I/O Direction			
DI			
7. Apply all			
<input type="checkbox"/> Apply to all DI channels			
8. Alias Name			
Alias name of channel			
DI			
Alias name of "OFF" status			
OFF			
Alias name of "ON" status			
ON			
Submit		Close	

For Event Counter mode, configure "Lo to Hi, " "Hi to Lo, " or "Both" to trigger the counter. The counter should be set to either **start**, or **stop**. If it is in **stop** mode, the counter can be activated by the Modbus command. Make sure that the Counter Filter is not set to 0; otherwise, the counter will never be activated.

The alias name and the logic definition can also be configured on this page.

DO Channels

On the DO Channels page, configure each DO (digital output) channel by clicking on the channel. DO Channels can operate in DO mode or Pulse Output mode. In DO mode, output is either on or off. In Pulse Output mode, configure the low width and high width to generate a square wave.

DO Channel Settings

DO Channel	Mode	Status	Low Width	High Width
DO-12	DO	OFF	--	--
DO-13	DO	OFF	--	--
DO-14	DO	OFF	--	--
DO-15	DO	OFF	--	--
DO-16	DO	OFF	--	--
DO-17	DO	OFF	--	--
DO-18	DO	OFF	--	--
DO-19	DO	OFF	--	--
DO-20	DO	OFF	--	--
DO-21	DO	OFF	--	--
DO-22	DO	OFF	--	--
DO-23	DO	OFF	--	--

The **Power On Setting** field is used to specify the channel's configuration when the ioLogik E1200H is powered on, and the **Safe Status Setting** field specifies the channel's configuration when the ioLogik E1200H enters Safe Mode. Note that Safe Status is controlled by the Connection Watchdog, which is disabled by default. If the Connection Watchdog is disabled, the ioLogik E1200H will never enter Safe Mode and your Safe Status settings will have no effect.

DO Channel 0 Settings

Mode	DO Status	ON Width*	OFF Width*	Pulse Count	Pulse Start
[1. Current Setting]:					
DO <input type="button" value="v"/>	OFF <input type="button" value="v"/>				
[2. Pulse Output Setting]:					
DO <input type="button" value="v"/>	OFF <input type="button" value="v"/>				
[3. Safe Status Setting]:					
	OFF <input type="button" value="v"/>				
[4. I/O Direction]:					
DO <input type="button" value="v"/>					
[5. Apply all]:					
<input type="checkbox"/> Apply to all DO channels					
[6. Alias Name]:					
Alias name of channel					
<input type="text" value="DO"/>					
Alias name of "OFF" status					
<input type="text" value="OFF"/>					
Alias name of "ON" status					
<input type="text" value="ON"/>					

***NOTE: Pulse width unit = 1 ms, range = 1-65535.**

WARNING: Be sure to Save/Restart your settings.

Users may also configure aliases and logic definitions on this page.

AI Channels

The current status of each AI (analog input) channel can be viewed on the AI Channels page.

AI Channel Settings

AI Channel	Range	Value	Min.	Max.
AI-00	0-10V	0.010V	0.007V	0.010V
AI-01	0-10V	0.009V	0.009V	0.012V
AI-02	0-10V	0.009V	0.006V	0.009V
AI-03	0-10V	0.007V	0.007V	0.010V
AI-04	0-10V	0.010V	0.010V	0.013V
AI-05	0-10V	0.009V	0.009V	0.012V
AI-06	0-10V	0.008V	0.008V	0.011V
AI-07	0-10V	0.009V	0.009V	0.012V

Click on a specific channel to enable or disable the AI channel by checking the "Enable AI Channel" box. **Auto Scaling** and **Slope-intercept** functions of the AI value can be defined on this page.

AI Channel 0 Settings

Enable AI Channel

AI Input Range

0-10V

X Settings (Only "4-20mA BurnOut")

0.000 (0.000 - 4.000 mA)

* (0 < X (mA), RAW Data=0)

Auto Scaling Settings

Disable Scaling

Enable Point-Slope formula

	Actual (x.xxx)		Scaled (x.xxx)
Min (n1)	<input type="text"/>	Min (n2)	<input type="text"/>
Max (m1)	<input type="text"/>	Max (m2)	<input type="text"/>
Unit	<input type="text"/>	Unit	<input type="text"/>

*Result = n2 + (input - n1) × [(m2-n2)/(m1-n1)]

Enable Slope-intercept

M=

D=

Unit

*Result = M × Input + D

Apply to All Channels

Alias Name Settings

Alias Name of Channel

AI Input Range

There are four modes in the analog input range: [0-10 V], [4-20 mA], [0-20 mA], [4-20 mA (burnout)], **only [0-10 V] and [4-20 mA] supports peer to peer networking.**

AI Channel 0 Settings

Enable AI Channel

AI Input Range

4-20mA (Burn Out) (0.000 - 4.000 mA) only available on BO mode

4-20mA

4-20mA (Burn Out) B=0)

0-20mA

Burnout mode can indicate if the current analog input has burnt out.

The 4-20 mA burnout mode is defined in the diagram at the top of the following page:

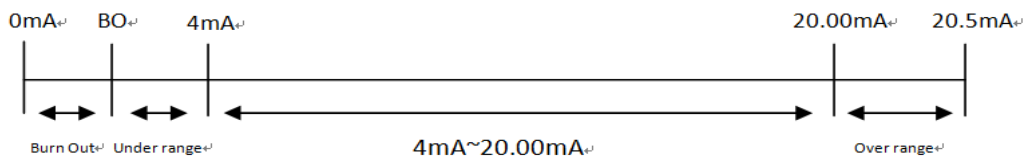

Users can define burnout values (BO, default 2mA) for selected ranges. When input values are in the burnout range, raw data will register as 0000h to indicate analog input burnout. The definition of raw data is as follows:

Burnout Value (BO): $0.0 < BO < 4.0$, user defined (default 2mA)

Burnout State: $0 \leq AI < BO$ mA, S/W output 0000h

Under range: $BO \leq AI < 4$ mA, S/W output raw data

Normal range: $4 \leq AI \leq 20.00$ mA, S/W output raw data until FFFh.

Over range: > 20.00 mA, S/W output FFFFh

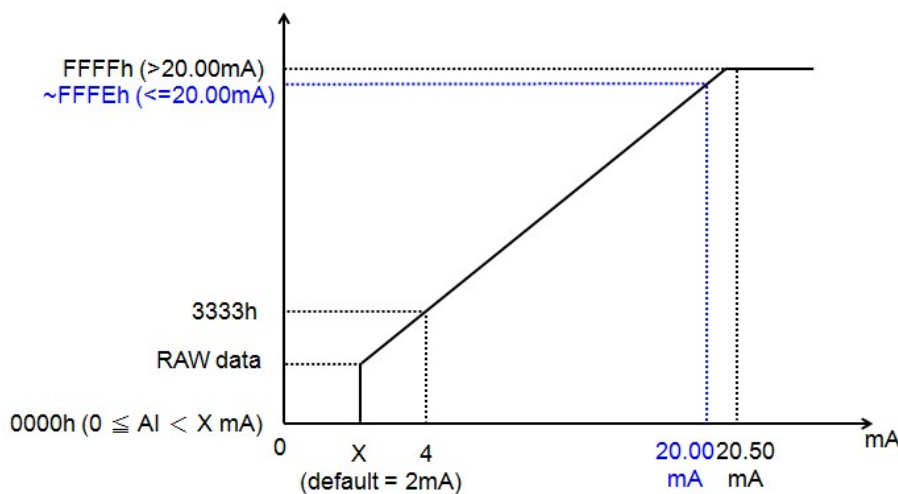

The **Auto scaling** function maps the original AI value linearly to a scaled value. Note that the scaled value's Modbus address differs from the original value.

Auto Scaling Settings

- Disable Scaling
 Enable Point-Slope formula

	Actual (x.xxx)		Scaled (x.xxx)
Min (n1)	<input type="text" value="0.000"/>	Min (n2)	<input type="text" value="0.000"/>
Max (m1)	<input type="text" value="10.000"/>	Max (m2)	<input type="text" value="1000.000"/>
Unit	<input type="text" value="V"/>	Unit	<input type="text" value="ppm"/>

*Result = $n2 + (\text{input} - n1) \times [(m2-n2)/(m1-n1)]$

The slope-intercept function is used to compensate when the measurement requires a slight adjustment.

- Enable Slope-intercept

M=	<input type="text" value="1.1"/>
D=	<input type="text" value="0.02"/>
Unit	<input type="text" value="V"/>

*Result = $M \times \text{Input} + D$

RTD Channels

The current status of each RTD (Resistance Temperature Detector) channel can be viewed on the RTD Channel page.

RTD Channel Settings

RTD Channel	Sensor Type	Range	Status	Value	Min	Max
RTD-00	PT 100	-200 ~ 850°C	Enabled	--	--	--
RTD-01	PT 100	-200 ~ 850°C	Enabled	--	--	--
RTD-02	PT 100	-200 ~ 850°C	Enabled	--	--	--

Click on a specific channel to access the RTD channel settings.

Select the "Enable RTD Channel" box and then select the sensor type that meets the physical attachment to the ioLogik E1200H.

RTD Channel 0 Settings

Enable RTD Channel

RTD Sensor Type	Range	Unit
PT 100 ($\alpha = 0.00385$)	-200 ~ 850	°C

Apply to All Channels

Alias Name Settings

Alias Name of Channel

WARNING: Be sure to Save/Restart your settings

The ioLogik E1200H allows you to calibrate the temperature sensors. In each channel configuration section, follow the instructions and click **Calibrate** button to start the RTD sensor calibration. Each calibration requires around 30 seconds (per channel).

Calibration

Select Channel :

Sensor Type:

1. Ensure the sensor is connected.
2. Ensure the channel and its sensor type is correctly selected.
3. Put the sensor into a glass that contains a mixture of ice and water.
4. Click on the "Calibrate" button.
5. Wait until the page shows "Calibration Completed".

NOTE:

1. Do not remove the sensor from the ice water during calibration.
2. Load factory default will clear the current calibrated settings.

NOTE: Resistance types of sensors are not supported to be calibrated.

The ioLogik E1200H allows you to manually adjust the current temperature reading. In each channel configuration section, select the channel, apply the offset value, and click the "Submit" button to perform the task.

Offset

Channel	Offset	Unit
Select Channel : Channel 0 ▾	1.8	°C
<input type="button" value="Submit"/>	<input type="button" value="Home"/>	

NOTE: Offset range: -1000.0 to +1000.0, unit = 0.1 °C/°F.

System Management

IP Accessibility

You can control network access to the ioLogik E1200H from the IP Accessibility page by only allowing access from specific IP addresses. When the accessible IP list is enabled, a host's IP address must be listed in order to gain access to the ioLogik E1200H.

Accessibility IP List

Enable the accessibility IP List (if unchecked, all connection requests will be accepted.)

No.	Enable	IP Address	Netmask
1	<input checked="" type="checkbox"/>	192.168.127.253	255.255.255.255
2	<input checked="" type="checkbox"/>	192.168.1.0	255.255.255.0
3	<input type="checkbox"/>	0.0.0.0	255.255.255.0
4	<input type="checkbox"/>	0.0.0.0	255.255.255.0
5	<input type="checkbox"/>	0.0.0.0	255.255.255.0
6	<input type="checkbox"/>	0.0.0.0	255.255.255.0
7	<input type="checkbox"/>	0.0.0.0	255.255.255.0
8	<input type="checkbox"/>	0.0.0.0	255.255.255.0
9	<input type="checkbox"/>	0.0.0.0	255.255.255.0
10	<input type="checkbox"/>	0.0.0.0	255.255.255.0

Specify a range of addresses by using a combination of an IP address and netmask, as follows:

To allow access to a specific IP address

Enter the IP address in the corresponding field; enter **255.255.255.255** for the netmask.

To allow access to hosts on a specific subnet

For both the IP address and netmask, use **0** for the last digit (e.g., **192.168.1.0** and **255.255.255.0**).

To allow unrestricted access

Deselect the **Enable the accessible IP list** option.

Refer to the following table for additional configuration examples.

Allowed Hosts	IP address/Netmask
Any host	Disable
192.168.1.120	192.168.1.120 / 255.255.255.255
192.168.1.1 to 192.168.1.254	192.168.1.0 / 255.255.255.0
192.168.0.1 to 192.168.255.254	192.168.0.0 / 255.255.0.0
192.168.1.1 to 192.168.1.126	192.168.1.0 / 255.255.255.128
192.168.1.129 to 192.168.1.254	192.168.1.128 / 255.255.255.128

Network Connection

TCP connections from other hosts appear on the Network Connection page. This information can assist you with managing your devices.

Network Connection

Total TCP/IP Connection(s)	
1	
Source Host Address	Connection Type
192.168.19.201	Web/HTTP

Firmware Update

Load new or updated firmware onto the ioLogik from the Firmware Update page.

Firmware Update

Choose a new firmware file path :

D:\FWR_E1263H_V1.2_Build14032515_STD.1kp

WARNING:

1. The firmware update process may take a few minutes.
2. NOTE! Once you click the "Update" button, the update process cannot be canceled.
3. DO NOT DISCONNECT POWER OR NETWORK CABLE during the update process, since doing so could cause the firmware to become corrupted.

Import System Configuration Settings

Import a configuration into the ioLogik server from the Import System Config page. This function can be used to duplicate settings between ioLogik servers. You will be prompted for the location of the configuration file (i.e., "ik1261.txt").

Import System Configuration File

Update network settings (IP, Gateway, etc.)

Choose a system configuration file path :

C:\Users\Wayne_Chen\Desktop\jk1263H.txt

WARNING:

1. The file import process could take up to 10 seconds.
2. DO NOT DISCONNECT POWER OR NETWORK CABLE during the upload process, since doing so could cause the system to become corrupted.

Export System Configuration Settings

On the Export System Config page, you can save the ioLogik's configuration into a file for backup or import into another ioLogik server.

Export System Settings

Click "[lk1263H.txt](#)" to export & save system settings.

RS-485 Configuration

The RS-485 port is used to communicate with other RS-485 devices or to link to another ioLogik RS-485 I/O server. The RS-485 port can run Modbus/RTU or I/O command sets. The baudrate is set under the RS-485 Setting. The default settings are baudrate = 115200, parity check = N, data bits = 8, and stop bit = 1.

RS-485 Configuration

RS-485 Parameters

Modbus ID	<input type="text" value="1"/>
Baud rate	<input type="text" value="115200"/>
Data bit	<input type="text" value="8"/>
Stop bit	<input type="text" value="1"/>
Parity	<input type="text" value="none"/>

Changing the Password

For all changes to the ioLogik E1200H's password protection settings, you will first need to enter the old password. Leave this blank if you are setting up password protection for the first time. To set up a new password or change the existing password, enter your desired password under both **New password** and **Confirm password**. To remove password protection, leave the **New password** and **Confirm password** fields blank.

Change Password

Password

Old password :	<input type="password" value="...."/>
New password :	<input type="password" value=".."/>
Retype password :	<input type="password" value=".."/>



ATTENTION

If you forget the password, the ONLY way to configure the ioLogik E1200H is by using the reset button to load the factory defaults.

Before you set a password for the first time, it is a good idea to export the configuration to a file when you have finished setting up your ioLogik E1200H. Your configuration can then be easily imported back into the ioLogik E1200H if you need to reset the ioLogik E1200H due to a forgotten password or for other reasons.

Load Factory Defaults

This function will reset all of the ioLogik E1200H's settings to the factory default values. All previous settings, including the console password will be lost.

Load Factory Default

This function will reset the I/O Server settings to their factory default values. Current settings will be overwritten.

Save/Restart

If you change the configuration, do not forget to reboot the system.

Save/Restart

The configuration has been changed. Click Submit to reboot with the new configuration.

WARNING: Rebooting will disconnect your Ethernet connections and some data loss may occur.

This chapter describes ioSearch, which is used to search for and locate ioLogik E1200H units.

The following topics are covered in this chapter:

▣ **Introduction to ioSearch**

▣ **ioSearch Main Screen**

- Main Screen Overview

▣ **Main Items**

- System
- Sort
- Quick Links

▣ **Main Function**

- Locate
- Firmware Upgrade
- Unlock
- Import
- Export
- Change IP Address
- Batch TCP/IP Configuration on Multiple Devices
- Restart System
- Reset to Default
- Mass Deployment (Import)
- Mass Deployment (export)

Introduction to ioSearch

ioSearch is for locating or searching for an Logik E1200H on the physical network. The following functions are supported by the ioSearch utility.

- Search for and locate ioLogik E1200H units.
- IP address configuration.
- Firmware upgrade for multiple ioLogik E1200H units (same model).
- Export configuration files from multiple ioLogik E1200H units.
- Import a configuration file to multiple ioLogik E1200H units (same model).
- Reset to default for multiple ioLogik E1200H units.

ioSearch Main Screen

Main Screen Overview

The main screen displays the result of the broadcast search of the ioLogik E1200H.

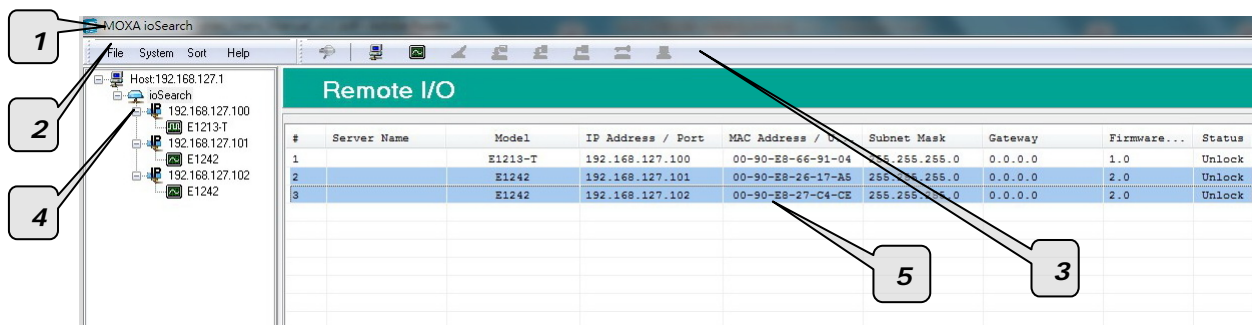

ioSearch Main Screen
1. Title
2. Menu bar
3. Quick link
4. Navigation panel
5. Main window

Main Items

System

Several operations are possible from the **System** menu.

Auto Scan Active Ethernet I/O Servers will search for ioLogik servers on the network. When connecting for the first time or recovering from a network disconnection, you can use this command to find I/O servers that are on the network.

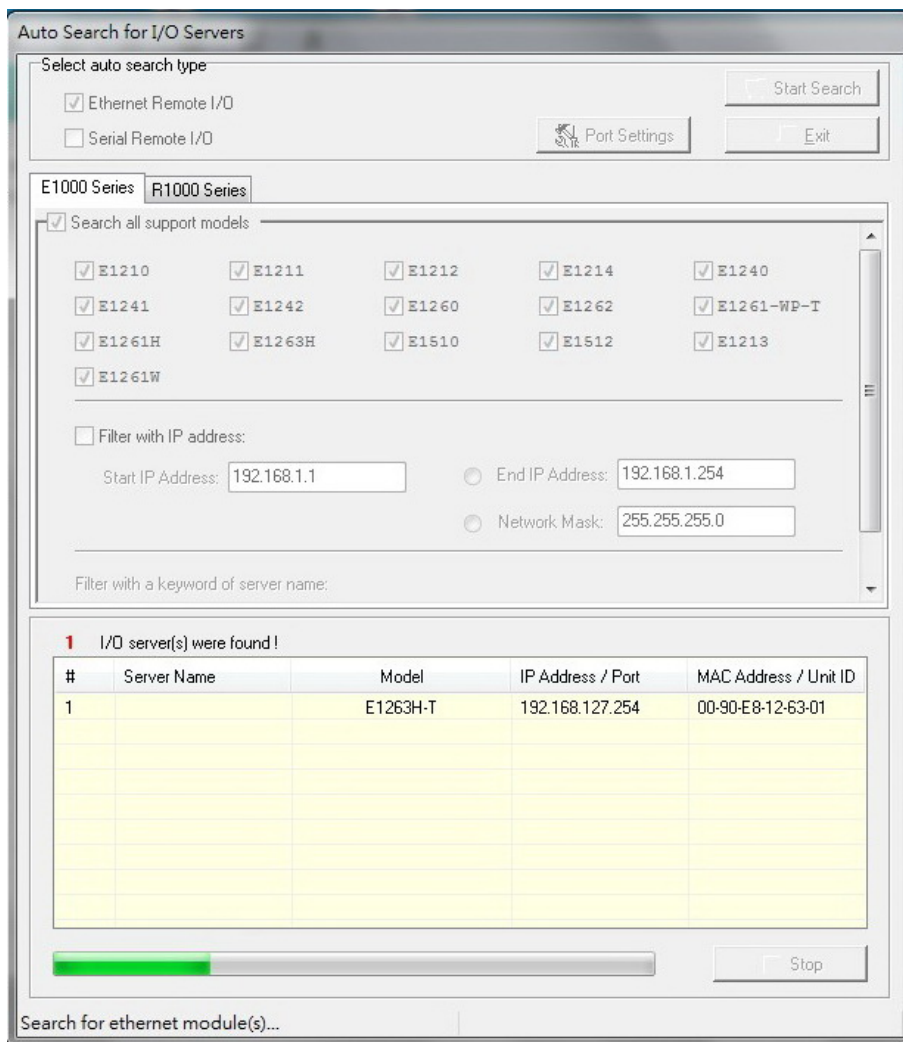

Network Interface allows you to select a network to use, if the PC has multiple network adaptors installed.

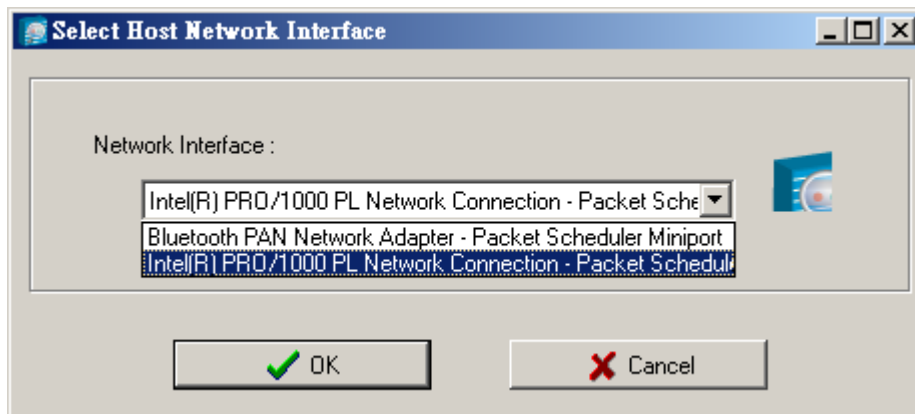

Sort

The **Sort** menu allows the server list in the navigation panel to be sorted by ioLogik connection and server (model).

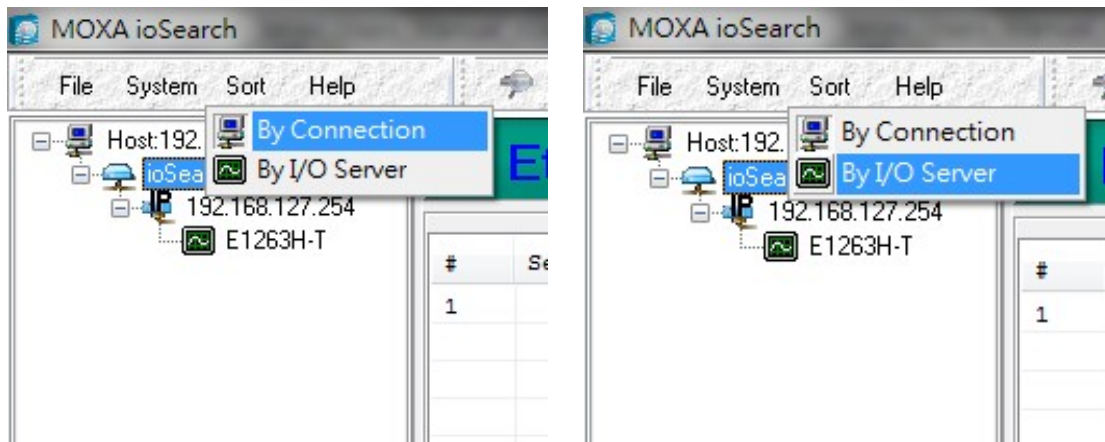

Quick Links

Quick links are provided to search for I/O servers on the network and sort the server list.



1	Automatically search the local network
2	Sort by ioLogik E1200H's IP address (connection)
3	Sort by ioLogik E1200H model
4	Locate an ioLogik E1200H
5	Upgrade Firmware
6	Import settings
7	Export settings
8	Unlock an ioLogik E1200H which is password protected
9	Change IP Address of an ioLogik E1200H

Main Function

Right click on a particular ioLogik E1200H to view the ioSearch function menu.

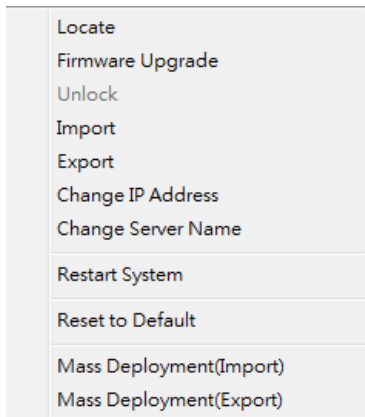

Locate

The locate function helps users find a dedicated ioLogik on the network. When this function is triggered, the ready LED on the selected unit will start to blink indicating its location.



Firmware Upgrade

The ioLogik E1200H supports a remote firmware upgrade function. Enter the path to the firmware file or click on the icon to browse for the file. The wizard will lead you through the process until the server is restarted.

Batch Upgrades on Multiple Devices of the Same Model

Batch firmware upgrades are possible on multiple devices of the same ioLogik model. To upgrade multiple models, press the "Shift" key, select "ioLogik", and right click to process multiple firmware upgrades.

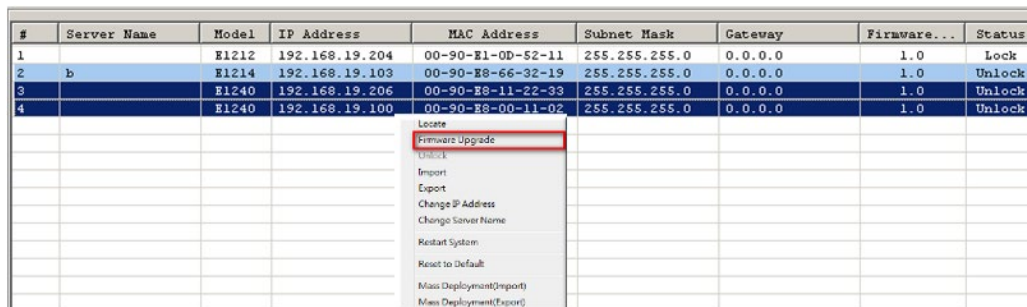

ATTENTION

Do not interrupt the firmware update process! An interruption in the process may result in your device becoming unrecoverable.

Unlock

If an ioLogik E1200H is password protected, unlock the ioLogik E1200H by entering the password before using any of the functions.

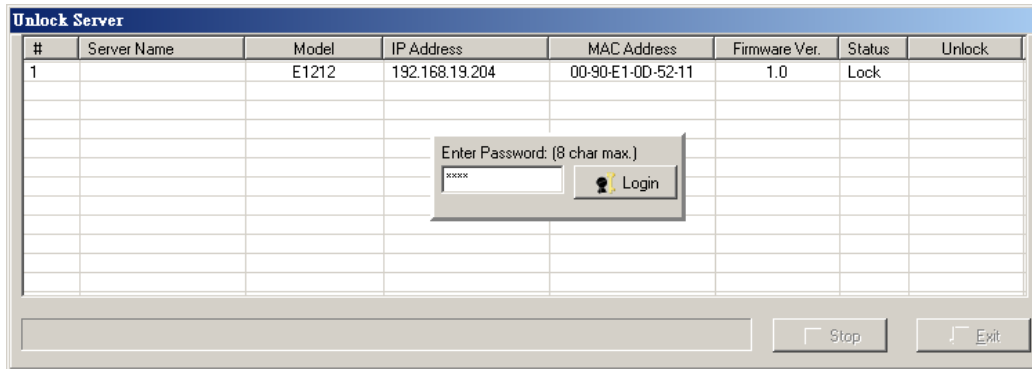

Import

Select this command to reload a configuration that was exported to a text file.

Importing one configuration file to multiple ioLogik E1200H units (same model) is allowed. To do this, press the "Shift" key, select "ioLogik", and then right click.

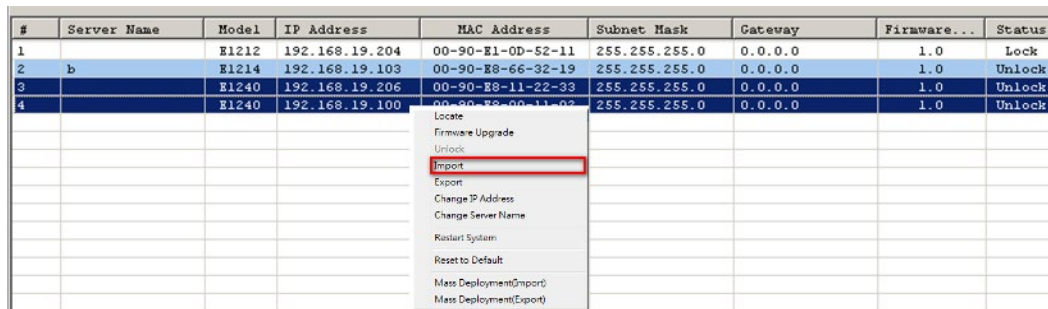

Export

The export function is used to export the current configuration file of an ioLogik E1200H. The export file format will be **ik12xx.txt** where "xx" represents the model type of the ioLogik E1200H.

Exporting multiple files for different models of ioLogik E1200H is allowed. The file format is **ik12xx_MAC Address.txt**, where the xx represents the model types of the ioLogik E1200H.

e.g., ik1214_00-90-E8-66-32-19.txt

To export multiple configuration files, select the ioLogik and right click to process this function.

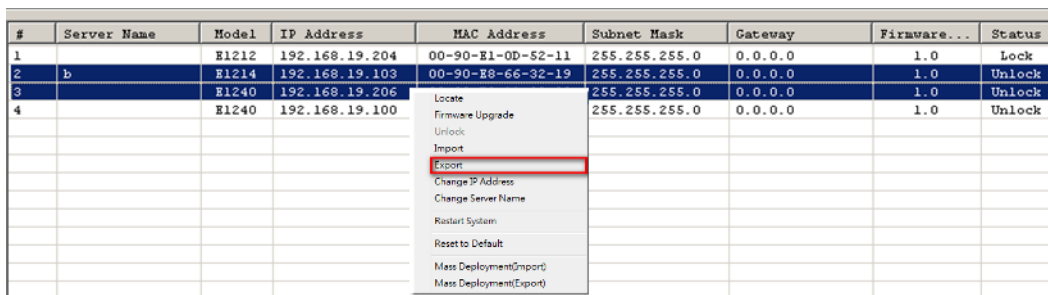

Change IP Address

The Change IP Address function can be used to directly modify the IP Address, especially for first time installation.

Changing the IP address for multiple ioLogik E1200H's is allowed. Select the ioLogik E1200H and then right click to process this function.

#	Server Name	Model	IP Address	MAC Address	Subnet Mask	Gateway	Firmware...	Status
1		E1212	192.168.19.204	00-90-E1-0D-52-11	255.255.255.0	0.0.0.0	1.0	Lock
2	b	E1214	192.168.19.103	00-90-E8-66-32-19	255.255.255.0	0.0.0.0	1.0	Unlock
3		E1240	192.168.19.206	00-90-E8-11-22-33	255.255.255.0	0.0.0.0	1.0	Unlock
4		E1240	192.168.19.100	00-90-E8-11-22-33	255.255.255.0	0.0.0.0	1.0	Unlock

#	Server Name	Model	IP Address	MAC Address	Firmware Ver.	Status	Change IP
1	b	E1214	192.168.19.103	00-90-E8-66-32-19	1.0	Unlock	
2		E1240	192.168.19.206	00-90-E8-11-22-33	1.0	Unlock	Set

Batch TCP/IP Configuration on Multiple Devices

Users can batch modify IP addresses, subnet masks, and gateways for devices of the same model from a single window while submitting the changes at one time. First, select several devices of the same model, click the right mouse button, and then click "Change IP Address" in the pop-up menu to launch a new window.

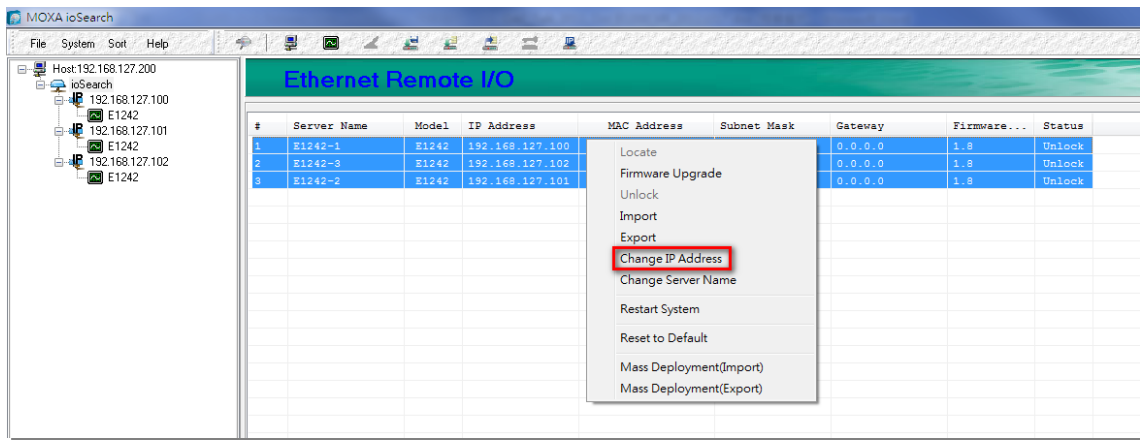

The following screenshot shows the window used to modify IP addresses, subnet masks, and gateways. Users can modify each item and click "Set" to confirm the modification, or click the "Advance" button to automatically assign IP addresses incrementally.

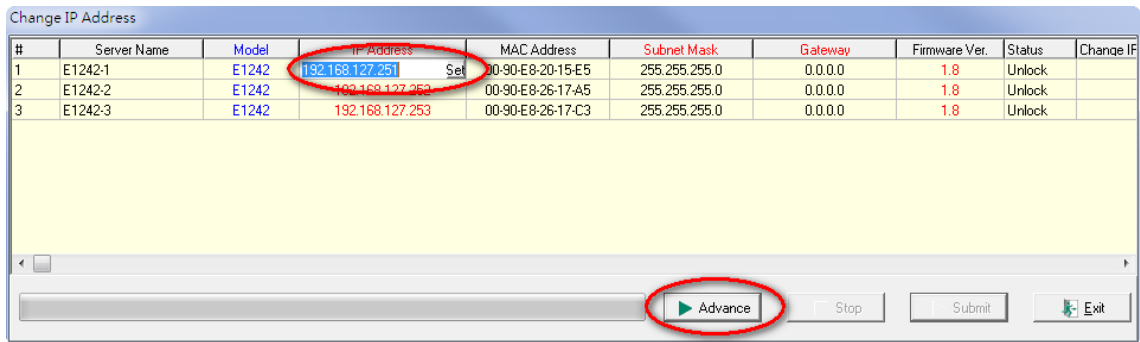

After the “Advance” button is clicked, a window will pop up to allow users to use ioSearch to set the IP address by MAC address. ioSearch will automatically set sequential IP addresses on the selected devices, with the subnet mask and gateway set to the same value.

Restart System

Select this command to restart the selected ioLogik E1200H.

Restarting multiple ioLogik E1200H units is allowed. Select the ioLogik E1200H and right click to process this function.

#	Server Name	Model	IP Address	MAC Address	Subnet Mask	Gateway	Firmware...	Status
1		E1212	192.168.19.204	00-90-E1-0D-52-11	255.255.255.0	0.0.0.0	1.0	Lock
2	b	E1214	192.168.19.103	00-90-E8-66-32-19	255.255.255.0	0.0.0.0	1.0	Unlock
3		E1240	192.168.19.206		255.255.255.0	0.0.0.0	1.0	Unlock
4		E1240	192.168.19.100		255.255.255.0	0.0.0.0	1.0	Unlock

#	Server Name	Model	IP Address	MAC Address	Firmware Ver.	Status	Restart
1	b	E1214	192.168.19.103	00-90-E8-66-32-19	1.0	Unlock	Success
2		E1240	192.168.19.206	00-90-E8-11-22-33	1.0	Unlock	

Restarting I/O Server

Wait for IO server to restart. 3

Stop Exit

Reset to Default

Select this function to reset all settings, including console password, to factory default values.

Resetting multiple ioLogik E1200H units to the default configuration is allowed. Select the ioLogik E1200H and right click to process this function.

#	Server Name	Model	IP Address	MAC Address	Subnet Mask	Gateway	Firmware...	Status
1		E1212	192.168.19.204	00-90-E1-0D-52-11	255.255.255.0	0.0.0.0	1.0	Lock
2	b	E1214	192.168.19.103	00-90-E8-66-32-19	255.255.255.0	0.0.0.0	1.0	Unlock
3		E1240	192.168.19.206		255.255.255.0	0.0.0.0	1.0	Unlock
4		E1240	192.168.19.100		255.255.255.0	0.0.0.0	1.0	Unlock

#	Server Name	Model	IP Address	MAC Address	Subnet Mask	Gateway	Firmware...	Status
1		E1212	192.168.19.204	00-90-E1-0D-52-11	255.255.255.0	0.0.0.0	1.0	Lock
2	b	E1214	192.168.19.103	00-90-E8-66-32-19	255.255.255.0	0.0.0.0	1.0	Unlock
3		E1240	192.168.19.206		255.255.255.0	0.0.0.0	1.0	Unlock
4		E1240	192.168.19.100		255.255.255.0	0.0.0.0	1.0	Unlock

Mass Deployment (Import)

Users can import E1200H series module information via ioSearch. Select this command to reload a configuration from an exported.CSV file.

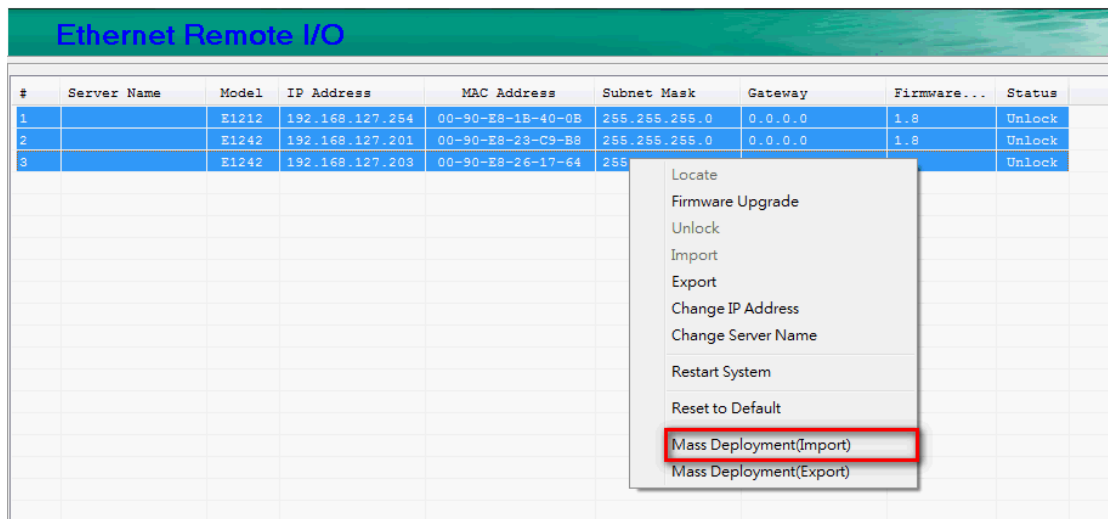

The screenshot shows the 'Ethernet Remote I/O' interface with a table of server information. A context menu is open over the table, and the 'Mass Deployment(Import)' option is highlighted with a red box.

#	Server Name	Model	IP Address	MAC Address	Subnet Mask	Gateway	Firmware...	Status
1		E1212	192.168.127.254	00-90-E8-1B-40-0B	255.255.255.0	0.0.0.0	1.8	Unlock
2		E1242	192.168.127.201	00-90-E8-23-C9-B8	255.255.255.0	0.0.0.0	1.8	Unlock
3		E1242	192.168.127.203	00-90-E8-26-17-64	255			Unlock

- Locate
- Firmware Upgrade
- Unlock
- Import
- Export
- Change IP Address
- Change Server Name
- Restart System
- Reset to Default
- Mass Deployment(Import)**
- Mass Deployment(Export)

Mass Deployment (export)

Users can export E1200H series module information via ioSearch. The export file format will be **E1200H_Series_List**.

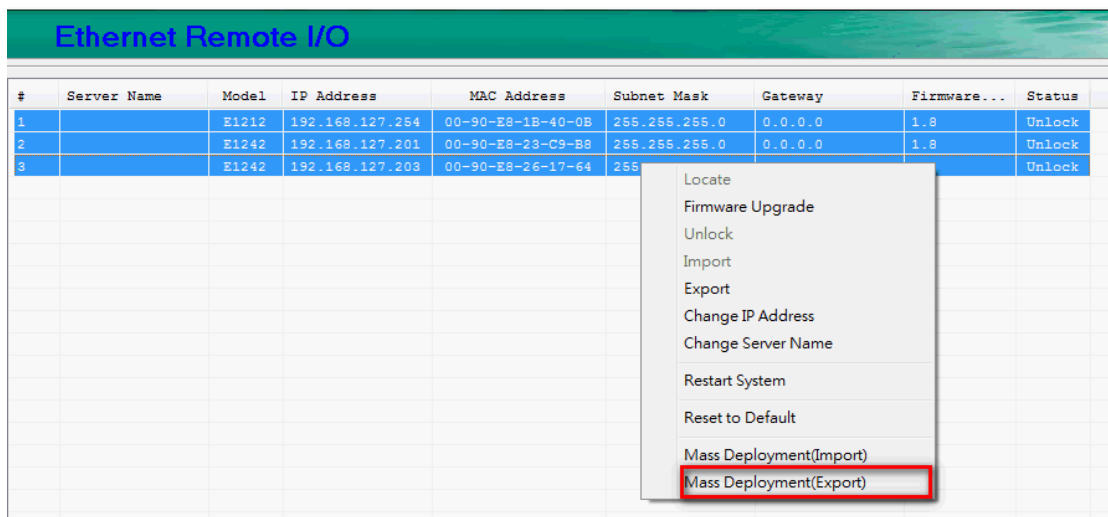

The screenshot shows the 'Ethernet Remote I/O' interface with a table of server information. A context menu is open over the table, and the 'Mass Deployment(Export)' option is highlighted with a red box.

#	Server Name	Model	IP Address	MAC Address	Subnet Mask	Gateway	Firmware...	Status
1		E1212	192.168.127.254	00-90-E8-1B-40-0B	255.255.255.0	0.0.0.0	1.8	Unlock
2		E1242	192.168.127.201	00-90-E8-23-C9-B8	255.255.255.0	0.0.0.0	1.8	Unlock
3		E1242	192.168.127.203	00-90-E8-26-17-64	255			Unlock

- Locate
- Firmware Upgrade
- Unlock
- Import
- Export
- Change IP Address
- Change Server Name
- Restart System
- Reset to Default
- Mass Deployment(Import)
- Mass Deployment(Export)**

A

Modbus/TCP Default Address Mappings

The following topics are covered in this appendix:

- **E1261H Modbus Mapping**
- **E1263H Modbus Mapping**

NOTE The Modbus/TCP ID of the ioLogik E1200H is set to "1" by default.

E1261H Modbus Mapping

Fixed + Dynamic Default addresses

Func Code	Ref. Address	Address	Channel Num	Data type	R/W	Description
1 or 101	0xxxx	0x0000	12	1 bit	R/W	DO Value
1 or 101	0xxxx	0x0020	8	1 bit	R/W	DO Pulse Operate Status
1 or 101	0xxxx	0x0100	8	1 bit	R/W	DI Counter Start
1 or 101	0xxxx	0x0120	8	1 bit	R/W	DI Counter Clear
1 or 101	0xxxx	0x0300	24	1 bit	R/W	DIO Direction (DIO0-DIO11)
2 or 102	1xxxx	0x0000	12	1 bit	R	Get DI Value
4 or 104	3xxxx	0x0000	12	1 word	R	Get DI WordValue
4 or 104	3xxxx	0x0020	8	2 word	R	Get DI Counter Value Hi&Low Word
4 or 104	3xxxx	0x0040	NA	1 word	R	GET DI Value all Channel (Ch0~11)
4 or 104	3xxxx	0x0200	5	1 word	R	Read AI Value (Raw data)
4 or 104	3xxxx	0x0210	5	2 word	R	Read AI Value Scaling (float)
4 or 104	3xxxx	0x0230	5	1 word	R	Read AI current Mode Status
4 or 104	3xxxx	0x0600	3	1 word	R	RTD Value
3 or 103	4xxxx	0x0000	12	1 word	R/W	DO Value
3 or 103	4xxxx	0x0020	8	1 word	R/W	DO Pulse Operate Status
3 or 103	4xxxx	0x0040	NA	1 word	R/W	DO WordValue (Ch0-11)
3 or 103	4xxxx	0x0100	8	1 word	R/W	DI Counter Start
3 or 103	4xxxx	0x0120	8	1 word	R/W	DI Counter Clear
3 or 103	4xxxx	0x0250	5	1 word	R/W	AI Mode
3 or 103	4xxxx	0x0610	3	1 word	R/W	RTD Sensor Type

0xxxx Read/Write Coils (Support function 1, 5, 15)

Reference	Address	Data Type	Description
DO Channel			
00001	0x0000	1 bit	CH0 DO Value 0: Off 1: On
00002	0x0001	1 bit	CH1 DO Value 0: Off 1: On
00003	0x0002	1 bit	CH2 DO Value 0: Off 1: On
00004	0x0003	1 bit	CH3 DO Value 0: Off 1: On
00005	0x0004	1 bit	CH4 DO Value 0: Off 1: On
00006	0x0005	1 bit	CH5 DO Value 0: Off 1: On
00007	0x0006	1 bit	CH6 DO Value 0: Off 1: On
00008	0x0007	1 bit	CH7 DO Value 0: Off 1: On
00009	0x0008	1 bit	CH8 DO Value 0: Off 1: On
00010	0x0009	1 bit	CH9 DO Value 0: Off 1: On
00011	0x000A	1 bit	CH10 DO Value 0: Off 1: On
00012	0x000B	1 bit	CH11 DO Value 0: Off 1: On
00033	0x0020	1 bit	CH0 DO Pulse Operate Status 0: Off 1: On
00034	0x0021	1 bit	CH1 DO Pulse Operate Status 0: Off 1: On
00035	0x0022	1 bit	CH2 DO Pulse Operate Status 0: Off 1: On
00036	0x0023	1 bit	CH3 DO Pulse Operate Status 0: Off 1: On

Reference	Address	Data Type	Description
00037	0x0024	1 bit	CH4 DO Pulse Operate Status 0: Off 1: On
00038	0x0025	1 bit	CH5 DO Pulse Operate Status 0: Off 1: On
00039	0x0026	1 bit	CH6 DO Pulse Operate Status 0: Off 1: On
00040	0x0027	1 bit	CH7 DO Pulse Operate Status 0: Off 1: On
DI Channel			
00257	0x0100	1 bit	CH0 DI Counter Operate Status 0: Stop 1: Start(R/W)
00258	0x0101	1 bit	CH1 DI Counter Operate Status 0: Stop 1: Start(R/W)
00259	0x0102	1 bit	CH2 DI Counter Operate Status 0: Stop 1: Start(R/W)
00260	0x0103	1 bit	CH3 DI Counter Operate Status 0: Stop 1: Start(R/W)
00261	0x0104	1 bit	CH4 DI Counter Operate Status 0: Stop 1: Start(R/W)
00262	0x0105	1 bit	CH5 DI Counter Operate Status 0: Stop 1: Start(R/W)
00263	0x0106	1 bit	CH6 DI Counter Operate Status 0: Stop 1: Start(R/W)
00264	0x0107	1 bit	CH7 DI Counter Operate Status 0: Stop 1: Start(R/W)
00289	0x0120	1 bit	CH0 DI Clear Count Value Read Always return:0 Write: 1 : Clear counter value 0 : Return illegal data value(0x03)
00290	0x0121	1 bit	CH1 DI Clear Count Value Read Always return:0 Write: 1 : Clear counter value 0 : Return illegal data value(0x03)
00291	0x0122	1 bit	CH2 DI Clear Count Value Read Always return:0 Write: 1 : Clear counter value 0 : Return illegal data value(0x03)
00292	0x0123	1 bit	CH3 DI Clear Count Value Read Always return:0 Write: 1 : Clear counter value 0 : Return illegal data value(0x03)
00293	0x0124	1 bit	CH4 DI Clear Count Value Read Always return:0 Write: 1 : Clear counter value 0 : Return illegal data value(0x03)
00294	0x0125	1 bit	CH5 DI Clear Count Value Read Always return:0 Write: 1 : Clear counter value 0 : Return illegal data value(0x03)
00295	0x0126	1 bit	CH6 DI Clear Count Value Read Always return:0 Write: 1 : Clear counter value 0 : Return illegal data value(0x03)
00296	0x0127	1 bit	CH7 DI Clear Count Value Read Always return:0 Write: 1 : Clear counter value 0 : Return illegal data value(0x03)
00769	0x0300	1 bit	DIO0 1: output DO mode 0: input DI mode
00770	0x0301	1 bit	DIO1 1: output DO mode 0: input DI mode

Reference	Address	Data Type	Description
00771	0x0302	1 bit	DIO2 1: output DO mode 0: input DI mode
00772	0x0303	1 bit	DIO3 1: output DO mode 0: input DI mode
00773	0x0304	1 bit	DIO4 1: output DO mode 0: input DI mode
00774	0x0305	1 bit	DIO5 1: output DO mode 0: input DI mode
00775	0x0306	1 bit	DIO6 1: output DO mode 0: input DI mode
00776	0x0307	1 bit	DIO7 1: output DO mode 0: input DI mode
00777	0x0308	1 bit	DIO8 1: output DO mode 0: input DI mode
00778	0x0309	1 bit	DIO9 1: output DO mode 0: input DI mode
00779	0x030A	1 bit	DIO10 1: output DO mode 0: input DI mode
00780	0x030B	1 bit	DIO11 1: output DO mode 0: input DI mode

1xxxx Read only Coils (Support function 2)

Reference	Address	Data Type	Description
DI Channel			
10001	0x0000	1 bit	CH0 DI Value, 0=OFF, 1=ON (Read only)
10002	0x0001	1 bit	CH1 DI Value, 0=OFF, 1=ON (Read only)
10003	0x0002	1 bit	CH2 DI Value, 0=OFF, 1=ON (Read only)
10004	0x0003	1 bit	CH3 DI Value, 0=OFF, 1=ON (Read only)
10005	0x0004	1 bit	CH4 DI Value, 0=OFF, 1=ON (Read only)
10006	0x0005	1 bit	CH5 DI Value, 0=OFF, 1=ON (Read only)
10007	0x0006	1 bit	CH6 DI Value, 0=OFF, 1=ON (Read only)
10008	0x0007	1 bit	CH7 DI Value, 0=OFF, 1=ON (Read only)
10009	0x0008	1 bit	CH8 DI Value, 0=OFF, 1=ON (Read only)
10010	0x0009	1 bit	CH9 DI Value, 0=OFF, 1=ON (Read only)
10011	0x000A	1 bit	CH10 DI Value, 0=OFF, 1=ON (Read only)
10012	0x000B	1 bit	CH11 DI Value, 0=OFF, 1=ON (Read only)

3xxxx Read only Registers (Support function 4)

Reference	Address	Data Type	Description
DI Channel			
30001	0x0000	1 word	CH0 DI WordValue, 0=OFF, 1=ON (Read only)
30002	0x0001	1 word	CH1 DI WordValue, 0=OFF, 1=ON (Read only)
30003	0x0002	1 word	CH2 DI WordValue, 0=OFF, 1=ON (Read only)
30004	0x0003	1 word	CH3 DI WordValue, 0=OFF, 1=ON (Read only)
30005	0x0004	1 word	CH4 DI WordValue, 0=OFF, 1=ON (Read only)
30006	0x0005	1 word	CH5 DI WordValue, 0=OFF, 1=ON (Read only)
30007	0x0006	1 word	CH6 DI WordValue, 0=OFF, 1=ON (Read only)
30008	0x0007	1 word	CH7 DI WordValue, 0=OFF, 1=ON (Read only)
30009	0x0008	1 word	CH8 DI WordValue, 0=OFF, 1=ON (Read only)
30010	0x0009	1 word	CH9 DI WordValue, 0=OFF, 1=ON (Read only)
30011	0x000A	1 word	CH10 DI WordValue, 0=OFF, 1=ON (Read only)
30012	0x000B	1 word	CH11 DI WordValue, 0=OFF, 1=ON (Read only)
30033	0x0020	1 word	CH0 DI Counter Value Hi- Word (Read only)
30034	0x0021	1 word	CH0 DI Counter Value Lo- Word (Read only)
30035	0x0022	1 word	CH1 DI Counter Value Hi- Word (Read only)
30036	0x0023	1 word	CH1 DI Counter Value Lo- Word (Read only)
30037	0x0024	1 word	CH2 DI Counter Value Hi- Word (Read only)
30038	0x0025	1 word	CH2 DI Counter Value Lo- Word (Read only)
30039	0x0026	1 word	CH3 DI Counter Value Hi- Word (Read only)
30040	0x0027	1 word	CH3 DI Counter Value Lo- Word (Read only)
30041	0x0028	1 word	CH4 DI Counter Value Hi- Word (Read only)
30042	0x0029	1 word	CH4 DI Counter Value Lo- Word (Read only)
30043	0x002A	1 word	CH5 DI Counter Value Hi- Word (Read only)
30044	0x002B	1 word	CH5 DI Counter Value Lo- Word (Read only)
30045	0x002C	1 word	CH6 DI Counter Value Hi- Word (Read only)
30046	0x002D	1 word	CH6 DI Counter Value Lo- Word (Read only)
30047	0x002E	1 word	CH7 DI Counter Value Hi- Word (Read only)
30048	0x002F	1 word	CH7 DI Counter Value Lo- Word (Read only)
30065	0x0040	1 word	DI Value (Ch0~15) Bit0 = Ch0 DI Value (0=OFF, 1=ON) ...Bit15 = Ch15 DI Value (0=OFF, 1=ON)
AI Channel			
30513	0x0200	1 word	CH0 Read AI Value(RAW)
30514	0x0201	1 word	CH1 Read AI Value(RAW)
30515	0x0202	1 word	CH2 Read AI Value(RAW)
30516	0x0203	1 word	CH3 Read AI Value(RAW)
30517	0x0204	1 word	CH4 Read AI Value(RAW)
30529	0x0210	1 word	CH0 Read AI Scaling Value Hi (float)
30530	0x0211	1 word	CH0 Read AI Scaling Value Low (float)
30531	0x0212	1 word	CH1 Read AI Scaling Value Hi (float)
30532	0x0213	1 word	CH1 Read AI Scaling Value Low (float)
30533	0x0214	1 word	CH2 Read AI Scaling Value Hi (float)
30534	0x0215	1 word	CH2 Read AI Scaling Value Low (float)
30535	0x0216	1 word	CH3 Read AI Scaling Value Hi (float)
30536	0x0217	1 word	CH3 Read AI Scaling Value Low (float)
30537	0x0218	1 word	CH4 Read AI Scaling Value Hi (float)
30538	0x0219	1 word	CH4 Read AI Scaling Value Low (float)
30561	0x0230	1 word	Read AI 1 Current Mode Status

Reference	Address	Data Type	Description
			0: Normal 1: Burn Out 2: Over Range
30562	0x0231	1 word	Read AI 1 Current Mode Status 0: Normal 1: Burn Out 2: Over Range
30563	0x0232	1 word	Read AI 2 Current Mode Status 0: Normal 1: Burn Out 2: Over Range
30564	0x0233	1 word	Read AI 3 Current Mode Status 0: Normal 1: Burn Out 2: Over Range
30565	0x0234	1 word	Read AI 4 Current Mode Status 0: Normal 1: Burn Out 2: Over Range
RTD Channel			
31537	0x0600	1 word	CH0 RTD Value <R> 0~65535, Unit:0.1 (Ohm, Celsius, Fahrenheit)
31538	0x0601	1 word	CH1 RTD Value <R> 0~65535, Unit:0.1 (Ohm, Celsius, Fahrenheit)
31539	0x0602	1 word	CH2 RTD Value <R> 0~65535, Unit:0.1 (Ohm, Celsius, Fahrenheit)

4xxxx Read/Write Registers (Support function 3, 6, 16)

Reference	Address	Data Type	Description
DO Channel			
40001	0x0000	1 word	CH0 DO Value 0: Off 1: On
40002	0x0001	1 word	CH1 DO Value 0: Off 1: On
40003	0x0002	1 word	CH2 DO Value 0: Off 1: On
40004	0x0003	1 word	CH3 DO Value 0: Off 1: On
40005	0x0004	1 word	CH4 DO Value 0: Off 1: On
40006	0x0005	1 word	CH5 DO Value 0: Off 1: On
40007	0x0006	1 word	CH6 DO Value 0: Off 1: On
40008	0x0007	1 word	CH7 DO Value 0: Off 1: On
40009	0x0008	1 word	CH8 DO Value 0: Off 1: On
40010	0x0009	1 word	CH9 DO Value 0: Off 1: On
40011	0x000A	1 word	CH10 DO Value 0: Off 1: On
40012	0x000B	1 word	CH11 DO Value 0: Off 1: On
40033	0x0020	1 word	CH0 DO Pulse Operate Status 0: Off 1: On
40034	0x0021	1 word	CH1 DO Pulse Operate Status 0: Off 1: On
40035	0x0022	1 word	CH2 DO Pulse Operate Status 0: Off 1: On
40036	0x0023	1 word	CH3 DO Pulse Operate Status 0: Off 1: On
40037	0x0024	1 word	CH4 DO Pulse Operate Status 0: Off 1: On
40038	0x0025	1 word	CH5 DO Pulse Operate Status 0: Off 1: On
40039	0x0026	1 word	CH6 DO Pulse Operate Status 0: Off 1: On
40040	0x0027	1 word	CH7 DO Pulse Operate Status 0: Off 1: On
40065	0x0040	1 word	DO all Value (Ch0~15)

Reference	Address	Data Type	Description
			Bit0 = Ch0 DO Value (0=OFF, 1=ON) ... Bit15 = Ch15 DO Value (0=OFF, 1=ON)
DI Channel			
40257	0x0100	1 word	CH0 DI Counter Operate Status 0: Stop 1: Start(R/W)
40258	0x0101	1 word	CH1 DI Counter Operate Status 0: Stop 1: Start(R/W)
40259	0x0102	1 word	CH2 DI Counter Operate Status 0: Stop 1: Start(R/W)
40260	0x0103	1 word	CH3 DI Counter Operate Status 0: Stop 1: Start(R/W)
40261	0x0104	1 word	CH4 DI Counter Operate Status 0: Stop 1: Start(R/W)
40262	0x0105	1 word	CH5 DI Counter Operate Status 0: Stop 1: Start(R/W)
40263	0x0106	1 word	CH6 DI Counter Operate Status 0: Stop 1: Start(R/W)
40264	0x0107	1 word	CH7 DI Counter Operate Status 0: Stop 1: Start(R/W)
40289	0x0120	1 word	CH0 DI Clear Count Value Read Always return:0 Write: 1 : Clear counter value 0 : Return illegal data value(0x03)
40290	0x0121	1 word	CH1 DI Clear Count Value Read Always return:0 Write: 1 : Clear counter value 0 : Return illegal data value(0x03)
40291	0x0122	1 word	CH2 DI Clear Count Value Read Always return:0 Write: 1 : Clear counter value 0 : Return illegal data value(0x03)
40292	0x0123	1 word	CH3 DI Clear Count Value Read Always return:0 Write: 1 : Clear counter value 0 : Return illegal data value(0x03)
40293	0x0124	1 word	CH4 DI Clear Count Value Read Always return:0 Write: 1 : Clear counter value 0 : Return illegal data value(0x03)
40294	0x0125	1 word	CH5 DI Clear Count Value Read Always return:0 Write: 1 : Clear counter value 0 : Return illegal data value(0x03)
40295	0x0126	1 word	CH6 DI Clear Count Value Read Always return:0 Write: 1 : Clear counter value 0 : Return illegal data value(0x03)
40296	0x0127	1 word	CH7 DI Clear Count Value Read Always return:0 Write: 1 : Clear counter value 0 : Return illegal data value(0x03)
AI Channel			
40593	0x0250	1 bit	CH0 AI 0 Mode: 0 : 0-10V, 2 : 4-20mA(Bout), 3 : 0-20mA
40594	0x0251	1 bit	CH0 AI 1 Mode: 0 : 0-10V, 2 : 4-20mA(Bout), 3 : 0-20mA
40595	0x0252	1 bit	CH0 AI 2 Mode: 0 : 0-10V, 2 : 4-20mA(Bout), 3 : 0-20mA
40596	0x0253	1 bit	CH0 AI 3 Mode: 0 : 0-10V, 2 : 4-20mA(Bout), 3 : 0-20mA
40597	0x0254	1 bit	CH0 AI 4 Mode: 0 : 0-10V, 2 : 4-20mA(Bout), 3 : 0-20mA
41553	0x0610	1 word	CH0 RTD Sensor Type 1=PT100, 4=PT1000
41554	0x0611	1 word	CH1 RTD Sensor Type

Reference	Address	Data Type	Description
			1=PT100, 4=PT1000
41555	0x0612	1 word	CH2 RTD Sensor Type 1=PT100, 4=PT1000

E1263H Modbus Mapping

Fixed + Dynamic Default addresses

Func Code	Reference	Address	Channel	Data Type	R/W	Description
1 or 101	0xxxx	0x0000	24	1 bit	R/W	DO Value
1 or 101	0xxxx	0x0020	8	1 bit	R/W	DO Pulse Operate Status
1 or 101	0xxxx	0x0100	8	1 bit	R/W	DI Counter Start
1 or 101	0xxxx	0x0120	8	1 bit	R/W	DI Counter Clear
1 or 101	0xxxx	0x0300	24	1 bit	R/W	DIO Direction (DIO0-DIO23)
2 or 102	1xxxx	0x0000	24	1 bit	R	Get DI Value
4 or 104	3xxxx	0x0000	24	1 word	R	Get DI WordValue
4 or 104	3xxxx	0x0020	8	2 word	R	Get DI Counter Value Hi&Low Word
4 or 104	3xxxx	0x0040	NA	2 word	R	GET DI Value all Channel (Ch0~23)
4 or 104	3xxxx	0x0200	10	1 word	R	Read AI Value (Raw data)
4 or 104	3xxxx	0x0210	10	2 word	R	Read AI Value Scaling (float)
4 or 104	3xxxx	0x0230	10	1 word	R	Read AI current Mode Status
4 or 104	3xxxx	0x0600	3	1 word	R	RTD Value
3 or 103	4xxxx	0x0000	24	1 word	R/W	DO Value
3 or 103	4xxxx	0x0020	8	1 word	R/W	DO Pulse Operate Status
3 or 103	4xxxx	0x0040	NA	2 word	R/W	DO WordValue (Ch0-23)
3 or 103	4xxxx	0x0100	8	1 word	R/W	DI Counter Start
3 or 103	4xxxx	0x0120	8	1 word	R/W	DI Counter Clear
3 or 103	4xxxx	0x0250	10	1 word	R/W	AI Mode
3 or 103	4xxxx	0x0610	3	1 word	R/W	RTD Sensor Type

0xxxx Read/Write Coils (Support function 1, 5, 15)

Reference	Address	Data Type	Description
DO Channel			
00001	0x0000	1 bit	CH0 DO Value 0: Off 1: On
00002	0x0001	1 bit	CH1 DO Value 0: Off 1: On
00003	0x0002	1 bit	CH2 DO Value 0: Off 1: On
00004	0x0003	1 bit	CH3 DO Value 0: Off 1: On
00005	0x0004	1 bit	CH4 DO Value 0: Off 1: On
00006	0x0005	1 bit	CH5 DO Value 0: Off 1: On
00007	0x0006	1 bit	CH6 DO Value 0: Off 1: On
00008	0x0007	1 bit	CH7 DO Value 0: Off 1: On
00009	0x0008	1 bit	CH8 DO Value 0: Off 1: On
00010	0x0009	1 bit	CH9 DO Value 0: Off 1: On
00011	0x000A	1 bit	CH10 DO Value 0: Off 1: On
00012	0x000B	1 bit	CH11 DO Value 0: Off 1: On
00013	0x000C	1 bit	CH12 DO Value 0: Off 1: On
00014	0x000D	1 bit	CH13 DO Value 0: Off 1: On
00015	0x000E	1 bit	CH14 DO Value 0: Off 1: On

Reference	Address	Data Type	Description
00016	0x000F	1 bit	CH15 DO Value 0: Off 1: On
00017	0x0010	1 bit	CH16 DO Value 0: Off 1: On
00018	0x0011	1 bit	CH17 DO Value 0: Off 1: On
00019	0x0012	1 bit	CH18 DO Value 0: Off 1: On
00020	0x0013	1 bit	CH19 DO Value 0: Off 1: On
00021	0x0014	1 bit	CH20 DO Value 0: Off 1: On
00022	0x0015	1 bit	CH21 DO Value 0: Off 1: On
00023	0x0016	1 bit	CH22 DO Value 0: Off 1: On
00024	0x0017	1 bit	CH23 DO Value 0: Off 1: On
00033	0x0020	1 bit	CH0 DO Pulse Operate Status 0: Off 1: On
00034	0x0021	1 bit	CH1 DO Pulse Operate Status 0: Off 1: On
00035	0x0022	1 bit	CH2 DO Pulse Operate Status 0: Off 1: On
00036	0x0023	1 bit	CH3 DO Pulse Operate Status 0: Off 1: On
00037	0x0024	1 bit	CH4 DO Pulse Operate Status 0: Off 1: On
00038	0x0025	1 bit	CH5 DO Pulse Operate Status 0: Off 1: On
00039	0x0026	1 bit	CH6 DO Pulse Operate Status 0: Off 1: On
00040	0x0027	1 bit	CH7 DO Pulse Operate Status 0: Off 1: On
DI Channel			
00257	0x0100	1 bit	CH0 DI Counter Operate Status 0: Stop 1: Start(R/W)
00258	0x0101	1 bit	CH1 DI Counter Operate Status 0: Stop 1: Start(R/W)
00259	0x0102	1 bit	CH2 DI Counter Operate Status 0: Stop 1: Start(R/W)
00260	0x0103	1 bit	CH3 DI Counter Operate Status 0: Stop 1: Start(R/W)
00261	0x0104	1 bit	CH4 DI Counter Operate Status 0: Stop 1: Start(R/W)
00262	0x0105	1 bit	CH5 DI Counter Operate Status 0: Stop 1: Start(R/W)
00263	0x0106	1 bit	CH6 DI Counter Operate Status 0: Stop 1: Start(R/W)
00264	0x0107	1 bit	CH7 DI Counter Operate Status 0: Stop 1: Start(R/W)
00289	0x0120	1 bit	CH0 DI Clear Count Value Read Always return:0 Write: 1 : Clear counter value 0 : Return illegal data value(0x03)
00290	0x0121	1 bit	CH1 DI Clear Count Value Read Always return:0 Write: 1 : Clear counter value 0 : Return illegal data value(0x03)
00291	0x0122	1 bit	CH2 DI Clear Count Value Read Always return:0 Write: 1 : Clear counter value 0 : Return illegal data value(0x03)
00292	0x0123	1 bit	CH3 DI Clear Count Value Read Always return:0 Write: 1 : Clear counter value 0 : Return illegal data value(0x03)
00293	0x0124	1 bit	CH4 DI Clear Count Value Read Always return:0 Write: 1 : Clear counter value 0 : Return illegal data value(0x03)
00294	0x0125	1 bit	CH5 DI Clear Count Value Read Always return:0 Write: 1 : Clear counter value 0 : Return illegal data value(0x03)

Reference	Address	Data Type	Description
00295	0x0126	1 bit	CH6 DI Clear Count Value Read Always return:0 Write: 1 : Clear counter value 0 : Return illegal data value(0x03)
00296	0x0127	1 bit	CH7 DI Clear Count Value Read Always return:0 Write: 1 : Clear counter value 0 : Return illegal data value(0x03)
00769	0x0300	1 bit	DIO0 1: output DO mode 0: input DI mode
00770	0x0301	1 bit	DIO1 1: output DO mode 0: input DI mode
00771	0x0302	1 bit	DIO2 1: output DO mode 0: input DI mode
00772	0x0303	1 bit	DIO3 1: output DO mode 0: input DI mode
00773	0x0304	1 bit	DIO4 1: output DO mode 0: input DI mode
00774	0x0305	1 bit	DIO5 1: output DO mode 0: input DI mode
00775	0x0306	1 bit	DIO6 1: output DO mode 0: input DI mode
00776	0x0307	1 bit	DIO7 1: output DO mode 0: input DI mode
00777	0x0308	1 bit	DIO8 1: output DO mode 0: input DI mode
00778	0x0309	1 bit	DIO9 1: output DO mode 0: input DI mode
00779	0x030A	1 bit	DIO10 1: output DO mode 0: input DI mode
00780	0x030B	1 bit	DIO11 1: output DO mode 0: input DI mode
00781	0x030C	1 bit	DIO12 1: output DO mode 0: input DI mode
00782	0x030D	1 bit	DIO13 1: output DO mode 0: input DI mode
00783	0x030E	1 bit	DIO14 1: output DO mode 0: input DI mode

Reference	Address	Data Type	Description
00784	0x030F	1 bit	DIO15 1: output DO mode 0: input DI mode
00785	0x0310	1 bit	DIO16 1: output DO mode 0: input DI mode
00786	0x0311	1 bit	DIO17 1: output DO mode 0: input DI mode
00787	0x0312	1 bit	DIO18 1: output DO mode 0: input DI mode
00788	0x0313	1 bit	DIO19 1: output DO mode 0: input DI mode
00789	0x0314	1 bit	DIO20 1: output DO mode 0: input DI mode
00790	0x0315	1 bit	DIO21 1: output DO mode 0: input DI mode
00791	0x0316	1 bit	DIO22 1: output DO mode 0: input DI mode
00792	0x0317	1 bit	DIO23 1: output DO mode 0: input DI mode

1xxxx Read only Coils (Support function 2)

Reference	Address	Data Type	Description
DI Channel			
10001	0x0000	1 bit	CH0 DI Value, 0=OFF, 1=ON (Read only)
10002	0x0001	1 bit	CH1 DI Value, 0=OFF, 1=ON (Read only)
10003	0x0002	1 bit	CH2 DI Value, 0=OFF, 1=ON (Read only)
10004	0x0003	1 bit	CH3 DI Value, 0=OFF, 1=ON (Read only)
10005	0x0004	1 bit	CH4 DI Value, 0=OFF, 1=ON (Read only)
10006	0x0005	1 bit	CH5 DI Value, 0=OFF, 1=ON (Read only)
10007	0x0006	1 bit	CH6 DI Value, 0=OFF, 1=ON (Read only)
10008	0x0007	1 bit	CH7 DI Value, 0=OFF, 1=ON (Read only)
10009	0x0008	1 bit	CH8 DI Value, 0=OFF, 1=ON (Read only)
10010	0x0009	1 bit	CH9 DI Value, 0=OFF, 1=ON (Read only)
10011	0x000A	1 bit	CH10 DI Value, 0=OFF, 1=ON (Read only)
10012	0x000B	1 bit	CH11 DI Value, 0=OFF, 1=ON (Read only)
10013	0x000C	1 bit	CH12 DI Value, 0=OFF, 1=ON (Read only)
10014	0x000D	1 bit	CH13 DI Value, 0=OFF, 1=ON (Read only)
10015	0x000E	1 bit	CH14 DI Value, 0=OFF, 1=ON (Read only)
10016	0x000F	1 bit	CH15 DI Value, 0=OFF, 1=ON (Read only)
10017	0x0010	1 bit	CH16 DI Value, 0=OFF, 1=ON (Read only)
10018	0x0011	1 bit	CH17 DI Value, 0=OFF, 1=ON (Read only)
10019	0x0012	1 bit	CH18 DI Value, 0=OFF, 1=ON (Read only)
10020	0x0013	1 bit	CH19 DI Value, 0=OFF, 1=ON (Read only)

Reference	Address	Data Type	Description
10021	0x0014	1 bit	CH20 DI Value, 0=OFF, 1=ON (Read only)
10022	0x0015	1 bit	CH21 DI Value, 0=OFF, 1=ON (Read only)
10023	0x0016	1 bit	CH22 DI Value, 0=OFF, 1=ON (Read only)
10024	0x0017	1 bit	CH23 DI Value, 0=OFF, 1=ON (Read only)

3xxxx Read Registers (Support function 4)

Reference	Address	Data Type	Description
DI Channel			
30001	0x0000	1 word	CH0 DI WordValue, 0=OFF, 1=ON (Read only)
30002	0x0001	1 word	CH1 DI WordValue, 0=OFF, 1=ON (Read only)
30003	0x0002	1 word	CH2 DI WordValue, 0=OFF, 1=ON (Read only)
30004	0x0003	1 word	CH3 DI WordValue, 0=OFF, 1=ON (Read only)
30005	0x0004	1 word	CH4 DI WordValue, 0=OFF, 1=ON (Read only)
30006	0x0005	1 word	CH5 DI WordValue, 0=OFF, 1=ON (Read only)
30007	0x0006	1 word	CH6 DI WordValue, 0=OFF, 1=ON (Read only)
30008	0x0007	1 word	CH7 DI WordValue, 0=OFF, 1=ON (Read only)
30009	0x0008	1 word	CH8 DI WordValue, 0=OFF, 1=ON (Read only)
30010	0x0009	1 word	CH9 DI WordValue, 0=OFF, 1=ON (Read only)
30011	0x000A	1 word	CH10 DI WordValue, 0=OFF, 1=ON (Read only)
30012	0x000B	1 word	CH11 DI WordValue, 0=OFF, 1=ON (Read only)
30013	0x000C	1 word	CH12 DI WordValue, 0=OFF, 1=ON (Read only)
30014	0x000D	1 word	CH13 DI WordValue, 0=OFF, 1=ON (Read only)
30015	0x000E	1 word	CH14 DI WordValue, 0=OFF, 1=ON (Read only)
30016	0x000F	1 word	CH15 DI WordValue, 0=OFF, 1=ON (Read only)
30017	0x0010	1 word	CH16 DI WordValue, 0=OFF, 1=ON (Read only)
30018	0x0011	1 word	CH17 DI WordValue, 0=OFF, 1=ON (Read only)
30019	0x0012	1 word	CH18 DI WordValue, 0=OFF, 1=ON (Read only)
30020	0x0013	1 word	CH19 DI WordValue, 0=OFF, 1=ON (Read only)
30021	0x0014	1 word	CH20 DI WordValue, 0=OFF, 1=ON (Read only)
30022	0x0015	1 word	CH21 DI WordValue, 0=OFF, 1=ON (Read only)
30023	0x0016	1 word	CH10 DI WordValue, 0=OFF, 1=ON (Read only)
30024	0x0017	1 word	CH11 DI WordValue, 0=OFF, 1=ON (Read only)
30033	0x0020	1 word	CH0 DI Counter Value Hi- Word (Read only)
30034	0x0021	1 word	CH0 DI Counter Value Lo- Word (Read only)
30035	0x0022	1 word	CH1 DI Counter Value Hi- Word (Read only)
30036	0x0023	1 word	CH1 DI Counter Value Lo- Word (Read only)
30037	0x0024	1 word	CH2 DI Counter Value Hi- Word (Read only)
30038	0x0025	1 word	CH2 DI Counter Value Lo- Word (Read only)
30039	0x0026	1 word	CH3 DI Counter Value Hi- Word (Read only)
30040	0x0027	1 word	CH3 DI Counter Value Lo- Word (Read only)
30041	0x0028	1 word	CH4 DI Counter Value Hi- Word (Read only)
30042	0x0029	1 word	CH4 DI Counter Value Lo- Word (Read only)
30043	0x002A	1 word	CH5 DI Counter Value Hi- Word (Read only)
30044	0x002B	1 word	CH5 DI Counter Value Lo- Word (Read only)
30045	0x002C	1 word	CH6 DI Counter Value Hi- Word (Read only)
30046	0x002D	1 word	CH6 DI Counter Value Lo- Word (Read only)
30047	0x002E	1 word	CH7 DI Counter Value Hi- Word (Read only)
30048	0x002F	1 word	CH7 DI Counter Value Lo- Word (Read only)

Reference	Address	Data Type	Description
30065	0x0040	1 word	DI Value (Ch0~15) Bit0 = Ch0 DI Value (0=OFF, 1=ON) Bit15 = Ch15 DI Value (0=OFF, 1=ON)
30066	0x0041	1 word	DI Value (Ch16~23) Bit0 = Ch16 DI Value (0=OFF, 1=ON) ... Bit7 = Ch23 DI Value (0=OFF, 1=ON)
AI Channel			
30513	0x0200	1 word	CH0 Read AI Value(RAW)
30514	0x0201	1 word	CH1 Read AI Value(RAW)
30515	0x0202	1 word	CH2 Read AI Value(RAW)
30516	0x0203	1 word	CH3 Read AI Value(RAW)
30517	0x0204	1 word	CH4 Read AI Value(RAW)
30518	0x0205	1 word	CH5 Read AI Value(RAW)
30519	0x0206	1 word	CH6 Read AI Value(RAW)
30520	0x0207	1 word	CH7 Read AI Value(RAW)
30521	0x0208	1 word	CH8 Read AI Value(RAW)
30522	0x0209	1 word	CH9 Read AI Value(RAW)
30529	0x0210	1 word	CH0 Read AI Scaling Value Hi (float)
30530	0x0211	1 word	CH0 Read AI Scaling Value Low (float)
30531	0x0212	1 word	CH1 Read AI Scaling Value Hi (float)
30532	0x0213	1 word	CH1 Read AI Scaling Value Low (float)
30533	0x0214	1 word	CH2 Read AI Scaling Value Hi (float)
30534	0x0215	1 word	CH2 Read AI Scaling Value Low (float)
30535	0x0216	1 word	CH3 Read AI Scaling Value Hi (float)
30536	0x0217	1 word	CH3 Read AI Scaling Value Low (float)
30537	0x0218	1 word	CH4 Read AI Scaling Value Hi (float)
30538	0x0219	1 word	CH4 Read AI Scaling Value Low (float)
30539	0x021A	1 word	CH5 Read AI Scaling Value Hi (float)
30540	0x021B	1 word	CH5 Read AI Scaling Value Low (float)
30541	0x021C	1 word	CH6 Read AI Scaling Value Hi (float)
30542	0x021D	1 word	CH6 Read AI Scaling Value Low (float)
30543	0x021E	1 word	CH7 Read AI Scaling Value Hi (float)
30544	0x021F	1 word	CH7 Read AI Scaling Value Low (float)
30545	0x0220	1 word	CH8 Read AI Scaling Value Hi (float)
30546	0x0221	1 word	CH8 Read AI Scaling Value Low (float)
30547	0x0222	1 word	CH9 Read AI Scaling Value Hi (float)
30548	0x0223	1 word	CH9 Read AI Scaling Value Low (float)
30561	0x0230	1 word	Read AI 1 Current Mode Status 0: Normal 1: Burn Out 2: Over Range
30562	0x0231	1 word	Read AI 1 Current Mode Status 0: Normal 1: Burn Out 2: Over Range
30563	0x0232	1 word	Read AI 2 Current Mode Status 0: Normal 1: Burn Out 2: Over Range

Reference	Address	Data Type	Description
30564	0x0233	1 word	Read AI 3 Current Mode Status 0: Normal 1: Burn Out 2: Over Range
30565	0x0234	1 word	Read AI 4 Current Mode Status 0: Normal 1: Burn Out 2: Over Range
30566	0x0235	1 word	Read AI 5 Current Mode Status 0: Normal 1: Burn Out 2: Over Range
30567	0x0236	1 word	Read AI 6 Current Mode Status 0: Normal 1: Burn Out 2: Over Range
30568	0x0237	1 word	Read AI 7 Current Mode Status 0: Normal 1: Burn Out 2: Over Range
30569	0x0238	1 word	Read AI 8 Current Mode Status 0: Normal 1: Burn Out 2: Over Range
30570	0x0239	1 word	Read AI 9 Current Mode Status 0: Normal 1: Burn Out 2: Over Range
RTD Channel			
31537	0x0600	1 word	CH0 RTD Value <R> 0~65535, Unit:0.1 (Ohm, Celsius, Fahrenheit)
31538	0x0601	1 word	CH1 RTD Value <R> 0~65535, Unit:0.1 (Ohm, Celsius, Fahrenheit)
31539	0x0602	1 word	CH2 RTD Value <R> 0~65535, Unit:0.1 (Ohm, Celsius, Fahrenheit)

4xxxx Read/Write Registers (Support function 3, 6, 16)

Reference	Address	Data Type	Description
DO Channel			
40001	0x0000	1 word	CH0 DO Value 0: Off 1: On
40002	0x0001	1 word	CH1 DO Value 0: Off 1: On
40003	0x0002	1 word	CH2 DO Value 0: Off 1: On
40004	0x0003	1 word	CH3 DO Value 0: Off 1: On
40005	0x0004	1 word	CH4 DO Value 0: Off 1: On
40006	0x0005	1 word	CH5 DO Value 0: Off 1: On
40007	0x0006	1 word	CH6 DO Value 0: Off 1: On
40008	0x0007	1 word	CH7 DO Value 0: Off 1: On
40009	0x0008	1 word	CH8 DO Value 0: Off 1: On
40010	0x0009	1 word	CH9 DO Value 0: Off 1: On
40011	0x000A	1 word	CH10 DO Value 0: Off 1: On
40012	0x000B	1 word	CH11 DO Value 0: Off 1: On

Reference	Address	Data Type	Description
40013	0x000C	1 word	CH12 DO Value 0: Off 1: On
40014	0x000D	1 word	CH13 DO Value 0: Off 1: On
40015	0x000E	1 word	CH14 DO Value 0: Off 1: On
40016	0x000F	1 word	CH15 DO Value 0: Off 1: On
40017	0x0010	1 word	CH16 DO Value 0: Off 1: On
40018	0x0011	1 word	CH17 DO Value 0: Off 1: On
40019	0x0012	1 word	CH18 DO Value 0: Off 1: On
40020	0x0013	1 word	CH19 DO Value 0: Off 1: On
40021	0x0014	1 word	CH20 DO Value 0: Off 1: On
40022	0x0015	1 word	CH21 DO Value 0: Off 1: On
40023	0x0016	1 word	CH22 DO Value 0: Off 1: On
40024	0x0017	1 word	CH23 DO Value 0: Off 1: On
40033	0x0020	1 word	CH0 DO Pulse Operate Status 0: Off 1: On
40034	0x0021	1 word	CH1 DO Pulse Operate Status 0: Off 1: On
40035	0x0022	1 word	CH2 DO Pulse Operate Status 0: Off 1: On
40036	0x0023	1 word	CH3 DO Pulse Operate Status 0: Off 1: On
40037	0x0024	1 word	CH4 DO Pulse Operate Status 0: Off 1: On
40038	0x0025	1 word	CH5 DO Pulse Operate Status 0: Off 1: On
40039	0x0026	1 word	CH6 DO Pulse Operate Status 0: Off 1: On
40040	0x0027	1 word	CH7 DO Pulse Operate Status 0: Off 1: On
40065	0x0040	1 word	DO all Value (Ch0~15) Bit0 = Ch0 DO Value (0=OFF, 1=ON) ... Bit15 = Ch15 DO Value (0=OFF, 1=ON)
40066	0x0041	1 word	DO all Value (Ch16~23) Bit0 = Ch16 DO Value (0=OFF, 1=ON) ... Bit7 = Ch23 DO Value (0=OFF, 1=ON)
DI Channel			
40257	0x0100	1 word	CH0 DI Counter Operate Status 0: Stop 1: Start(R/W)
40258	0x0101	1 word	CH1 DI Counter Operate Status 0: Stop 1: Start(R/W)
40259	0x0102	1 word	CH2 DI Counter Operate Status 0: Stop 1: Start(R/W)
40260	0x0103	1 word	CH3 DI Counter Operate Status 0: Stop 1: Start(R/W)
40261	0x0104	1 word	CH4 DI Counter Operate Status 0: Stop 1: Start(R/W)
40262	0x0105	1 word	CH5 DI Counter Operate Status 0: Stop 1: Start(R/W)
40263	0x0106	1 word	CH6 DI Counter Operate Status 0: Stop 1: Start(R/W)
40264	0x0107	1 word	CH7 DI Counter Operate Status 0: Stop 1: Start(R/W)
40289	0x0120	1 word	CH0 DI Clear Count Value Read Always return:0 Write: 1 : Clear counter value 0 : Return illegal data value(0x03)
40290	0x0121	1 word	CH1 DI Clear Count Value Read Always return:0 Write: 1 : Clear counter value 0 : Return illegal data value(0x03)
40291	0x0122	1 word	CH2 DI Clear Count Value Read Always return:0 Write: 1 : Clear counter value 0 : Return illegal data value(0x03)
40292	0x0123	1 word	CH3 DI Clear Count Value Read Always return:0 Write: 1 : Clear counter value

Reference	Address	Data Type	Description
			0 : Return illegal data value(0x03)
40293	0x0124	1 word	CH4 DI Clear Count Value Read Always return:0 Write: 1 : Clear counter value 0 : Return illegal data value(0x03)
40294	0x0125	1 word	CH5 DI Clear Count Value Read Always return:0 Write: 1 : Clear counter value 0 : Return illegal data value(0x03)
40295	0x0126	1 word	CH6 DI Clear Count Value Read Always return:0 Write: 1 : Clear counter value 0 : Return illegal data value(0x03)
40296	0x0127	1 word	CH7 DI Clear Count Value Read Always return:0 Write: 1 : Clear counter value 0 : Return illegal data value(0x03)
AI Channel			
40593	0x0250	1 bit	CH0 AI 0 Mode: 0 : 0-10V, 2 : 4-20mA(Bout), 3 : 0-20mA
40594	0x0251	1 bit	CH0 AI 1 Mode: 0 : 0-10V, 2 : 4-20mA(Bout), 3 : 0-20mA
40595	0x0252	1 bit	CH0 AI 2 Mode: 0 : 0-10V, 2 : 4-20mA(Bout), 3 : 0-20mA
40596	0x0253	1 bit	CH0 AI 3 Mode: 0 : 0-10V, 2 : 4-20mA(Bout), 3 : 0-20mA
40597	0x0254	1 bit	CH0 AI 4 Mode: 0 : 0-10V, 2 : 4-20mA(Bout), 3 : 0-20mA
40598	0x0255	1 bit	CH0 AI 5 Mode: 0 : 0-10V, 2 : 4-20mA(Bout), 3 : 0-20mA
40599	0x0256	1 bit	CH0 AI 6 Mode: 0 : 0-10V, 2 : 4-20mA(Bout), 3 : 0-20mA
40600	0x0257	1 bit	CH0 AI 7 Mode: 0 : 0-10V, 2 : 4-20mA(Bout), 3 : 0-20mA
40601	0x0258	1 bit	CH0 AI 8 Mode: 0 : 0-10V, 2 : 4-20mA(Bout), 3 : 0-20mA
40602	0x0259	1 bit	CH0 AI 9 Mode: 0 : 0-10V, 2 : 4-20mA(Bout), 3 : 0-20mA
41553	0x0610	1 word	CH0 RTD Sensor Type 1=PT100, 4=PT1000
41554	0x0611	1 word	CH1 RTD Sensor Type 1=PT100, 4=PT1000
41555	0x0612	1 word	CH2 RTD Sensor Type 1=PT100, 4=PT1000

B

Network Port Numbers

ioLogik E1200H Network Port Usage

Port	Type	Usage
80	TCP	Web console service
502	TCP	Modbus/TCP communication
68	UDP	BOOTP/DHCP
4800	UDP	Auto search
69	UDP	Export/import configuration file
9900	TCP	Active OPC Server
9500	TCP	Active OPC Server

Factory Defaults

ioLogik E1200H series products are configured with the following factory defaults:

Default IP address	192.168.127.254
Default Netmask	255.255.255.0
Default Gateway	0.0.0.0
Communication watchdog	Disable
Modbus/TCP Alive Check	On
Modbus/TCP Timeout Interval	60 sec
DI Mode	DI
Filter time	100 ms
Trigger for counter	Lo to Hi
Counter status	Stop
DO Mode	DO
DO Safe Status	Disable
Power on status	Disable
Low width for pulse	1 ms (1.5 s for relay)
Hi width for pulse	1 ms (1.5 s for relay)
Output pulses	0 (continuous)
DIO Mode	DO
AI Mode	Voltage
Scaling and Slop-Intercept	Disable
Password	N/A
Server Name	N/A
Server Location	N/A
Scaling	Disable

D

Pinouts

Terminal Block Pin Assignments

ioLogik E1261H (Bottom)		ioLogik E1261H (TOP)		ioLogik E1263H (Bottom)		ioLogik E1263H (TOP)	
1	COM	1	EX0	1	EX0	1	COM0
2	DIO0	2	IN0 +	2	IN0 +	2	DIO0
3	DIO1	3	IN0 -	3	IN0 -	3	DIO1
4	DIO2	4	EX1	4	EX1	4	DIO2
5	DIO3	5	IN1 +	5	IN1 +	5	DIO3
6	GND	6	IN1 -	6	IN1 -	6	DIO4
7	DIO4	7	EX2	7	EX2	7	DIO5
8	DIO5	8	IN2 +	8	IN2 +	8	GND
9	DIO6	9	IN2 -	9	IN2 -	9	DIO6
10	DIO7	10	N.C.	10	N.C.	10	DIO7
11	GND	11	AI0 +	11	AI0 +	11	DIO8
12	DIO8	12	AI0 -	12	AI0 -	12	DIO9
13	DIO9	13	AI1 +	13	AI1 +	13	DIO10
14	DIO10	14	AI1 -	14	AI1 -	14	DIO11
16	DIO11	15	AI2 +	15	AI2 +	15	GND
17	GND	16	AI2 -	16	AI2 -	16	COM1
		17	AI3 +	17	AI3 +	14	DIO12
		18	AI3 -	18	AI3 -	18	DIO13
		19	AI4 +	19	AI4 +	19	DIO14
		20	AI4 -	19	AI4 -	20	DIO15
				20	AI5 +		
				21	AI5 -	21	DIO16
				22	AI6 +	22	DIO17
				23	AI6 -	23	GND
				24	AI7 +	24	DIO18
				25	AI7 -	25	DIO19
				26	AI8 +	26	DIO20
				27	AI8 -	27	DIO21
						28	DIO22
						29	DIO23
						30	GND
						31	AI9 +
						32	AI9 -

E

FCC Interference Statement

Federal Communication Commission Warning!

This equipment has been tested and found to comply with the limits for a Class A digital device, pursuant to part 15 of the FCC Rules. Operation is subject to the following two conditions: (1) This device may not cause harmful interference, and (2) this device must accept any interference received, including interference that may cause undesired operation.

These limits are designed to provide reasonable protection against harmful interference when the equipment is operated in a commercial environment. This equipment generates, uses, and can radiate radio frequency energy and, if not installed and used in accordance with the instruction manual, may cause harmful interference to radio communications. Operation of this equipment in a residential area is likely to cause harmful interference in which case the user will be required to correct the interference at his own expense.

F

European Community (CE)

This is a Class A product. In a domestic environment, this product may cause radio interference in which case the user may be required to take adequate measures.