

DA-661/662/663-LX User's Manual

Fourth Edition, February 2009

www.moxa.com/product

MOXA®

© 2009 Moxa Inc. All rights reserved.
Reproduction without permission is prohibited.

DA-661/662/663-LX

User's Manual

The software described in this manual is furnished under a license agreement and may be used only in accordance with the terms of that agreement.

Copyright Notice

Copyright © 2009 Moxa Inc.
All rights reserved.
Reproduction without permission is prohibited.

Trademarks

MOXA is a registered trademark of Moxa Inc.
All other trademarks or registered marks in this manual belong to their respective manufacturers.

Disclaimer

Information in this document is subject to change without notice and does not represent a commitment on the part of Moxa.

Moxa provides this document “as is,” without warranty of any kind, either expressed or implied, including, but not limited to, its particular purpose. Moxa reserves the right to make improvements and/or changes to this manual, or to the products and/or the programs described in this manual, at any time.

Information provided in this manual is intended to be accurate and reliable. However, Moxa assumes no responsibility for its use, or for any infringements on the rights of third parties that may result from its use.

This product might include unintentional technical or typographical errors. Changes are periodically made to the information herein to correct such errors, and these changes are incorporated into new editions of the publication.

Technical Support Contact Information

www.moxa.com/support

Moxa Americas:

Toll-free: 1-888-669-2872
Tel: +1-714-528-6777
Fax: +1-714-528-6778

Moxa Europe:

Tel: +49-89-3 70 03 99-0
Fax: +49-89-3 70 03 99-99

Moxa China (Shanghai office):

Toll-free: 800-820-5036
Tel: +86-21-5258-9955
Fax: +86-10-6872-3958

Moxa Asia-Pacific:

Tel: +886-2-8919-1230
Fax: +886-2-8919-1231

Table of Contents

Chapter 1	Introduction	1-1
	Overview.....	1-2
	Software Architecture	1-2
	Journaling Flash File System (JFFS2).....	1-3
	Software Package	1-4
Chapter 2	Getting Started	2-1
	Powering on the DA-661/662/663	2-2
	Connecting the DA-661/662/663 to a PC	2-2
	Serial Console.....	2-2
	Telnet Console.....	2-3
	SSH Console.....	2-4
	Configuring the Ethernet Interface	2-5
	Modifying Network Settings with the Serial Console	2-5
	Modifying Network Settings over the Network.....	2-6
	Configuring the WLAN via the PCMCIA Interface	2-7
	Test Program—Developing Hello.c	2-13
	Installing the Tool Chain (Linux)	2-13
	Checking the Flash Memory Space	2-14
	Compiling Hello.c	2-14
	Uploading and Running the “Hello” Program	2-15
	Developing Your First Application	2-15
	Testing Environment	2-15
	Compiling tcps2.c.....	2-16
	Uploading and Running the “tcps2-release” Program	2-17
	Testing Procedure Summary.....	2-19
Chapter 3	Managing Embedded Linux	3-1
	System Version Information.....	3-2
	System Image Backup.....	3-2
	Upgrading the Firmware.....	3-2
	Loading Factory Defaults	3-4
	Enabling and Disabling Daemons.....	3-4
	Setting the Run-level	3-6
	Adjusting the System Time	3-7
	Setting the Time Manually	3-7
	NTP Client.....	3-8
	Updating the Time Automatically	3-8
	Cron—Daemon for Executing Scheduled Commands.....	3-9
	Connecting Peripherals	3-9
	USB Mass Storage.....	3-9
	CF Mass Storage.....	3-10
Chapter 4	Managing Communications	4-1
	Telnet / FTP	4-2
	DNS	4-2
	Web Service—Apache	4-3
	IPTABLES	4-4
	NAT.....	4-8

	NAT Example.....	4-9
	Enabling NAT at Bootup.....	4-9
	Dial-up Service—PPP.....	4-10
	PPPoE.....	4-13
	NFS (Network File System).....	4-15
	Setting up the DA-661/662/663 as an NFS Server.....	4-15
	Setting up the DA-661/662/663 as an NFS Client.....	4-16
	Mail.....	4-17
	SNMP.....	4-17
	OpenVPN.....	4-18
Chapter 5	Programmer's Guide.....	5-1
	Flash Memory Map.....	5-2
	Linux Tool Chain Introduction.....	5-2
	Debugging with GDB.....	5-3
	Device API.....	5-4
	RTC (Real-time Clock).....	5-4
	Buzzer.....	5-4
	WDT (Watchdog Timer).....	5-5
	UART.....	5-8
	LCM.....	5-10
	KeyPad.....	5-10
	Make File Example.....	5-11
Appendix A	System Commands.....	A-1
	Linux normal command utility collection.....	A-1
	File Manager.....	A-1
	Editor.....	A-1
	Network.....	A-1
	Process.....	A-2
	Other.....	A-2
	Moxa Special Utilities.....	A-2
Appendix B	Using the Push Buttons to Operate the LCD Screen.....	B-1

The DA-661/662/663 is RISC-based, ready-to-run embedded computers designed for industrial data acquisition applications. Each model has 16 RS-232/422/485 serial ports, 1 CF socket, 1 PCMCIA socket, and 2 USB hosts based on the Intel XScale IXP-425 communication processor. In addition, the DA-661 has two Ethernet ports, the DA-662 has 4 Ethernet ports, and the DA-663 has 2 fiber Ethernet channels. The casing is a standard 1U, 19-inch wide rack-mounted rugged enclosure. The robust, rack-mountable mechanism design provides the hardened protection needed for industrial environment applications, and makes it easy for users to install the DA-661/662/663 on a standard 19-inch rack. The DA-661/662/663 are ideal for applications that require a distributed embedded technology, such as SCADA systems, plant floor automation, and power electricity monitoring applications.

The following topics are covered in this chapter:

- ❑ **Overview**
- ❑ **Software Architecture**
 - Journaling Flash File System (JFFS2)
 - Software Package

Overview

The DA-661/662/663 embedded computers are ideal for embedded applications. The computers feature a RISC CPU, RAM memory, and communication ports for connecting to RS-232/422/485 serial devices. In addition, the DA-661 has two Ethernet ports, the DA-662 has 4 Ethernet ports, and the DA-663 has 2 fiber Ethernet channels.

The DA-661/662/663 computers use an IXP-425 533 Mhz RISC CPU. Unlike the X86 CPU, which uses a CISC design, the RISC architecture and modern semiconductor technology provide the DA-661/662/663 with a powerful computing engine and communication functions, but without generating a lot of heat. The built-in 32 MB NOR Flash ROM and 128 MB SDRAM give you enough memory to install your application software directly on the computer. In addition, multiple LAN ports are built into the RISC CPU. The combination of advanced networking capability and control over serial devices makes the DA-661/662/663 an ideal communication platform for data acquisition and industrial control applications.

The DA-661/662/663's pre-installed Linux operating system (OS) provides an open software operating system for your software program development. Software written for desktop PCs is easily ported to the computer with a GNU cross compiler, without the need to modify the source code. The operating system, device drivers (e.g., Keypad, LCM, and Buzzer control) and your own applications can all be stored in the NOR Flash memory.

The DA-661/662/663 Linux Series consists of three models. All models of the DA-661/662/663-LX have 16 serial ports, and most of the same hardware and software features. The biggest difference is with the type and the number of network ports. The DA-661-LX has two Ethernet ports, the DA-662 has four Ethernet ports, and the DA-663 has 2 multi-mode fiber optic connectors.

Software Architecture

The Linux operating system that is pre-installed in the DA-661/662/663 follows the standard Linux architecture, making it easy to use programs that follow the POSIX standard. Program porting is done with the GNU Tool Chain provided by Moxa. In addition to Standard POSIX APIs, device drivers for the LCM, buzzer and keypad controls, and UART are also included in the Linux OS.

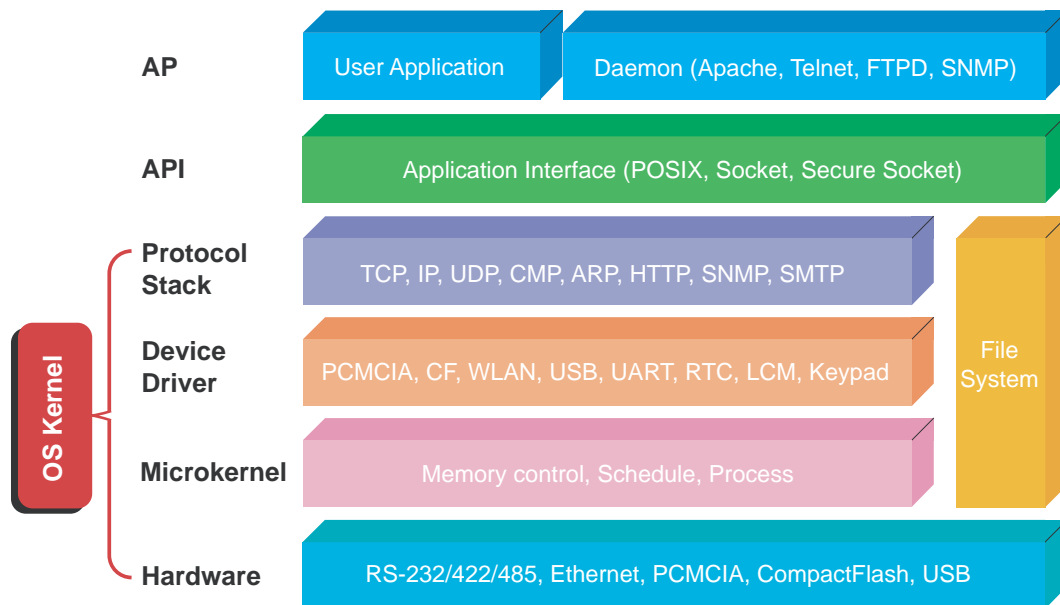

The DA-661/662/663's built-in Flash ROM is partitioned into **Boot Loader**, **Linux Kernel**, **Root File System**, and **User Root File System** partitions.

In order to prevent user applications from crashing the Root File System, the DA-661/662/663 uses a specially designed **Root File System with Protected Configuration** for emergency use. This **Root File System** comes with serial and Ethernet communication capability for users to load the **Factory Default Image** file. The user directory saves the user's settings and applications.

To improve system reliability, the DA-661/662/663 has a built-in mechanism that prevents the system from crashing. When the Linux kernel boots up, the kernel will mount the root file system for read only, and then enable services and daemons. During this time, the kernel will start searching for system configuration parameters via *rc* or *inittab*.

Normally, the kernel uses the Root File System to boot up the system. Since the Root File System is protected, and cannot be changed by the user, this provides a "safe" zone.

For more information about the memory map and programming, refer to Chapter 5, *Programmer's Guide*.

Journaling Flash File System (JFFS2)

The User Root File System in the flash memory is formatted with the **Journaling Flash File System (JFFS2)**. The formatting process places a compressed file system in the flash memory, transparent to the user.

The Journaling Flash File System (JFFS2), which was developed by Axis Communications in Sweden, puts a file system directly on the flash, instead of emulating a block device. It is designed for use on flash-ROM chips and recognizes the special write requirements of a flash-ROM chip. JFFS2 implements wear-leveling to extend the life of the flash disk, and stores the flash directory structure in the RAM. A log-structured file system is maintained at all times. The system is always consistent, even if it encounters crashes or improper power-downs, and does not require *fsck* (file system check) on boot-up.

JFFS2 is the newest version of JFFS. It provides improved wear-leveling and garbage-collection performance, improved RAM footprint and response to system-memory pressure, improved concurrency and support for suspending flash erases; marking of bad sectors with continued use of the remaining good sectors (which enhances the write-life of the devices), native data compression inside the file system design, and support for hard links.

The key features of JFFS2 are:

- Targets the Flash ROM directly
- Robustness
- Consistency across power failures
- No integrity scan (fsck) is required at boot time after normal or abnormal shutdown
- Explicit wear leveling
- Transparent compression

Although JFFS2 is a journaling file system, this does not preclude the loss of data. The file system will remain in a consistent state across power failures and will always be mountable. However, if the board is powered down during a write then the incomplete write will be rolled back on the next boot, but writes that have already been completed will not be affected.

Additional information about JFFS2 is available at:

<http://sources.redhat.com/jffs2/jffs2.pdf>

<http://developer.axis.com/software/jffs/>

<http://www.linux-mtd.infradead.org/>

Software Package

Boot Loader	Redboot (v1.92)
Kernel	Monta Vista embedded Linux 2.6.10
Protocol Stacks	ARP, PPP, CHAP, PAP, IPv4, ICMP, TCP, UDP, DHCP, FTP, SNMP V1/V2, HTTP, NTP, NFS, SMTP, SSH 1.0/2.0, SSL, Telnet, PPPoE, OpenVPN
File System	JFFS2, NFS, Ext2, Ext3, VFAT/FAT
OS shell command	bash
Busybox	Linux normal command utility collection
Utilities	
tinylogin	login and user manager utility
telnet	telnet client program
ftp	FTP client program
smtpclient	email utility
scp	Secure file transfer Client Program
Daemons	
pppd	dial in/out over serial port daemon
snmpd	snmpd agent daemon
telnetd	telnet server daemon
inetd	TCP server manager program
ftpd	ftp server daemon
apache	web server daemon
sshd	secure shell server
nfs-user-server	network file system server
openvpn	virtual private network
openssl	open SSL
Linux Tool Chain	
Gcc (V3.4.3)	C/C++ PC Cross Compiler
GDB (V6.3)	Source Level Debug Server
Glibc (V2.2.5)	POSIX standard C library

2

Getting Started

In this chapter, we explain how to connect the DA-661/662/663, turn on the power, and then get started using the programming and other functions.

The following topics are covered in this chapter:

- ❑ **Powering on the DA-661/662/663**
- ❑ **Connecting the DA-661/662/663 to a PC**
 - Serial Console
 - Telnet Console
 - SSH Console
- ❑ **Configuring the Ethernet Interface**
 - Modifying Network Settings with the Serial Console
 - Modifying Network Settings over the Network
 - Configuring the WLAN via the PCMCIA Interface
- ❑ **Test Program—Developing Hello.c**
 - Installing the Tool Chain (Linux)
 - Checking the Flash Memory Space
 - Compiling Hello.c
 - Uploading and Running the “Hello” Program
- ❑ **Developing Your First Application**
 - Testing Environment
 - Compiling tcps2.c
 - Uploading and Running the “tcps2-release” Program
 - Testing Procedure Summary

Powering on the DA-661/662/663

Connect the SG wire to the Shielded Contact located in the upper left corner of the DA-661/662/663, and then power on the computer by connecting it to the power adaptor. It takes about 30 to 60 seconds for the system to boot up. Once the system is ready, the Ready LED will light up, and the model name of the computer will appear on the LCM display.

NOTE After connecting the DA-661/662/663 to the power supply, it will take about 30 to 60 seconds for the operating system to boot up. The green Ready LED will not turn on until the operating system is ready.

Connecting the DA-661/662/663 to a PC

There are two ways to connect the DA-661/662/663 to a PC: (1) Through the serial console port, and (2) via Telnet over the network.

Serial Console

The serial console port gives users a convenient way of connecting to the DA-661/662/663's console utility. This method is particularly useful when using the computer for the first time. The signal is transmitted over a direct serial connection, so that you do not need to know any of the IP addresses in order to connect to the serial console utility.

Use the serial console port settings shown below.

Baudrate	115200 bps
Parity	None
Data bits	8
Stop bits:	1
Flow Control	None
Terminal	VT100

Once the connection is established, the following window will open.

```

Moxa Embedded Linux, Professional Edition
Moxa login: root
Password:
#####
###      ###      #####      #####      #####      ##
###      ###      ###      ###      ###      ###      ###
###      ###      ##      ##      ##      ##      ###
###      #####      ##      ##      ##      ##      #####
#####      ##      ##      ##      ##      ##      ##      ##
##      ##      ##      ##      ##      ##      ##      ##
##      ##      ##      ##      ##      ##      ##      ##
##      ##      ##      ##      ##      ##      ##      ##
##      ##      ##      ##      ##      ##      ##      ##
##      ##      ##      ##      ##      ##      ##      ##
#####      #      #####      #####      #####      #####
#####
For further information check:
http://www.moxa.com/
Mount user file system.
root@moxa:~#
    
```

To log in, type the Login name and password as requested. The default values are both **root**:

```

Login:    root
Password: root
    
```

Telnet Console

If you know at least one of the two IP addresses and netmasks, then you can use Telnet to connect to the DA-661/662/663's console utility. The default IP address and Netmask for each of the these ports are given below:

	Default IP Address	Netmask
LAN 1	192.168.3.127	255.255.255.0
LAN 2	192.168.4.127	255.255.255.0
LAN 3	192.168.5.127	255.255.255.0
LAN 4	192.168.6.127	255.255.255.0

Use a cross-over Ethernet cable to connect directly from your PC to the DA-661/662/663. You should first modify your PC's IP address and netmask so that your PC is on the same subnet as one of the DA-661/662/663's LAN ports. For example, if you connect to LAN 1, you can set your PC's IP address to 192.168.3.126 and netmask to 255.255.255.0. If you connect to the LAN 2, you can set your PC's IP address to 192.168.4.126 and netmask to 255.255.255.0.

NOTE The DA-661 and DA-663 have two LANs. The DA-662 has four LANS.

To connect to your local LAN with a hub or switch, use a straight-through Ethernet cable. The default IP addresses and netmasks are shown above. To log in, type the Login name and password as requested. The default values are both **root**:

Login: root
 Password: root

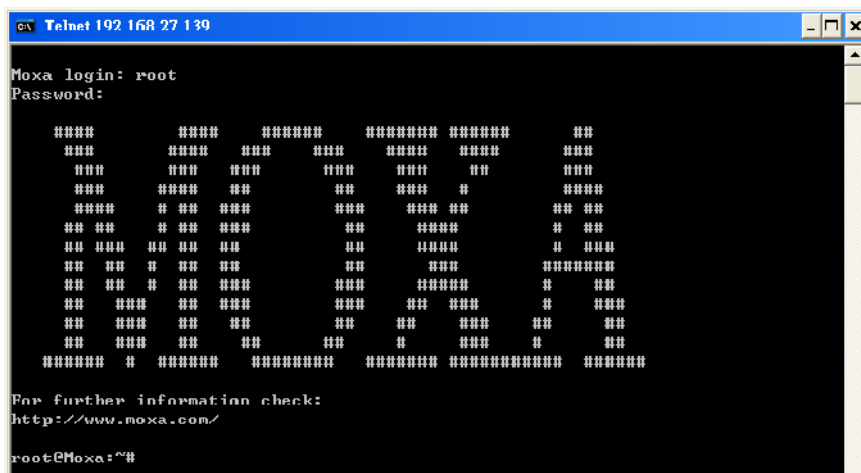

You can proceed with configuring network settings of the target computer when you reach the bash command shell. Configuration instructions are given in the next section.



ATTENTION

Serial Console Reminder

Remember to choose VT100 as the terminal type. Use the cable CBL-RJ45F9-150, which comes with the DA-661/662/663, to connect to the serial console port.

Telnet Reminder

When connecting to the DA-661/662/663 over a LAN, you must configure your PC's Ethernet IP address to be on the same subnet as the DA-661/662/663 that you wish to contact. If you do not get connected on the first try, re-check the serial and IP settings, and then unplug and re-plug the DA-661/662/663's power cord.

The DA-662 has 4 LAN ports; LAN 3 and LAN 4 are only available on the DA-662.

SSH Console

The DA-661/662/663 supports an SSH Console to provide users with better security options.

Windows Users

Click on the link <http://www.chiark.greenend.org.uk/~sgtatham/putty/download.html> to download PuTTY (free software) to set up an SSH console for the DA-661/662/663 in a Windows environment. The following figure shows a simple example of the configuration that is required.

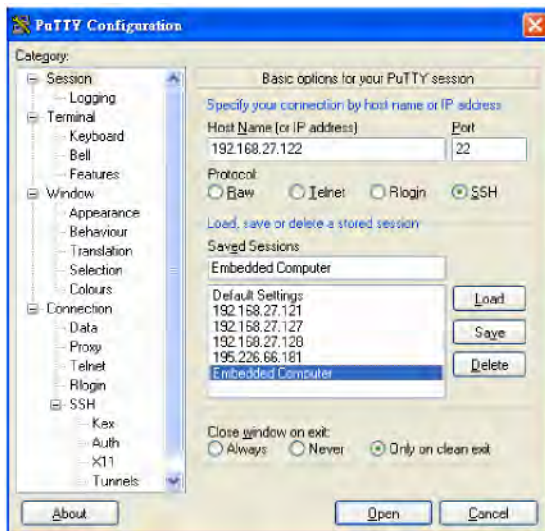

Linux Users

From a Linux machine, use the “ssh” command to access the DA-661/662/663’s console utility via SSH.

```
#ssh 192.168.3.127
```

Select **yes** to complete the connection.

```
[root@bee_notebook root]# ssh 192.168.3.127
The authenticity of host '192.168.3.127 (192.168.3.127)' can't be established.
RSA key fingerprint is 8b:ee:ff:84:41:25:fc:cd:2a:f2:92:8f:cb:1f:6b:2f.
Are you sure you want to continue connection (yes/no)? yes_
```

NOTE SSH provides better security compared to Telnet for accessing the DA-661/662/663’s Console utility over the network.

Configuring the Ethernet Interface

The network settings of the DA-661/662/663 can be modified from the serial Console, or online over the network.

Modifying Network Settings with the Serial Console

In this section, we use the serial console to configure the network settings of the target computer.

1. Follow the instructions given in a previous section to access the Console Utility of the target computer via the serial Console port, and then type **#cd /etc/network** to change directories.

```
root@Moxa:# cd /etc/network/
root@Moxa:/etc/network/#
```

2. Type **#vi interfaces** to edit the network configuration file with vi editor. You can configure the Ethernet ports of the DA-661/662/663 for **static** or **dynamic** (DHCP) IP addresses.

Static IP addresses:

As shown below, 4 network addresses need to be modified: **address**, **network**, **netmask**, and **broadcast**. The default IP addresses are 192.168.3.127 for LAN1 and 192.168.4.127 for LAN2, with default netmask of 255.255.255.0.

```
# We always want the loopback interface.

auto eth0 eth1 eth2 eth3 eth4 lo
iface lo inet loopback

# embedded ethernet LAN1
iface eth0 inet static
    address 192.168.3.127
    network 192.168.3.0
    netmask 255.255.255.0
    broadcast 192.168.3.255

# embedded ethernet LAN2
iface eth1 inet static
    address 192.168.4.127
    network 192.168.4.0
    netmask 255.255.255.0
    broadcast 192.168.4.255

# embedded ethernet LAN3
iface eth2 inet static
    address 192.168.5.127
    network 192.168.5.0
```

Dynamic IP addresses:

By default, the DA-661/662/663 is configured for “static” IP addresses. To configure one or both LAN ports to request an IP address dynamically, replace **static** with **dhcp** and then delete the address, network, netmask, and broadcast lines.

Default Setting for LAN1	Dynamic Setting using DHCP
<pre>iface eth0 inet static address 192.168.3.127 network: 192.168.3.0 netmask 255.255.255.0 broadcast 192.168.3.255</pre>	<pre>iface eth0 inet dhcp</pre>

```
Auto eth0 eth1 lo
iface lo inet loopback

iface eth0 inet dhcp
iface eth1 inet dhcp
```

- After the boot settings of the LAN interface have been modified, issue the following command to activate the LAN settings immediately:

```
#/etc/init.d/networking restart
```

NOTE	After changing the IP settings, use the networking restart command to activate the new IP address. However, the LCM display will still show the old IP address. To update the LCM display, you will need to reboot the DA-661/662/663.
------	---

Modifying Network Settings over the Network

IP settings can be activated over the network, but the new settings will not be saved to the flash ROM without modifying the file `/etc/network/interfaces`.

For example, type the command `#ifconfig eth0 192.168.1.1` to change the IP address of LAN1 to 192.168.1.1.

```
root@moxa:~# ifconfig eth0 192.168.1.1
root@moxa:~# cd /etc/network/
```

Configuring the WLAN via the PCMCIA Interface

The following IEEE802.11g wireless modules are supported:

- ASUS—WL-107g
- CNET—CWC-854 (181D version)
- Edmiac—EW-7108PCg
- Amigo—AWP-914W
- GigaByte—GN-WMKG
- Other brands that use the Ralink RT2500 series chip set

To configure the WLAN for IEEE802.11g:

1. First unplug the CardBus wireless LAN card.
2. Use the command `#vi /etc/network/interfaces` to open the “interfaces” configuration file with vi editor, and then edit the 802.11g network settings (the wireless interface name should be “eth2” on the DA-661/663; on the DA-662, it should be “eth4”).

```
# We always want the loopback interface.

auto eth0 eth1 eth2 eth3 eth4 lo
iface lo inet loopback

# embedded ethernet LAN1
iface eth0 inet static
    address 192.168.3.127
    network 192.168.3.0
    netmask 255.255.255.0
    broadcast 192.168.3.255

# Wireless/embedded ethernet LAN2
iface eth1 inet static
    address 192.168.4.127
    network 192.168.4.0
    netmask 255.255.255.0
    broadcast 192.168.4.255

# embedded ethernet LAN3
iface eth0 inet static
    address 192.168.5.127
    network 192.168.5.0
    netmask 255.255.255.0
    broadcast 192.168.5.255

# embedded ethernet LAN4
iface eth1 inet static
    address 192.168.6.127
    network 192.168.6.0
    netmask 255.255.255.0
    broadcast 192.168.6.255

# Wireless/ethernet LAN7
iface eth0 inet static
    address 192.168.7.127
    network 192.168.7.0
    netmask 255.255.255.0
    broadcast 192.168.7.255
```

- Additional WLAN parameters are contained in the file **RT2500STA.dat**. To open the file, navigate to the RT2500STA folder and invoke vi, or type the following command `#vi /etc/Wireless/RT2500STA/RT2500STA.dat` to edit the file with vi editor. Setting options for the various parameters are listed below the figure.

```
[Default]
CountryRegion=0
WirelessMode=0
SSID=MOXASYS
NetworkType=Infra
Channel=0
AuthMode=OPEN
EncryptType=WEP
DefaultKeyID=1
Key1Str=1111111111
Key2Str=
Key3
Key4
WpaPsk=abcdefghijklmnopqrstuvwxy
TXBurst=0
TurboRate=0
BGProtection=0
ShortSlot=0
Key3
Key4
WpaPsk=abcdefghijklmnopqrstuvwxy
```

CountryRegion—sets the channels for your particular country / region

Setting	Explanation
0	use channels 1 to 11
1	use channels 1 to 11
2	use channels 1 to 13
3	use channels 10, 11
4	use channels 10 to 13
5	use channel 14
6	use channels 1 to 14
7	use channels 3 to 9

WirelessMode—sets the wireless mode

Setting	Explanation
0	11b/g mixed
1	11b only
2	11g only

SSID—sets the softAP SSID

Setting
Any 32-byte string

NetworkType—sets the wireless operation mode

Setting	Explanation
Infra	Infrastructure mode (uses access points to transmit data)
Adhoc	Adhoc mode (transmits data from host to host)

Channel—sets the channel

Setting	Explanation
0	auto
1 to 14	the channel you want to use

AuthMode—sets the authentication mode

Setting
OPEN
SHARED
WPAPSK
WPANONE

EncrypType—Sets encryption type

Setting
NONE
WEP
TKIP
AES

DefaultKeyID—sets default key ID

Setting
1 to 4

Key1Str, Key2Str, Key3Str, Key4Str—sets strings Key1 to Key4

Setting
The keys can be input as 5 ascii characters, 10 hex numbers, 13 ascii characters, or 26 hex numbers

TxBurst—WPA pre-shared key

Setting
8 to 64 ASCII characters

WPAPSK—enables or disables TxBurst

Setting
8 to 63 ASCII or 64 HEX characters

TurboRate—enables or disables TurboRate

Setting	Explanation
0	disable
1	enable

BGProtection—sets 11b/11g protection (this function is for engineering testing only)

Setting	Explanation
0	auto
1	always on
2	always off

ShortSlot—enables or disables the short slot time

Setting	Explanation
0	disable
1	enable

TxRate—sets the TxRate

Setting	Explanation
0	Auto
1	1 Mbps
2	2 Mbps
3	5.5 Mbps
4	11 Mbps
5	6 Mbps
6	9 Mbps
7	12 Mbps
8	18 Mbps
9	24 Mbps
10	36 Mbps
11	48 Mbps
12	54 Mbps

RTSThreshold—sets the RTS threshold

Setting
1 to 2347

FragThreshold—sets the fragment threshold

Setting
256 to 2346

Example 1: Configure wireless LAN to link to AP that is OPEN/NONE (Authentication/Encryption)

```
[Default]
CountryRegion=0
WirelessMode=0
SSID=DN_3Com
NetworkType=Infra
Channel=0
AuthMode=OPEN
EncrypType=NONE
DefaultKeyID=1
Key1Str=0123456789
Key2Str=
Key3Str=
Key4Str=
WPAPSK=1111111111
TXBurst=0
TurboRate=0
BGProtection=0
ShortSlot=0
TxRate=0
RTSThreshold=2312
FragThreshold=2312
PSMode=CAM
```

Example 2: Configure wireless LAN to link to AP that is SHARED/WEP (Authentication/Encryption)

```
[Default]
CountryRegion=0
WirelessMode=0
SSID=DN_3Com
NetworkType=Infra
Channel=0
AuthMode=SHARED
EncrypType=WEP
DefaultKeyID=1
Key1Str=0123456789
Key2Str=
Key3Str=
Key4Str=
WPAPSK=1111111111
TXBurst=0
TurboRate=0
BGProtection=0
ShortSlot=0
TxRate=0
RTSThreshold=2312
FragThreshold=2312
PSMode=CAM
```

Example 3: Configure wireless LAN to link to AP that is WPAPSK/TKIP (Authentication/Encryption)

```
[Default]
CountryRegion=0
WirelessMode=0
SSID=DN_3Com
NetworkType=Infra
Channel=0
AuthMode=WPAPSK
EncrypType=TKIP
DefaultKeyID=1
Key1Str=0123456789
Key2Str=
Key3Str=
Key4Str=
WPAPSK=1111111111
TXBurst=0
TurboRate=0
BGProtection=0
ShortSlot=0
TxRate=0
RTSThreshold=2312
FragThreshold=2312
PSMode=CAM
```

Example 4: Configure wireless LAN to link to AP that is WPAPSK/AES (Authentication/Encryption)

```
[Default]
CountryRegion=0
WirelessMode=0
SSID=DN_3Com
NetworkType=Infra
Channel=0
AuthMode=WPAPSK
EncrypType=AES
DefaultKeyID=1
Key1Str=0123456789
Key2Str=
Key3Str=
Key4Str=
WPAPSK=1111111111
TXBurst=0
TurboRate=0
BGProtection=0
ShortSlot=0
TxRate=0
RTSThreshold=2312
FragThreshold=2312
PSMode=CAM
```

Test Program—Developing Hello.c

In this section, we use the standard “**Hello**” programming example to illustrate how to develop a program for the DA-661/662/663. In general, program development involves the following seven steps.

Step 1:

Connect the DA-661/662/663 to a Linux PC.

Step 2:

Install Tool Chain (GNU Cross Compiler & glibc).

Step 3:

Set the cross compiler and glibc environment variables.

Step 4:

Prepare the code and compile the program.

Step 5:

Download the program to the DA-661/662/663 via FTP or NFS.

Step 6:

Debug the program

→ If bugs are found, return to Step 4.

→ If no bugs are found, continue with Step 7.

Step 7:

Back up the user directory (distribute the program to additional DA-661/662/663 units if needed).

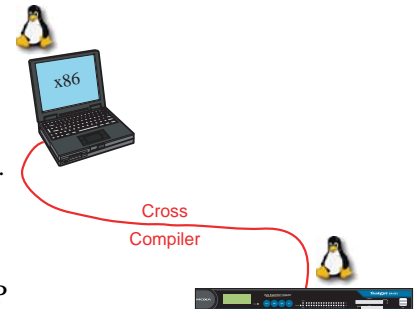

Installing the Tool Chain (Linux)

The PC must have the Linux Operating System pre-installed before installing the DA-661/662/663 GNU Tool Chain. Redhat 7.3/8.0, Fedora core, and compatible versions are recommended. The Tool Chain requires about 100 MB of hard disk space on your PC. The DA-661/662/663 Tool Chain software is located on the DA-661/662/663 CD. To install the Tool Chain, insert the CD into your PC and then issue the following commands:

```
#mount /dev/cdrom /mnt/cdrom
#cp /mnt/cdrom/tool-chain/linux/install.sh /tmp/
#sh /tmp/install.sh
```

The Tool Chain will be installed automatically on your Linux PC within a few minutes. Before compiling the program, be sure to set the following path first, since the Tool Chain files, including the compiler, link, library, and include files are located in this directory.

```
PATH=/usr/local/xscale_be/bin:$PATH
```

Setting the path allows you to run the compiler from any directory.

NOTE	Refer to Appendix B for an introduction to the Windows Tool Chain. In this chapter, we use the Linux tool chain to illustrate the cross compiling process.
------	--

Checking the Flash Memory Space

The DA-661/662/663 uses a specially designed root file system. Only the **/tmp**, **/etc**, **/home**, and **/root** directories are writable. Others are read-only. The writable directories are mounted on **/dev/mtdblock3**. If the **/dev/mtdblock3** is full, you will not be able to save data to the Flash ROM. Use the following command to calculate the amount of “Available” flash memory:

```
>df -h
```

```
root@Moxa:/# df -h
Filesystem      Size      Used Available Use% Mounted on
/dev/mtdblock2  14.0M    10.9M     3.1M   78% /
/dev/ram15       1.7M      18.0k     1.6M    1% /dev
/dev/ram0        499.0k    29.0k    445.0k    6% /var
/dev/mtdblock3  15.8M     2.4M    13.3M   16% /tmp
/dev/mtdblock3  15.8M     2.4M    13.3M   16% /home
/dev/mtdblock3  15.8M     2.4M    13.3M   16% /etc
tmpfs           61.9M      0      61.9M    0% /dev/shm
root@Moxa:/#
```

If there isn't enough “Available” space for your application, you will need to delete some existing files. To do this, use the console cable to connect your PC to the DA-661/662/663, and then use the console utility to delete the files from the DA-661/662/663's flash memory.

Compiling Hello.c

The CD included with the product contains several example programs. Here we use **Hello.c** as an example to show you how to compile and run your applications. Type the following commands from your PC to copy the files used for this example from the CD to your computer's hard drive:

```
# cd /tmp/
# mkdir example
# cp -r /mnt/cdrom/example/* /tmp/example
```

To compile the program, go to the **Hello** subdirectory and issue the following commands:

```
#cd example/hello #make
```

You should receive the following response:

```
[root@localhost hello]# make
xscale_be-gcc -o hello-release hello.c
xscale_be-strip -s hello-release
xscale_be-gcc -ggdb -o hello-debug hello.c
[root@localhost hello]# _
```

Next, execute **make** to generate **hello-release** and **hello-debug**, which are described below:

hello-release—an IXP platform execution file (created specifically to run on the DA-661/662/663)

hello-debug—an IXP platform GDB debug server execution file (see Chapter 5 for details about the GDB debug tool).

NOTE

Be sure to type the **#make** command from within the **/tmp/example/hello** directory, since UC's tool chain puts a specially designed **Makefile** in that directory. This special Makefile uses the mxscale-gcc compiler to compile the hello.c source code for the Xscale environment. If you type the **#make** command from within any other directory, Linux will use the x86 compiler (for example, cc or gcc).

Refer to Chapter 5 to see a Make file example.

Uploading and Running the “Hello” Program

Use the following command to upload **hello-release** to the DA-661/662/663 via FTP.

1. From the PC, type:

```
#ftp 192.168.3.127
```
2. Use the bin command to set the transfer mode to Binary mode, and then use the put command to initiate the file transfer:

```
ftp> bin
ftp> put hello-release
```

3. From the DA-661/662/663, type:

```
# chmod +x hello-release
# ./hello-release
```

The word **Hello** will be printed on the screen.

```
root@Moxa:~# ./hello-release
Hello
```

Developing Your First Application

We use the tcps2 example to illustrate how to build an application. The procedure outlined in the following subsections will show you how to build a TCP server program with serial port communication that runs on the DA-661/662/663.

Testing Environment

The tcps2 example demonstrates a simple application program that delivers transparent, bi-directional data transmission between the DA-661/662/663's serial and Ethernet ports. As illustrated in the following figure, the purpose of this application is to transfer data between PC 1 and the DA-661/662/663 via an RS-232 connection. At the remote site, data can be transferred between the DA-661/662/663's Ethernet port and PC 2 over an Ethernet connection.

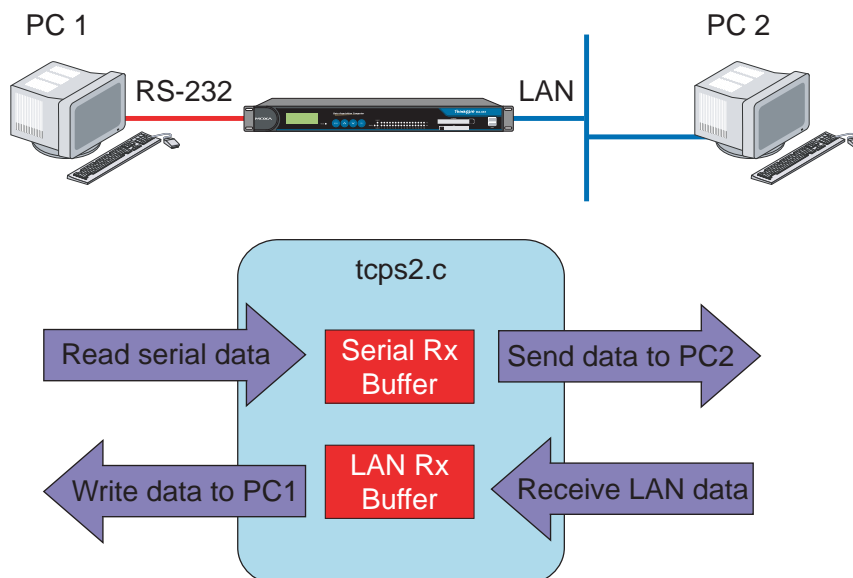

Compiling tcps2.c

The source code for the tcps2 example is located on the CD-ROM at **CD-ROM://example/TCPServer2/tcps2.c**. Use the following commands to copy the file to a specific directory on your PC. We use the directory **/home/1st_application/**. Note that you need to copy 3 files—**Makefile**, **tcps2.c**, **tcpsp.c**—from the CD-ROM to the target directory.

```
#mount -t iso9660 /dev/cdrom /mnt/cdrom
#cp /mnt/cdrom/example/TCPServer2/tcps2.c/home/1st_application/tcps2.c
#cp /mnt/cdrom/example/TCPServer2/tcpsp.c/home/1st_application/tcpsp.c
#cp /mnt/cdrom/example/TCPServer2/Makefile.c/home/1st_application/Makefile.c
```

Type **#make** to compile the example code:

You will see the following response, indicating that the example program was compiled successfully.

```
root@server11:/home/1st_application
[root@server11 1st_application]# pwd
/home/da661/662663/1st_application
[root@server11 1st_application]# ll
total 20
-rw-r--r-- 1 root root 514 Nov 27 11:52 Makefile
-rw-r--r-- 1 root root 4554 Nov 27 11:52 tcps2.c
-rw-r--r-- 1 root root 6164 Nov 27 11:55 tcpsp.c
[root@server11 1st_application]# make_
xscale_be-gcc -o tcps2-release tcps2.c
xscale_be-strip -s tcps2-release
xscale_be-gcc -o tcpsp-release tcpsp.c
xscale_be-strip -s tcpsp-release
xscale_be-gcc -ggdb -o tcps2-debug tcps2.c
xscale_be-gcc -ggdb -o tcpsp-debug tcpsp.c
You have new mail in /var/spool/mail/root
[root@server11 1st_application]# ll
[root@server11 1st_application]# ll
total 92
-rw-r--r-- 1 root root 514 Nov 27 11:52 Makefile
-rwxr-xr-x 1 root root 25843 Nov 27 12:03 tcps2-debug
-rwxr-xr-x 1 root root 4996 Nov 27 12:03 tcps2-release
-rw-r--r-- 1 root root 4554 Nov 27 11:52 tcps2.c
-rwxr-xr-x 1 root root 26823 Nov 27 12:03 tcpsp-debug
-rwxr-xr-x 1 root root 5396 Nov 27 12:03 tcpsp-release
-rw-r--r-- 1 root root 6164 Nov 27 11:55 tcpsp.c
[root@server11 1st_application]#
```

Two executable files, **tcps2-release** and **tcps2-debug**, are created.

tcps2-release—an IXP platform execution file (created specifically to run on the DA-661/662/663).

tcps2-debug—an IXP platform GDB debug server execution file (see Chapter 5 for details about the GDB debug tool).

NOTE If you get an error message at this point, it could be because you neglected to put **tcps2.c** and **tcpsp.c** in the same directory. The example Makefile we provide is set up to compile both **tcps2** and **tcpsp** into the same project Makefile. Alternatively, you could modify the Makefile to suit your particular requirements.

Uploading and Running the “tcps2-release” Program

Use the following commands to use FTP to upload **tcps2-release** to the DA-661/662/663.

1. From the PC, type:

```
#ftp 192.168.3.127
```

2. Next, use the **bin** command to set the transfer mode to **Binary**, and the **put** command to initiate the file transfer:

```
ftp> bin
ftp> put tcps2-release
```

```
root@server11:/home/1st_application
[root@server11 1st_application]# ftp 192.168.3.127
Connected to 192.168.3.127 220
Moxa FTP server (Version wu-2.6.1(2) Mon Nov 24 12:17:04 CST 2003) ready.
530 Please login with USER and PASS.
530 Please login with USER and PASS.
KERBEROS_V4 rejected as an authentication type
Name (192.168.3.127:root): root
331 Password required for root.
Password:
230 User root logged in.
Remote system type is UNIX.
Using binary mode to transfer files.
ftp> bin
200 Type set to I.
ftp> put tcps2-release
local: tcps2-release remote: tcps2-release
277 Entering Passive Mode (192.168.3.127.82.253)
150 Opening BINARY mode data connection for tcps2-release.
226 Transfer complete
4996 bytes sent in 0.00013 seconds (3.9e+04 Kbytes/s)
ftp> ls
227 Entering Passive Mode (192.168.3.127.106.196)
150 Opening ASCII mode data connection for /bin/ls.
-rw----- 1 root root 899 Jun 10 08:11 bash_history
-rw-r--r-- 1 root root 4996 Jun 12 02:15 tcps2-release
226 Transfer complete
ftp> █
```

3. From the DA-661/662/663, type:

```
# chmod +x tcps2-release
# ./tcps2-release &
```

```
192.168.3.127 - PuTTY
root@Moxa:~# ls -al
drwxr-xr-x 2 root root 0 Jun 12 02:14
drwxr-xr-x 15 root root 0 Jan 1 1970
-rw----- 1 root root 899 Jun 10 08:11 .bash_history
-rw-r--r-- 1 root root 4996 Jun 12 02:15 tcps2-release
root@Moxa:~# chmod +x tcps2-release
root@Moxa:~# ls -al
drwxr-xr-x 2 root root 0 Jun 12 02:14
drwxr-xr-x 15 root root 0 Jan 1 1970
-rw----- 1 root root 899 Jun 10 08:11 .bash_history
-rwxr-xr-x 1 root root 4996 Jun 12 02:15 tcps2-release
root@Moxa:~# █
```

4. The program should start running in the background. Use either the `#jobs` or `#ps -ef` command to check if the `tcps2` program is actually running in the background.

`#jobs // use this command to check if the program is running`

```
192.168.3.127 - PuTTY
root@Moxa:~# ls -al
drwxr-xr-x  2 root root    0 Jun 12 02:14
drwxr-xr-x 15 root root    0 Jan  1  1970
-rw-----  1 root root   899 Jun 10 08:11 .bash_history
-rw-r--r--  1 root root  4996 Jun 12 02:15 tcps2-release
root@Moxa:~# chmod +x tcps2-release
root@Moxa:~# ls -al
drwxr-xr-x  2 root root    0 Jun 12 02:14
drwxr-xr-x 15 root root    0 Jan  1  1970
-rw-----  1 root root   899 Jun 10 08:11 .bash_history
-rwxr-xr-x  1 root root  4996 Jun 12 02:15 tcps2-release
root@Moxa:~# ./tcps2-release &
[1] 187
start
root@Moxa:~# jobs
[1]+  Running      ./tcps2-release &
root@Moxa:~# █
```

NOTE Use the `kill` command for job number 1 to terminate this program: `#kill %1`

`#ps -ef // use this command to check if the program is running`

```
192.168.3.127 - PuTTY
[1]+  Running      ./tcps2-release &
root@Moxa:~# ps -ef
PID  Uid    VmSize  Stat  Command
  1  root      1296  S    init
  2  root          S    [keventd]
  3  root          S    [ksoftirqd_CPU0]
  4  root          S    [kswapd]
  5  root          S    [bdflush]
  6  root          S    [kupdated]
  7  root          S    [mtdblockd]
  8  root          S    [khubd]
 10  root          S    [jffs2_gcd_mtd3]
 32  root          D    [ixp425_csr]
 34  root          S    [ixp425_eth0]
 36  root          D    [ixp425_eth1]
 38  root      1256  S    stdef
 46  root      1368  S    /usr/sbin/inetd
 52  root      4464  S    /usr/sbin/httpd
 53  nobody   4480  S    /usr/sbin/httpd
 54  nobody   4480  S    /usr/sbin/httpd
 64  nobody   4480  S    /usr/sbin/httpd
 65  nobody   4480  S    /usr/sbin/httpd
 66  nobody   4480  S    /usr/sbin/httpd
 88  bin      1460  S    /sbin/portmap
100  root      1556  S    /usr/sbin/rpc.statd
104  root      4044  S    /usr/sbin/snmpd -s -l /dev/null
106  root      2832  S    /usr/sbin/snmptrapd -s
135  root      1364  S    /sbin/cardmgr
139  root      1756  S    /usr/sbin/rpc.nfsd
141  root      1780  S    /usr/sbin/rpc.mountd
148  root      2960  S    /usr/sbin/sshd
156  root      1272  S    /bin/reportip
157  root      1532  S    /sbin/getty 115200 ttyS0
158  root      1532  S    /sbin/getty 115200 ttyS1
162  root      3652  S    /usr/sbin/sshd
```

```
163 root      2208 S    -bash
169 root      2192 S    ftpd: 192.168.3.110: root: IDLE
187 root      1264 S    ./tcps2-release
188 root      1592 S    ps -ef
root@Moxa:~#
```

NOTE Use the **kill -9** command for PID 187 to terminate this program: **#kill -9 %187**

Testing Procedure Summary

1. Compile **tcps2.c** (**#make**).
2. Upload and run **tcps2-release** in the background (**#!/tcps2-release &**).
3. Check that the process is running (**#jobs** or **#ps -ef**).
4. Use a serial cable to connect PC1 to the DA-661/662/663's serial port 1.
5. Use an Ethernet cable to connect PC2 to the DA-661/662/663.
6. On PC1: If running Windows, use HyperTerminal (**38400, n, 8, 1**) to open COMn.
7. On PC2: Type **#telnet 192.168.3.127 4001**.
8. On PC1: Type some text on the keyboard and then press **Enter**.
9. On PC2: The text you typed on PC1 will appear on PC2's screen.

The testing environment is illustrated in the following figure. However, note that there are limitations to the example program **tcps2.c**.

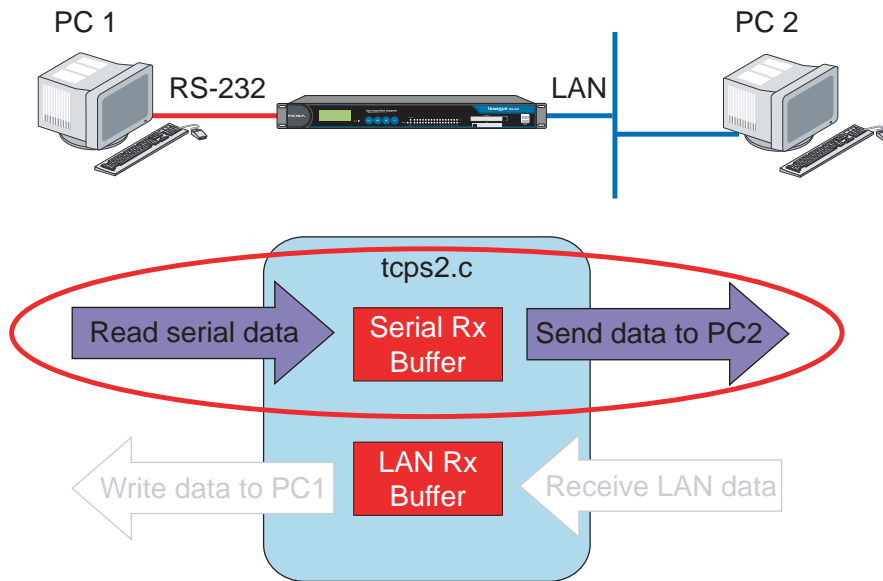

NOTE The **tcps2.c** application is a simple example designed to give users a basic understanding of the concepts involved in combining Ethernet communication and serial port communication. However, the example program has some limitations that make it unsuitable for real-life applications.

1. The serial port is in canonical mode and block mode, making it impossible to send data from the Ethernet side to the serial side (i.e., from PC 2 to PC 1 in the above example).
2. The Ethernet side will not accept multiple connections.

Managing Embedded Linux

This chapter includes information about version control, deployment, updates, and peripherals. The information in this chapter will be particularly useful when you need to run the same application on several DA-661/662/663 units.

The following topics are covered in this chapter:

- ❑ **System Version Information**
- ❑ **System Image Backup**
 - Upgrading the Firmware
 - Loading Factory Defaults
- ❑ **Enabling and Disabling Daemons**
- ❑ **Setting the Run-level**
- ❑ **Adjusting the System Time**
 - Setting the Time Manually
 - NTP Client
 - Updating the Time Automatically
- ❑ **Cron—Daemon for Executing Scheduled Commands**
- ❑ **Connecting Peripherals**
 - USB Mass Storage
 - CF Mass Storage

System Version Information

To determine the hardware capability of your DA-661/662/663, and what kind of software functions are supported, check the version numbers of your DA-661/662/663's firmware version. Contact Moxa to determine the hardware version. You will need the **Production S/N** (Serial number), which is located on the DA-661/662/663's bottom label.

To check the kernel version, type:

```
#kversion
```

```
192.168.3.127 - PuTTY
root@Moxa:~# kversion
1.0
root@Moxa:~# █
```

System Image Backup

Upgrading the Firmware

The DA-661/662/663's bios, kernel, mini file system, and user file system are combined into one firmware file, which can be downloaded from Moxa's website (www.moxa.com). The name of the file has the form **DA66X-x.x.x.frm**, with "x.x.x" indicating the firmware version. To upgrade the firmware, download the firmware file to a PC, and then transfer the file to the DA-661/662/663 unit via a serial Console or Telnet Console connection.



ATTENTION

Upgrading the firmware will erase all data on the Flash ROM

If you are using the ramdisk to store code for your applications, beware that updating the firmware will erase all of the data on the Flash ROM. You should back up your application files and data before updating the firmware.

Since different Flash disks have different sizes, it's a good idea to check the size of your Flash disk before upgrading the firmware, or before using the disk to store your application and data files. Use the `#df -h` command to list the size of each memory block, and how much free space is available in each block.

```
192.168.3.127 - PuTTY
root@Moxa:~# df -h
Filesystem      Size      Used Available Use% Mounted on
/dev/mtdblock2  14.0M    11.2M      2.8M   80% /
/dev/ram15       1.7M     18.0k     1.6M    1% /dev
/dev/ram0        499.0k   34.0k    440.0k    7% /var
/dev/mtdblock3  15.8M     2.6M    13.1M   17% /tmp
/dev/mtdblock3  15.8M     2.6M    13.1M   17% /home
/dev/mtdblock3  15.8M     2.6M    13.1M   17% /etc
root@Moxa:~# upramdisk
root@Moxa:~# df -h
Filesystem      Size      Used Available Use% Mounted on
/dev/mtdblock2  14.0M    11.2M      2.8M   80% /
/dev/ram15       1.7M     18.0k     1.6M    1% /dev
/dev/ram0        499.0k   34.0k    440.0k    7% /var
/dev/mtdblock3  15.8M     2.6M    13.1M   17% /tmp
/dev/mtdblock3  15.8M     2.6M    13.1M   17% /home
/dev/mtdblock3  15.8M     2.6M    13.1M   17% /etc
/dev/ram1        38.7M    13.0k    36.7M    0% /mnt/ramdisk
root@Moxa:~# cd /mnt/ramdisk/
root@Moxa:/mnt/ramdisk#
```

The following instructions give the steps required to save the firmware file to the DA-661/662/663's RAM disk, and then upgrade the firmware.

1. Type the following commands to enable the RAM disk:

```
#upramdisk
#cd /mnt/ramdisk
```

2. Type the following commands to use the DA-661/662/663's built-in FTP client to transfer the firmware file (**DA66X-x.x.x.frm**) from the PC to the DA-661/662/663:

```
/mnt/ramdisk> ftp <destination PC's IP> Login Name: xxxxx
Login Password: xxxxx
ftp> bin
ftp> get DA66X-x.x.x.frm
```

```
192.168.3.127 - PuTTY
root@moxa:/mnt/ramdisk# ftp 192.168.3.193
Connected to 192.168.3.193 (192.168.3.193).
220 TYPSoft FTP Server 1.10 ready...
Name (192.168.3.193:root): root
331 Password required for root.
Password:
230 User root logged in.
Remote system type is UNIX.
Using binary mode to transfer files.
ftp> cd newsw
250 CWD command successful. "/C:/ftproot/newsw/" is current directory.
ftp> bin
200 Type set to I.
ftp> ls
200 Port command successful.
150 Opening data connection for directory list.
drw-rw-rw-  1 ftp  ftp   0 Nov 30 10:03 .
drw-rw-rw-  1 ftp  ftp   0 Nov 30 10:03 ..
-rw-rw-rw-  1 ftp  ftp 12904012 Nov 29 10:24 DA66X-1.0.frm
-rw-rw-rw-  1 ftp  ftp 11082828 Nov 29 10:24 DA66X_rootdisk-1.0.frm
226 Transfer complete.
ftp> get DA66X-1.0.frm
local: DA66X-1.0.frm remote: DA66X-1.0.frm
200 Port command successful.
150 Opening data connection for DA66X-1.0.frm
226 Transfer complete.
12904012 bytes received in 2.17 secs (5925.8 kB/s)
ftp> █
```

3. Next, use the **upfirm** command to upgrade the kernel and root file system:

```
#upfirm DA66X-x.x.x.frm
```

```
192.168.3.127 - PuTTY
root@moxa:/mnt/ramdisk# upfirm DA66X-1.0.frm
DA-66X Upgrade firmware utility version 1.0.
To check source firmware file context.
The source firmware file context is OK.
This step will upgrade firmware. All the data on flash will be destroyed.
Do you want to continue? (Y/N) :
Now upgrade the file [redboot].
Format MTD device [/dev/mtd0] ...
MTD device [/dev/mtd0] erase 128 Kibyte @ 60000 -- 100% complete.
Wait to write file ...
Completed 100%
Now upgrade the file [kernel].
Format MTD device [/dev/mtd1] ...
MTD device [/dev/mtd1] erase 128 Kibyte @ 1a0000 -- 100% complete.
Wait to write file ...
Completed 100%
```

```

Now upgrade the file [root-file-system].
Format MTD device [/dev/mtd2] ...
MTD device [/dev/mtd2] erase 128 Kibyte @ e00000 -- 100% complete.
Wait to write file ...
Completed 100%
Now upgrade the file [directory].
Format MTD device [/dev/mtd5] ...
MTD device [/dev/mtd5] erase 128 Kibyte @ 20000 -- 100% complete.
Wait to write file ...
Completed 100% Now upgrade the new configuration file.
Upgrade the firmware is OK. Rebooting

```

Loading Factory Defaults

To load the system's factory default settings, press the reset-to-default button for at least 5 seconds. Doing so will destroy all of the files in the **/home** and **/etc** directories. While holding the button for the first 5 seconds, the ready LED will blink once each second. After holding the button continuously for more than 5 seconds, the ready LED will switch off, indicating that the factory defaults have been loaded.

Enabling and Disabling Daemons

The following daemons are enabled when the DA-661/662/663 boots up for the first time.

```

snmpd .....SNMP Agent daemon
telnetd .....Telnet Server / Client daemon
inetd .....Internet Daemons
ftpd.....FTP Server / Client daemon
sshd .....Secure Shell Server daemon
httpd.....Apache WWW Server daemon
nfsd.....Network File System Server daemon

```

Type the command **ps -ef** to list all processes currently running.

```

192.168.3.127 - PuTTY
root@Moxa:~# cd /etc
root@Moxa:/etc# ps -ef
  PID  Uid    VmSize  Stat  Command
    1  root      492  S    init [3]
    2  root          SW<  [ksoftirqd/0]
    3  root          SW<  [desched/0]
    4  root          SW<  [events/0]
    5  root          SW<  [khelper]
   10  root          SW<  [kthread]
   13  root          SW<  [kblockd/0]
   86  root          SW    [pdflush]
   87  root          SW    [pdflush]
   89  root          SW<  [aio/0]
   43  root          SW    [khubd]
   88  root          SW    [kswapd0]
  605  root          SW    [swapper]
  606  root          SW    [swapper]
  607  root          SW    [swapper]
  645  root          SW    [mtdblockd]
  783  root          DW<  [EthDB event thr]
  786  root          SW<  [ixp400_eth]
  789  root          SW<  [ixp400_eth]
  791  root          SW<  [ixp400_eth]
  804  root          SWN  [jffs2_gcd_mtd3]
  872  root          S    /usr/sbin/inetd
  883  root       5276  S    /bin/httpd -f /etc/apache/httpd.conf -k start

```

```

911 root      SW [pccardd]
913 root      SW [pccardd]
922 root      668 S  /sbin/cardmgr
1003 bin       432 S  /sbin/portmap
1009 root     1368 S /bin/sh -login
1015 root     1608 S /usr/sbin/snmpd -Lf /dev/null -c /etc/snmp/snmpd.conf
1026 root      672 S  /usr/sbin/rpc.nfsd
1028 root      648 S  /usr/sbin/rpc.mountd
1037 root     1392 S /usr/sbin/sshd -f /etc/ssh/etc/ssh_config
1045 root      320 S  /bin/reportip
1046 root      428 S  /bin/massupfirm
1047 root      444 S  /sbin/getty 115200 ttyS1
1068 root      428 S  /bin/massupfirm
1069 root      428 S  /bin/massupfirm
1070 nobody    5296 S /bin/httpd -f /etc/apache/httpd.conf -k start
1071 nobody    5296 S /bin/httpd -f /etc/apache/httpd.conf -k start
1072 nobody    5296 S /bin/httpd -f /etc/apache/httpd.conf -k start
1073 nobody    5296 S /bin/httpd -f /etc/apache/httpd.conf -k start
1074 nobody    5296 S /bin/httpd -f /etc/apache/httpd.conf -k start
20292 root     1804 S  sshd: root@tty0
20309 root     1364 S  -bash
20447 root      SW [rpciod]
2673 root      276 S  klogd
2681 root      268 S  syslogd
2799 root      SWN [jffs2_gcd_mtd2]
28768 root      608 R  ps -ef
root@Moxa:/ect# █

```

To run a private daemon, you can edit the file `rc.local`, as follows:

```
#cd /etc/rc.d
#vi rc.local
```

```

192.168.3.127 - PuTTY
root@Moxa:~# cd /etc/rc.d
root@Moxa:/etc/rc.d# vi rc.local █

```

Next, use `vi` editor to open your application program. We use the example program `tcps2-release`, and allow it to run in the background.

```

192.168.3.127 - PuTTY
# !/bin/sh
# Add you want to run daemon
/root/tcps2-release &~

```

After rebooting the system, the following daemons will be enabled.

```

192.168.3.127 - PuTTY
root@Moxa:~# ps -ef
PID  Uid    VmSize  Stat  Command
  1  root      492 S    init [3]
  2  root      SW<    [ksoftirqd/0]
  3  root      SW<    [desched/0]
  4  root      SW<    [events/0]
  5  root      SW<    [khelper]
 10  root      SW<    [kthread]
 13  root      SW<    [kblockd/0]
 86  root      SW     [pdflush]
 87  root      SW     [pdflush]
 89  root      SW<    [aio/0]
 43  root      SW     [khubd]
 88  root      SW     [kswapd0]
605  root      SW     [swapper]
606  root      SW     [swapper]
607  root      SW     [swapper]
645  root      SW     [mtdblockd]

```



```

783 root          DW< [EthDB event thr]
786 root          SW< [ixp400_eth]
789 root          SW< [ixp400_eth]
791 root          SW< [ixp400_eth]
804 root          SWN [jffs2_gcd_mtd3]
872 root          572 S /usr/sbin/inetd
883 root          5276 S /bin/httpd -f /etc/apache/httpd.conf -k start
911 root          SW [pccardd]
913 root          SW [pccardd]
922 root          668 S /sbin/cardmgr
1003 bin          432 S /sbin/portmap
1009 root         1368 S /bin/sh -login
1015 root         1608 S /usr/sbin/snmpd -Lf /dev/null -c /etc/snmp/snmpd.conf
1026 root         672 S /usr/sbin/rpc.nfsd
1028 root         648 S /usr/sbin/rpc.mountd
1037 root         1392 S /usr/sbin/sshd -f /etc/ssh/etc/ssh_config
1045 root         320 S /bin/reportip
1046 root         428 S /bin/massupfirm
1047 root         444 S /sbin/getty 115200 ttyS1
1068 root         428 S /bin/massupfirm
1069 root         428 S /bin/massupfirm
1070 nobody       5296 S /bin/httpd -f /etc/apache/httpd.conf -k start
1071 nobody       5296 S /bin/httpd -f /etc/apache/httpd.conf -k start
1072 nobody       5296 S /bin/httpd -f /etc/apache/httpd.conf -k start
1073 nobody       5296 S /bin/httpd -f /etc/apache/httpd.conf -k start
1074 nobody       5296 S /bin/httpd -f /etc/apache/httpd.conf -k start
20292 root        1804 S sshd: root@tty0
20309 root        1364 S -bash
20447 root        SW [rpciod]
2673 root        276 S klogd
2681 root        268 S syslogd
2799 root        SWN [jffs2_gcd_mtd2]
28768 root        608 R ps -ef
root@Moxa:~# █

```

Setting the Run-level

In this section, we outline the steps you should take to set the Linux run-level and execute requests. Use the following command to enable or disable settings:

```

192.168.3.127 - PuTTY
root@Moxa:/etc/rc.d/rc3.d# ls
S20snmpd S55ssh S99showreadyled
S25nfs-server S99rmnologin
root@Moxa:/etc/rc.d/rc3.d# █

```

```
#cd /etc/rc.d/init.d
```

Edit a shell script to execute `/root/tcps2-release` and save to `tcps2` as an example.

```
#cd /etc/rc.d/rc3.d
#ln -s /etc/rc.d/init.d/tcps2 S60tcps2
```

SxxRUNFILE stands for

S: start the run file while linux boots up.

xx: a number between 00-99. The smaller number has a higher priority.

RUNFILE: the file name.

```

192.168.3.127 - PuTTY
root@Moxa:/etc/rc.d/rc3.d# ls
S20snmpd S55ssh S99showreadyled
S25nfs-server S99rmnologin
root@Moxa:/etc/rc.d/rc3.d# ln -s /root/tcps2-release S60tcps2
root@Moxa:/etc/rc.d/rc3.d# ls
S20snmpd S55ssh S99showreadyled

```

```
S25nfs-server S99rnmologin S60tcps2
root@Moxa:/etc/rc.d/rc3.d# █
```

KxxRUNFILE stands for

K: start the run file while Linux shuts down or halts.

xx: a number from 00-99. Smaller numbers have a higher priority.

RUNFILE: is the file name.

For removing the daemon, you can remove the run file from `/etc/rc.d/rc3.d` by using the following command:

```
#rm -f /etc/rc.d/rc3.d/S60tcps2
```

Adjusting the System Time

Setting the Time Manually

The DA-661/662/663 has two time settings. One is the system time, and the other is the RTC (Real-time Clock) time kept by the DA-661/662/663 hardware. Use the `#date` command to query the current system time or set a new system time. Use `#hwclock` to query the current RTC time or set a new RTC time.

Use the following command to query the system time:

```
#date
```

Use the following command to query the RTC time:

```
#hwclock
```

Use the following command to set the system time:

```
#date MMDDhhmmYYYY
```

MM = Month

DD = Date

hhmm = hour and minute

YYYY = Year

Use the following command to set the RTC time:

```
#hwclock -w
```

Write current system time to RTC

The following figure illustrates how to update the system time and set the RTC time.

```
192.168.3.127 - PuTTY
root@Moxa:~# date
Fri Jun 23 23:30:31 CST 2000
root@Moxa:~# hwclock
Fri Jun 23 23:30:35 2000 -0.557748 seconds
root@Moxa:~# date 070910002006
Sun Jul 9 10:00:00 CST 2006
root@Moxa:~# hwclock -w
root@Moxa:~# date ; hwclock
Sun Jul 9 10:01:07 CST 2006
Sun Jul 9 10:01:08 2006 -0.933547 seconds
root@Moxa:~# █
```

NTP Client

The DA-661/662/663 has a built-in NTP (Network Time Protocol) client that is used to initialize a time request to a remote NTP server. Use `#ntpdate <this client utility>` to update the system time.

```
#ntpdate time.stdtime.gov.tw
#hwclock -w
```

Visit <http://www.ntp.org> for more information about NTP and NTP server addresses.

```
10.120.53.100 - PuTTY
root@Moxa:~# date ; hwclock
Sat Jan 1 00:00:36 CST 2000
Sat Jan 1 00:00:37 2000 -0.772941 seconds
root@Moxa:~# ntpdate time.stdtime.gov.tw
 9 Dec 10:58:53 ntpdate[207]: step time server 220.130.158.52 offset 155905087.984256
sec
root@Moxa:~# hwclock -w
root@Moxa:~# date ; hwclock
Thu Dec 9 10:59:11 CST 2004
Thu Dec 9 10:59:12 2004 -0.844076 seconds
root@Moxa:~# █
```

NOTE Before using the NTP client utility, check your IP and DNS settings to make sure that an Internet connection is available. Refer to Chapter 2 for instructions on how to configure the Ethernet interface, and see Chapter 4 for DNS setting information.

Updating the Time Automatically

In this subsection, we show how to use a shell script to update the time automatically.

Example shell script to update the system time periodically

```
#!/bin/sh
ntpdate time.nist.gov # You can use the time server's ip address or domain
                      # name directly. If you use domain name, you must
                      # enable the domain client on the system by updating
                      # /etc/resolv.conf file.

hwclock -systohc
sleep 100 # Updates every 100 seconds. The min. time is 100 seconds. Change
          # 100 to a larger number to update RTC less often.
```

Save the shell script using any file name (e.g., **fixtime**).

How to run the shell script automatically when the kernel boots up

Copy the example shell script **fixtime** to directory `/etc/init.d`, and then use `chmod 755 fixtime` to change the shell script mode. Next, use vi editor to edit the file `/etc/inittab`. Add the following line to the bottom of the file:

```
ntp : 2345 : respawn : /etc/init.d/fixtime
```

Use the command `#init q` to re-init the kernel.

Cron—Daemon for Executing Scheduled Commands

Start Cron from the directory `/etc/rc.d/rc.local`. It will return immediately, so you don't need to start it with `&` to run in the background.

The Cron daemon will search `/etc/cron.d/crontab` for crontab files, which are named after accounts in `/etc/passwd`.

Cron wakes up every minute, and checks each command to see if it should be run in the current minute.

Modify the file `/etc/cron.d/crontab` to set up your scheduled applications. Crontab files have the following format:

mm	h	dom	mon	dow	user	command
min	hour	date	month	week	user	command
0-59	0-23	1-31	1-12	0-6 (0 is Sunday)		

The following example demonstrates how to use Cron.

How to use cron to update the system time and RTC time every day at 8:00.

STEP1: Write a shell script named `fixtime.sh` and save it to `/home/`.

```
#!/bin/sh
ntpdate time.nist.gov
hwclock --systohc
exit 0
```

STEP2: Change mode of `fixtime.sh`

```
#chmod 755 fixtime.sh
```

STEP3: Modify `/etc/cron.d/crontab` file to run `fixtime.sh` at 8:00 every day.

Add the following line to the end of crontab:

```
* 8 * * * root/home/fixtime.sh
```

STEP4: Enable the cron daemon manually.

```
#/etc/init.d/cron start
```

STEP5: Enable cron when the system boots up.

Add the following line in the file `/etc/init.d/rc.local`

```
#/etc/init.d/cron start
```

Connecting Peripherals

USB Mass Storage

The DA-661/662/663 supports PNP (plug-n-play), and hot pluggability for connecting USB mass storage devices. The DA-661/662/663 has a built-in auto mount utility that eases the mounting procedure. The first USB mass storage device to be connected will be mounted automatically by **mount** to `/mnt/sda`, and the second device will be mounted automatically to `/mnt/sdb`. The DA-661/662/663 will be un-mounted automatically with the **umount** command when the device is disconnected.

**ATTENTION**

Remember to type the **#sync** command before you disconnect the USB mass storage device. If you don't issue the command, you may lose some data.

Remember to exit the **/mnt/sda** or **/mnt/sdb** directory when you disconnect the USB mass storage device. If you stay in **/mnt/sda** or **/mnt/sda**, the auto un-mount process will fail. If that happens, type **#umount /mnt/sda** to un-mount the USB device manually.

The DA-661/662/663 only supports certain types of flash disk USB mass storage devices. The following USB flash disks are supported:

- San Sandisk Cruzer mini 128MB
- Sandisk Cruzer Crossfire 1GB
- Sandisk Cruzer mini 2GB
- Intel Flash Memory 128MB
- Abocom 128MB
- PQI 256MB
- Transcend JetFlash 1G
- Transcend JetFlash 128MB
- Transcend JetFlash V30 1GB
- Transcend JetFlash V30 2GB
- ADATA My Flash 1G
- ADATA My Flash 2G

Some USB flash disks and hard disks may not be compatible with the DA-661/662/663. Check compatibility issues before you purchase a USB device to connect to the DA-661/662/663.

CF Mass Storage

The DA-661/662/663 supports PNP and hot pluggability for connecting a CF mass storage device. The DA-661/662/663 has a built-in auto mount utility that eases the mount procedure. The CF mass storage device will be mounted automatically by the **mount** command to **/mnt/hda**. The DA-661/662/663 will be un-mounted automatically by **umount** when you disconnect it.

**ATTENTION**

Remember to type the **#sync** command before you unplug the CF mass storage device. If you don't issue the command, you may lose some data.

Remember to exit the **/mnt/hda** directory when you disconnect the CF mass storage device. If you stay in **/mnt/hda**, the auto un-mount process will fail. If that happens, type **#umount /mnt/hda** to un-mount the CF device manually.

The DA-661/662/663 only supports certain types of CF mass storage device. The following devices are supported:

- Transcend CompactFlash 45x 2GB
- Transcend CompactFlash 80x 4GB
- SanDisk CompactFlash Ultra II 1GB
- PRETEC Compactflash 128M
- PRETEC Compactflash 256M
- ADATA Compactflash 120X 4G

Some CF mass storage devices and hard disks may not be compatible with the DA-661/662/663. Check compatibility issues before you purchase a CF mass storage to connect to the DA-661/662/663.

Managing Communications

In this chapter, we explain how to configure the DA-661/662/663's various communication functions.

The following topics are covered in this chapter:

- Telnet / FTP**
- DNS**
- Web Service—Apache**
- IPTABLES**
- NAT**
 - NAT Example
 - Enabling NAT at Bootup
- Dial-up Service—PPP**
- PPPoE**
- NFS (Network File System)**
 - Setting up the DA-661/662/663 as an NFS Server
 - Setting up the DA-661/662/663 as an NFS Client
- Mail**
- SNMP**
- OpenVPN**

Telnet / FTP

In addition to supporting Telnet client/server and FTP client/server, the DA-661/662/663 also supports SSH and sftp client/server. To enable or disable the Telnet/ftp server, you first need to edit the file `/etc/inetd.conf`.

Enabling the Telnet/ftp server

The following example shows the default content of the file `/etc/inetd.conf`. The default is to enable the Telnet/ftp server:

```
discard dgram udp wait root /bin/discard
discard stream tcp nowait root /bin/discard
telnet stream tcp nowait root /bin/telnetd
ftp stream tcp nowait root /bin/ftpd -l
```

Disabling the Telnet/ftp server

Disable the daemon by typing '#' in front of the first character of the row to comment out the line.

DNS

The DA-661/662/663 support DNS client (but not DNS server). To set up DNS client, you need to edit three configuration files: `/etc/hosts`, `/etc/resolv.conf`, and `/etc/nsswitch.conf`.

`/etc/hosts`

This is the first file that the Linux system reads to resolve the host name and IP address.

`/etc/resolv.conf`

This is the most important file that you need to edit when using DNS for the other programs. For example, before using `#ntpdate time.nist.gov` to update the system time, you will need to add the DNS server address to the file. Ask your network administrator which DNS server address you should use. The DNS server's IP address is specified with the "nameserver" command. For example, add the following line to `/etc/resolv.conf` if the DNS server's IP address is 168.95.1.1:

```
nameserver 168.95.1.1
```

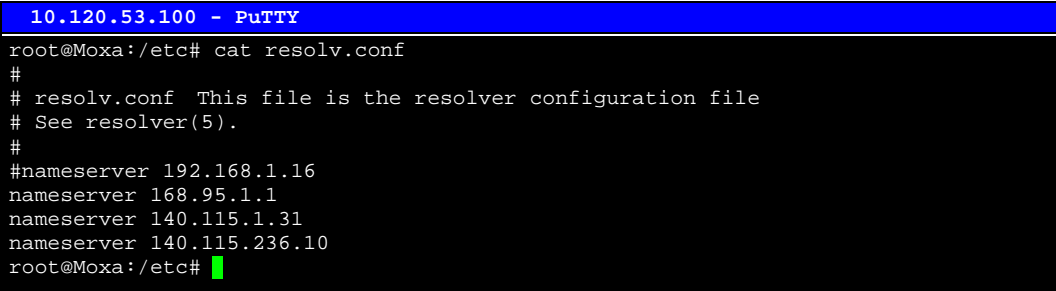

```
10.120.53.100 - PuTTY
root@Moxa:/etc# cat resolv.conf
#
# resolv.conf This file is the resolver configuration file
# See resolver(5).
#
#nameserver 192.168.1.16
nameserver 168.95.1.1
nameserver 140.115.1.31
nameserver 140.115.236.10
root@Moxa:/etc# █
```

`/etc/nsswitch.conf`

This file defines the sequence to resolve the IP address by using `/etc/hosts` file or `/etc/resolv.conf`.

Web Service—Apache

The Apache web server's main configuration file is `/etc/apache/conf/httpd.conf`, with the default homepage located at `/usr/www/html/index.html`. Save your own homepage to the following directory:

```
/usr/www/html/
```

Save your CGI page to the following directory:

```
/usr/www/cgi-bin/
```

Before you modify the homepage, use a browser (such as Microsoft Internet Explorer or Mozilla Firefox) from your PC to test if the Apache Web Server is working. Type the LAN1 IP address in the browser's address box to open the homepage. E.g., if the default IP address is still active, type `http://host-ip-address` in address box.

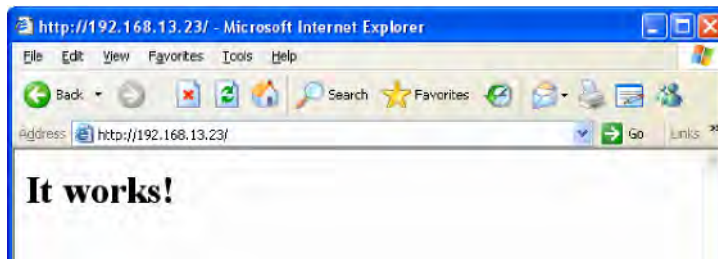

To open the default CGI page, type `http://host-ip-address/cgi-bin/printenv` in your browser's address box.

```
DOCUMENT_ROOT="/home/httpd/html/"
GATEWAY_INTERFACE="CGI/1.1"
HTTP_ACCEPT="text/xml,application/xml,application/xhtml+xml,text/html;q=0.9,text/plain;q=0.8,image/png,*/*;q=0.5"
HTTP_ACCEPT_CHARSET="Big5,utf-8;q=0.7,*;q=0.7"
HTTP_ACCEPT_ENCODING="gzip,deflate"
HTTP_ACCEPT_LANGUAGE="zh-tw,en-us;q=0.7,en;q=0.3"
HTTP_CONNECTION="keep-alive"
HTTP_HOST="192.168.30.11"
HTTP_KEEP_ALIVE="300"
HTTP_USER_AGENT="Mozilla/5.0 (Windows; U; Windows NT 5.1; zh-TW; rv:1.8.1.11) Gecko/20071127 Firefox/2.0.0.11"
PATH="/sbin:/bin:/usr/sbin:/usr/bin"
QUERY_STRING=""
REMOTE_ADDR="192.168.30.36"
REMOTE_PORT="1572"
REQUEST_METHOD="GET"
REQUEST_URI="/cgi-bin/printenv"
SCRIPT_FILENAME="/home/httpd/cgi-bin/printenv"
SCRIPT_NAME="/cgi-bin/printenv"
SERVER_ADDR="192.168.30.11"
SERVER_ADMIN="you@example.com"
SERVER_NAME="192.168.30.11"
SERVER_PORT="80"
SERVER_PROTOCOL="HTTP/1.1"
SERVER_SIGNATURE=""
SERVER_SOFTWARE="Apache/2.2.2 (Unix) mod_ssl/2.2.2 OpenSSL/0.9.7e PHP/5.1.4"
```

To open the default CGI test script report page, type `http://host-ip-address/cgi-bin/test-cgi` in your browser's address box.

```

CGI/1.0 test script report:

argc is 0. argv is .

SERVER_SOFTWARE = Apache/2.2.2 (Unix) mod_ssl/2.2.2 OpenSSL/0.9.7e PHP/5.1.4
SERVER_NAME = 192.168.30.11
GATEWAY_INTERFACE = CGI/1.1
SERVER_PROTOCOL = HTTP/1.1
SERVER_PORT = 80
REQUEST_METHOD = GET
HTTP_ACCEPT = text/xml,application/xml,application/xhtml+xml,text/html;q=0.9,text/plain;q=0.8,image/png,*/*;q=0.5
PATH_INFO =
PATH_TRANSLATED =
SCRIPT_NAME = /cgi-bin/test-cgi
QUERY_STRING =
REMOTE_HOST =
REMOTE_ADDR = 192.168.30.36
REMOTE_USER =
AUTH_TYPE =
CONTENT_TYPE =
CONTENT_LENGTH =

```

NOTE The CGI function is enabled by default. If you want to disable the function, modify the file `/etc/apache/conf/httpd.conf`. When you develop your own CGI application, make sure your CGI file is executable.

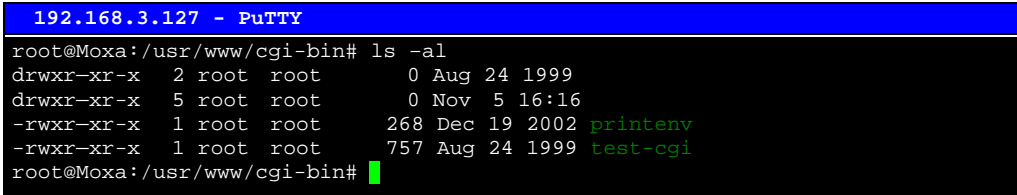

```

192.168.3.127 - PuTTY
root@Moxa:/usr/www/cgi-bin# ls -al
drwxr-xr-x  2 root root    0 Aug 24 1999
drwxr-xr-x  5 root root    0 Nov  5 16:16
-rwxr-xr-x  1 root root  268 Dec 19 2002 printenv
-rwxr-xr-x  1 root root  757 Aug 24 1999 test-cgi
root@Moxa:/usr/www/cgi-bin#

```

IPTABLES

IPTABLES is an administrative tool for setting up, maintaining, and inspecting the Linux kernel's IP packet filter rule tables. Several different tables are defined, with each table containing built-in chains and user-defined chains.

Each chain is a list of rules that apply to a certain type of packet. Each rule specifies what to do with a matching packet. A rule (such as a jump to a user-defined chain in the same table) is called a “target”.

DA-661/662/663 supports 3 types of IPTABLES table: **Filter** tables, **NAT** tables, and **Mangle** tables:

A. Filter Table—includes three chains:

- INPUT chain
- OUTPUT chain
- FORWARD chain

B. NAT Table—includes three chains:

- PREROUTING chain—transfers the destination IP address (DNAT)
- POSTROUTING chain—works after the routing process and before the Ethernet device process to transfer the source IP address (SNAT)
- OUTPUT chain—produces local packets

sub-tables

- Source NAT (SNAT)—changes the first source packet IP address
- Destination NAT (DNAT)—changes the first destination packet IP address

MASQUERADE—a special form for SNAT. If one host can connect to internet, then other computers that connect to this host can connect to the Internet when it the computer does not have an actual IP address.

REDIRECT—a special form of DNAT that re-sends packets to a local host independent of the destination IP address.

C. Mangle Table—includes two chains

PREROUTING chain—pre-processes packets before the routing process.

OUTPUT chain—processes packets after the routing process.

It has three extensions—TTL, MARK, TOS.

The following figure shows the IPTABLES hierarchy.

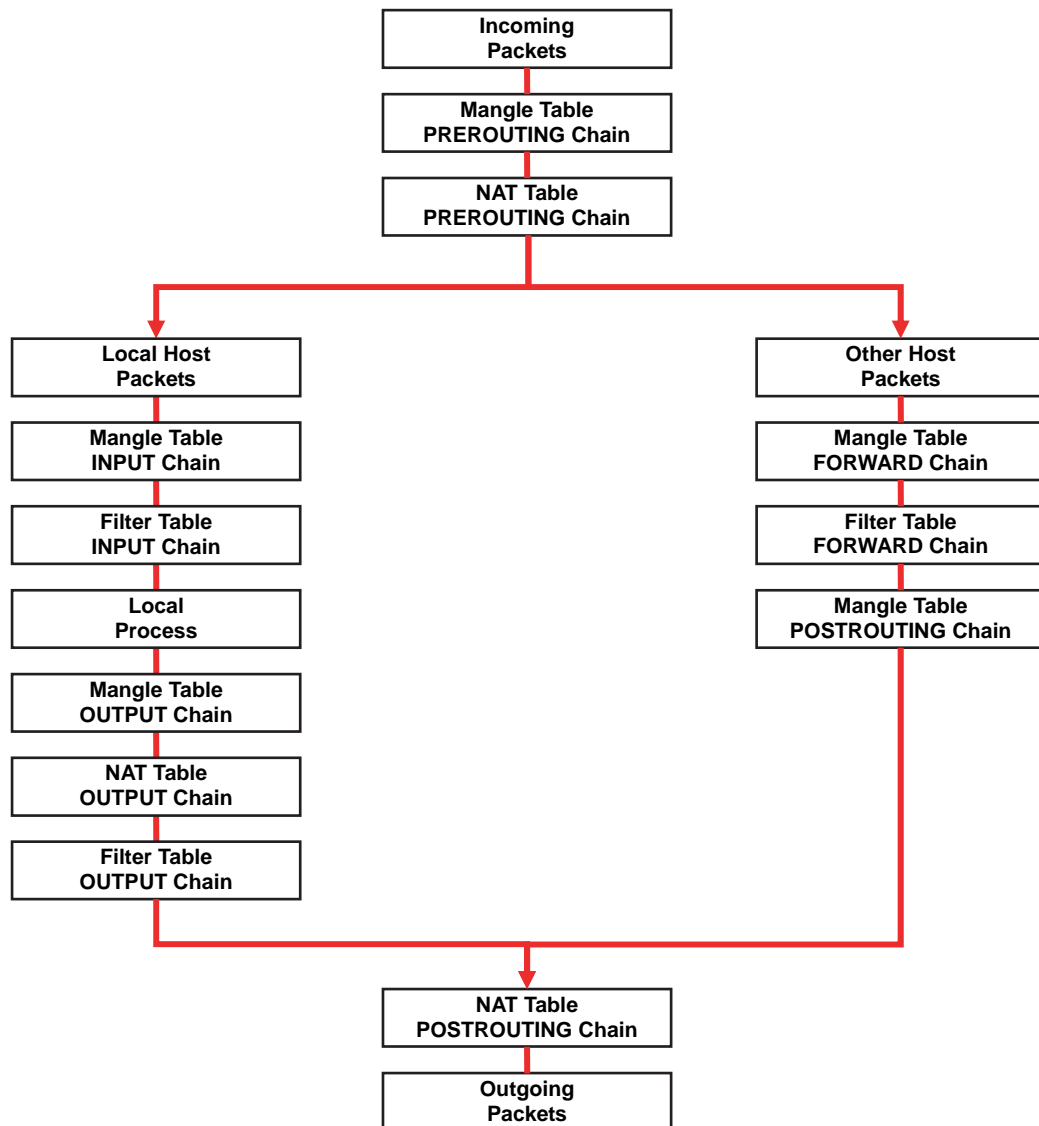

The DA-661/662/663 support the following sub-modules. Be sure to use the module that matches your application.

ip_conntrack	ipt_MARK	ipt_ah	ipt_state
ip_conntrack_ftp	ipt_MASQUERADE	ipt_esp	ipt_tcpmss
ipt_conntrack_irc	ipt_LOG	ipt_length	ipt_tos
ip_nat_ftp	ipt_REDIRECT	ipt_limit	ipt_ttl
ip_nat_irc	ipt_REJECT	ipt_mac	iptable_mangle
ip_nat_snmp_basic	ipt_TCPMSS	ipt_mark	iptable_nat
ip_queue	ipt_TOS	ipt_multiport	iptable_filter
ipt_LOG	ipt_ULOG	ipt_owner	ip_tables

NOTE The DA-661/662/663 do NOT support IPV6 and ipchains.

The basic syntax to enable and load an IPTABLES module is as follows:

```
#lsmod
#modprobe ip_tables
#modprobe iptable_filter
```

Use lsmod to check if the ip_tables module has already been loaded in the DA-661/662/663. Use **modprobe** to insert and enable the module.

Use the following command to load the modules (**iptable_filter**, **iptable_mangle**, **iptable_nat**):

```
#modprobe iptable_filter
```

NOTE IPTABLES plays the role of packet filtering or NAT. Take care when setting up the IPTABLES rules. If the rules are not correct, remote hosts that connect via a LAN or PPP may be denied access. We recommend using the Serial Console to set up the IPTABLES.

Click on the following links for more information about iptables.

<http://www.linuxguruz.com/iptables/>

<http://www.netfilter.org/documentation/HOWTO//packet-filtering-HOWTO.html>

Since the IPTABLES command is very complex, to illustrate the IPTABLES syntax we have divided our discussion of the various rules into three categories: **Observe and erase chain rules**, **Define policy rules**, and **Append or delete rules**.

Observe and erase chain rules

Usage:

```
# iptables [-t tables] [-L] [-n]
```

-t tables: Table to manipulate (default: 'filter'); example: nat or filter.

-L [chain]: List List all rules in selected chains. If no chain is selected, all chains are listed.

-n: Numeric output of addresses and ports.

```
# iptables [-t tables] [-FXZ]
```

-F: Flush the selected chain (all the chains in the table if none is listed).

-X: Delete the specified user-defined chain.

-Z: Set the packet and byte counters in all chains to zero.

Examples:

```
# iptables -L -n
```

In this example, since we do not use the -t parameter, the system uses the default 'filter' table. Three chains are included: INPUT, OUTPUT, and FORWARD. INPUT chains are accepted automatically, and all connections are accepted without being filtered.

```
#iptables -F
```

```
#iptables -X
```

```
#iptables -Z
```

Define policy for chain rules

Usage:

```
# iptables [-t tables] [-P] [INPUT, OUTPUT, FORWARD, PREROUTING, OUTPUT, POSTROUTING]  
[ACCEPT, DROP]
```

-P: Set the policy for the chain to the given target.

INPUT: For packets coming into the DA-661/662/663.

OUTPUT: For locally-generated packets.

FORWARD: For packets routed out through the DA-661/662/663.

PREROUTING: To alter packets as soon as they come in.

POSTROUTING: To alter packets as they are about to be sent out.

Examples:

```
#iptables -P INPUT DROP
```

```
#iptables -P OUTPUT ACCEPT
```

```
#iptables -P FORWARD ACCEPT
```

```
#iptables -t nat -P PREROUTING ACCEPT
```

```
#iptables -t nat -P OUTPUT ACCEPT
```

```
#iptables -t nat -P POSTROUTING ACCEPT
```

In this example, the policy accepts outgoing packets and denies incoming packets.

Append or delete rules

Usage:

```
# iptables [-t table] [-AI] [INPUT, OUTPUT, FORWARD] [-i interface] [-p tcp, udp, icmp,
all] [-s IP/network] [--sport ports] [-d IP/network] [--dport ports] -j [ACCEPT. DROP]
```

- A: Append one or more rules to the end of the selected chain.
- I: Insert one or more rules in the selected chain as the given rule number.
- i: Name of an interface via which a packet is going to be received.
- o: Name of an interface via which a packet is going to be sent.
- p: The protocol of the rule or of the packet to check.
- s: Source address (network name, host name, network IP address, or plain IP address).
- sport: Source port number.
- d: Destination address.
- dport: Destination port number.
- j: Jump target. Specifies the target of the rules; i.e., how to handle matched packets. For example, ACCEPT the packet, DROP the packet, or LOG the packet.

Examples:

Example 1: Accept all packets from lo interface.

```
# iptables -A INPUT -i lo -j ACCEPT
```

Example 2: Accept TCP packets from 192.168.0.1.

```
# iptables -A INPUT -i eth0 -p tcp -s 192.168.0.1 -j ACCEPT
```

Example 3: Accept TCP packets from Class C network 192.168.1.0/24.

```
# iptables -A INPUT -i eth0 -p tcp -s 192.168.1.0/24 -j ACCEPT
```

Example 4: Drop TCP packets from 192.168.1.25.

```
# iptables -A INPUT -i eth0 -p tcp -s 192.168.1.25 -j DROP
```

Example 5: Drop TCP packets addressed for port 21.

```
# iptables -A INPUT -i eth0 -p tcp --dport 21 -j DROP
```

Example 6: Accept TCP packets from 192.168.0.24 to DA-661/662/663's port 137, 138, 139

```
# iptables -A INPUT -i eth0 -p tcp -s 192.168.0.24 --dport 137:139 -j ACCEPT
```

Example 7: Log TCP packets that visit DA-661/662/663's port 25

```
# iptables -A INPUT -i eth0 -p tcp --dport 25 -j LOG
```

Example 8: Drop all packets from MAC address 01:02:03:04:05:06

```
# iptables -A INPUT -i eth0 -p all -m mac --mac-source 01:02:03:04:05:06 -j DROP
```

NAT

NAT (Network Address Translation) protocol translates IP addresses used on one network to different IP addresses used on another network. One network is designated the inside network and the other is the outside network. Typically, the DA-661/662/663 connects several devices on a network and maps local inside network addresses to one or more global outside IP addresses, and un-maps the global IP addresses on incoming packets back into local IP addresses.

NOTE	Click on the following link for more information about iptables and NAT: http://www.netfilter.org/documentation/HOWTO/NAT-HOWTO.html
-------------	---

NAT Example

The IP address of LAN1 is changed to 192.168.3.127 (you will need to load the module `ipt_MASQUERADE`):

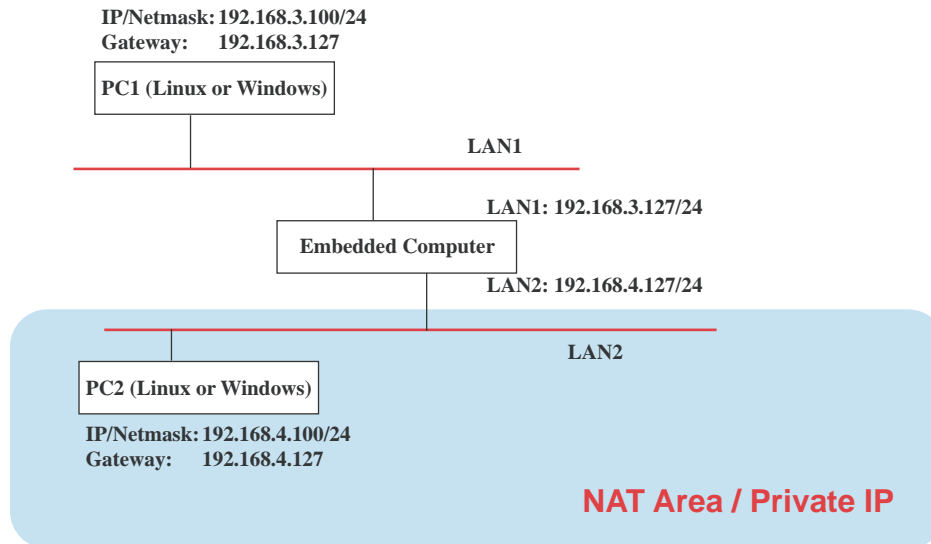

1. `#echo 1 > /proc/sys/net/ipv4/ip_forward`
2. `#modprobe ip_tables`
3. `#modprobe ip_conntrack`
4. `#modprobe iptable_nat`
5. `#modprobe ipt_MASQUERADE`
6. `#iptables -t nat -A POSTROUTING -o eth0 -j MASQUERADE`

Enabling NAT at Bootup

In the most real world situations, you will want to use a simple shell script to enable NAT when the DA-661/662/663 boots up. The following script is an example.

```
#!/bin/bash
# If you put this shell script in the /home/nat.sh
# Remember to chmod 744 /home/nat.sh
# Edit the rc.local file to make this shell startup automatically.
# vi /etc/rc.d/rc.local
# Add a line in the end of rc.local /home/nat.sh
EXIF='eth0' #This is an external interface for setting up a valid IP address.
EXNET='192.168.4.0/24' #This is an internal network address.
# Step 1. Insert modules.
# Here 2> /dev/null means the standard error messages will be dump to null device.
modprobe ip_tables 2> /dev/null
modprobe ip_conntrack 2> /dev/null
modprobe ip_conntrack_ftp 2> /dev/null
modprobe ip_conntrack_irc 2> /dev/null
modprobe iptable_nat 2> /dev/null
modprobe ip_nat_ftp 2> /dev/null
modprobe ip_nat_irc 2> /dev/null
# Step 2. Define variables, enable routing and erase default rules.
PATH=/bin:/sbin:/usr/bin:/usr/sbin:/usr/local/bin:/usr/local/sbin
export PATH
echo "1" > /proc/sys/net/ipv4/ip_forward
```

```

/sbin/iptables -F
/sbin/iptables -X
/sbin/iptables -Z
/sbin/iptables -F -t nat
/sbin/iptables -X -t nat
/sbin/iptables -Z -t nat
/sbin/iptables -P INPUT ACCEPT
/sbin/iptables -P OUTPUT ACCEPT
/sbin/iptables -P FORWARD ACCEPT
/sbin/iptables -t nat -P PREROUTING ACCEPT
/sbin/iptables -t nat -P POSTROUTING ACCEPT
/sbin/iptables -t nat -P OUTPUT ACCEPT
# Step 3. Enable IP masquerade.

```

Dial-up Service—PPP

PPP (Point to Point Protocol) is used to run IP (Internet Protocol) and other network protocols over a serial link. PPP can be used for direct serial connections (using a null-modem cable) over a Telnet link, and links established using a modem over a telephone line.

Modem / PPP access is almost identical to connecting directly to a network through the DA-661/662/663's Ethernet port. Since PPP is a peer-to-peer system, the DA-661/662/663 can also use PPP to link two networks (or a local network to the Internet) to create a Wide Area Network (WAN).

NOTE Click on the following links for more information about ppp:

<http://tldp.org/HOWTO/PPP-HOWTO/index.html>

<http://axion.physics.ubc.ca/ppp-linux.html>

The pppd daemon is used to connect to a PPP server from a Linux system. For detailed information about pppd see the man page.

Example 1: Connecting to a PPP server over a simple dial-up connection

The following command is used to connect to a PPP server by modem. Use this command for old ppp servers that prompt for a login name (replace *username* with the correct name) and password (replace *password* with the correct password). Note that *debug* and *defaultroute* 192.1.1.17 are optional.

```
#pppd connect 'chat -v " " ATDT5551212 CONNECT" " ogin: username word: password'
/dev/ttyM0 115200 debug crtscts modem defaultroute
```

If the PPP server does not prompt for the username and password, the command should be entered as follows. Replace *username* with the correct username and replace *password* with the correct password.

```
#pppd connect 'chat -v " " ATDT5551212 CONNECT" ""user username password password
/dev/ttyM0 115200 crtscts modem
```

The pppd options are described below:

```
connect 'chat etc...'
```

This option gives the command to contact the PPP server. The 'chat' program is used to dial a remote computer. The entire command is enclosed in single quotes because pppd expects a one-word argument for the 'connect' option. The options for 'chat' are given below:

```
-v
```

verbose mode; log what we do to syslog

```
" "
```

Double quotes—don't wait for a prompt, but instead do ... (note that you must include a space after the second quotation mark)

```
ATDT5551212
```

Dial the modem, and then ...

```
CONNECT
```

Wait for an answer.

```
" "
```

Send a return (null text followed by the usual return)

```
ogin: username word: password
```

Log in with username and password.

Refer to the chat man page, chat.8, for more information about the chat utility.

```
/dev/
```

Specify the callout serial port.

```
115200
```

The baudrate.

```
debug
```

Log status in syslog.

```
crtscts
```

Use hardware flow control between computer and modem (at 115200 this is a must).

```
modem
```

Indicates that this is a modem device; pppd will hang up the phone before and after making the call.

```
defaultroute
```

Once the PPP link is established, make it the default route; if you have a PPP link to the Internet, this is probably what you want.

```
192.1.1.17
```

This is a degenerate case of a general option of the form x.x.x.x:y.y.y.y. Here x.x.x.x is the local IP address and y.y.y.y is the IP address of the remote end of the PPP connection. If this option is not specified, or if just one side is specified, then x.x.x.x defaults to the IP address associated with the local machine's hostname (located in /etc/hosts), and y.y.y.y is determined by the remote machine.

Example 2: Connecting to a PPP server over a hard-wired link

If a username and password are not required, use the following command (note that noipdefault is optional):

```
#pppd connect `chat -v " " " " \ noipdefault /dev/ttyM0 19200 crtscts
```

If a username and password is required, use the following command (note that noipdefault is optional, and root is both the username and password):

```
#pppd connect `chat -v " " " " \ user root password root noipdefault /dev/ttyM0 19200 crtscts
```

How to check the connection

Once you've set up a PPP connection, there are some steps you can take to test the connection. First, type:

```
/sbin/ifconfig
```

(The folder **ifconfig** may be located elsewhere, depending on your distribution.) You should be able to see all the network interfaces that are UP. ppp0 should be one of them, and you should recognize the first IP address as your own, and the "P-t-P address" (or point-to-point address) the address of your server. Here's what it looks like on one machine:

```
lo      Link encap Local Loopback
        inet addr 127.0.0.1      Bcast 127.255.255.255    Mask 255.0.0.0
        UP LOOPBACK RUNNING    MTU 2000      Metric 1
        RX packets 0 errors 0 dropped 0 overrun 0

ppp0    Link encap Point-to-Point Protocol
        inet addr 192.76.32.3    P-t-P 129.67.1.165     Mask 255.255.255.0
        UP POINTOPOINT RUNNING  MTU 1500     Metric 1
        RX packets 33 errors 0 dropped 0 overrun 0
        TX packets 42 errors 0 dropped 0 overrun 0
```

Now, type:

```
ping z.z.z.z
```

where z.z.z.z is the address of your name server. This should work. Here's what the response could look like:

```
waddington:~$ping 129.67.1.165
PING 129.67.1.165 (129.67.1.165): 56 data bytes
64 bytes from 129.67.1.165: icmp_seq=0 ttl=225 time=268 ms
64 bytes from 129.67.1.165: icmp_seq=1 ttl=225 time=247 ms
64 bytes from 129.67.1.165: icmp_seq=2 ttl=225 time=266 ms
^C
--- 129.67.1.165 ping statistics ---
3 packets transmitted, 3 packets received, 0% packet loss
round-trip min/avg/max = 247/260/268 ms
waddington:~$
```

Try typing:

```
netstat -nr
```

This should show three routes, similar to the following:

```
Kernel routing table
```

Destination	iface	Gateway	Genmask	Flags	Metric	Ref	Use
129.67.1.165	ppp0	0.0.0.0	255.255.255.255	UH	0	0	6
127.0.0.0		0.0.0.0	255.0.0.0	U	0	0	0 lo
0.0.0.0	ppp0	129.67.1.165	0.0.0.0	UG	0	0	6298

If your output looks similar but doesn't have the destination 0.0.0.0 line (which refers to the default route used for connections), you may have run pppd without the 'defaultroute' option. At this point you can try using Telnet, ftp, or finger, bearing in mind that you'll have to use numeric IP addresses unless you've set up /etc/resolv.conf correctly.

Setting up a Machine for Incoming PPP Connections

This first example applies to using a modem, and requiring authorization with a username and password.

```
pppd/dev/ttyM0 115200 crtscts modem 192.168.16.1:192.168.16.2 login auth
```

You should also add the following line to the file `/etc/ppp/pap-secrets`:

```
* * "" *
```

The first star (*) lets everyone log in. The second star (*) lets every host connect. The pair of double quotation marks ("") is to use the file `/etc/passwd` to check the password. The last star (*) is to let any IP connect.

The following example does not check the username and password:

```
pppd/dev/ttyM0 115200 crtscts modem 192.168.16.1:192.168.16.2
```

PPPoE

1. Connect the DA-661/662/663's LAN port to an ADSL modem with a cross-over cable, HUB, or switch.
2. Login to the DA-661/662/663 as the root user.
3. Edit the file `/etc/ppp/chap-secrets` and add the following:

```
"username@hinet.net" * "password" *
```

```
192.168.3.127 - PuTTY
# Secrets for authentication using CHAP
# client      server secret          IP addresses
#
# PPPOE example, if you want to use it, you need to unmark it and modify it
"username@hinet.net" * "password" *
```

"username@hinet.net" is the username obtained from the ISP to log in to the ISP account. "password" is the corresponding password for the account.

4. Edit the file `/etc/ppp/pap-secrets` and add the following:

```
"username@hinet.net" * "password" *
```

```
192.168.3.127 - PuTTY
support hostname " * " -
stats hostname " * " -

# OUTBOUND connections
# ATTENTION: The definitions here can allow users to login without a
# package already provides this option; make sure you don't change that.

# INBOUND connections

# Every regular user can use PPP and has to use passwords from /etc/passwd
* hostname " * " *
"username@hinet.net" * "password" *

# PPPOE user example, if you want to use it, you need to unmark it and modify it
#"username@hinet.net" * "password" *

# UserIDs that cannot use PPP at all. Check your /etc/passwd and add any
# other accounts that should not be able to use pppd!
guest hostname " * " -
master hostname " * " -
root hostname " * " -
support hostname " * " -
stats hostname " * " -
```

“**username@hinet.net**” is the username obtained from the ISP to log in to the ISP account.
 “**password**” is the corresponding password for the account.

5. Edit the file `/etc/ppp/options` and add the following line:
plugin pppoe

```
192.168.3.127 - PuTTY
# Wait for up n milliseconds after the connect script finishes for a valid
# PPP packet from the peer. At the end of this time, or when a valid PPP
# packet is received from the peer, pppd will commence negotiation by
# sending its first LCP packet. The default value is 1000 (1 second).
# This wait period only applies if the connect or pty option is used.
#connect-delay <n>

# Load the pppoe plugin
plugin pppoe.so

# ---<End of File>---
```

6. Add one of two files: `/etc/ppp/options.eth0` or `/etc/ppp/options.eth1`. The choice depends on which LAN is connected to the ADSL modem. If you use LAN1 to connect to the ADSL modem, then add `/etc/ppp/options.eth0`. If you use LAN2 to connect to the ADSL modem, then add `/etc/ppp/options.eth1`. The file context is shown below:

```
192.168.3.127 - PuTTY
name username@hinet.net
mtu 1492
mru 1492
defaultroute
noipdefault
```

Type your username (the one you set in the `/etc/ppp/pap-secrets` and `/etc/ppp/chap-secrets` files) after the “name” option. You may add other options as desired.

7. Set up DNS
 If you are using DNS servers supplied by your ISP, edit the file `/etc/resolv.conf` by adding the following lines of code:

```
nameserver ip_addr_of_first_dns_server
nameserver ip_addr_of_second_dns_server
```

For example:

```
nameserver 168..95.1.1
nameserver 139.175.10.20
```

8. Use the following command to create a pppoe connection:
`pppd eth0`
 The eth0 is what is connected to the ADSL modem LAN port. The example above uses LAN1. To use LAN2, type:
`pppd eth1`
9. Type **ifconfig ppp0** to check if the connection is OK or has failed. If the connection is OK, you will see information about the ppp0 setting for the IP address. Use ping to test the IP.
10. If you want to disconnect it, use the kill command to kill the pppd process.

NFS (Network File System)

The Network File System (NFS) is used to mount a disk partition on a remote machine, as if it were on a local hard drive, allowing fast, seamless sharing of files across a network. NFS allows users to develop applications for the DA-661/662/663, without worrying about the amount of disk space that will be available. The DA-661/662/663 supports NFS protocol for both client and server.

NOTE Click on the following links for more information about NFS:
<http://www.tldp.org/HOWTO/NFS-HOWTO/index.html>
<http://nfs.sourceforge.net/nfs-howto/client.html>
<http://nfs.sourceforge.net/nfs-howto/server.html>

Setting up the DA-661/662/663 as an NFS Server

By default, DA-661/662/663 enables the service `/etc/init.d/nfs-user-server`. The service link file `S25nfs-user-server` is located in the directory `/rc.d/rc2.d-rc5.d`.

Edit the NFS server configuration file `/etc/exports` to set up the remote host (NFS client) list and access rights for a specific directory. The file formats are shown below:

```
#vi /etc/exports
```

File Format:

```
directory machine1(option11,option12) machine2(option21,option22)
```

directory

The directory that will be shared with the NFS Client.

machine1 and machine2

Client machines that will have access to the directory. A machine can be listed by its DNS address or IP address (e.g., `machine.company.com` or `192.168.0.8`).

optionxx

The option list for a machine describes the kind of access the machine will have. Important options are:

ro

Read only. This is the default.

rw

Readable and Writeable.

no_root_squash

If **no_root_squash** is selected, then the root on the client machine will have the same level of access to files on the system as the root on the server. This can have serious security implications, although it may be necessary if you want to do administrative work on the client machine that involves the exported directories. You should only specify this option when you have a good reason.

root_squash

Any file request made by the user root on the client machine is treated as if it is made by user nobody on the server. (Exactly which UID the request is mapped to depends on the UID of user "nobody" on the server, not the client.)

sync

Sync data to memory and flash disk.

async

The `async` option instructs the server to lie to the client, telling the client that all data has been written to the stable storage.

Example 1

```
/tmp *(rw,no_root_squash)
```

In this example, DA-661/662/663 shares the `/tmp` directory to everyone, gives everyone both read and write authority. The root user on the client machine will have the same level of access to files on the system as the root on the server.

Example 2

```
/home/public 192.168.0.0/24(rw) *(ro)
```

In this example, DA-661/662/663 shares the directory `/home/public` to a local network 192.168.0.0/24, with read and write authority. NFS clients can just read `/home/public`; they do not have write authority.

Example 3

```
/home/test 192.168.3.100(rw)
```

In this example, the DA-661/662/663 shares the directory `/home/test` to an NFS Client 192.168.3.100, with both read and write authority.

NOTE	After editing the NFS Server configuration file, remember to use the following command to restart and activate the NFS server.
-------------	--

```
/etc/init.d/nfs-user-server restart
```

Setting up the DA-661/662/663 as an NFS Client

The following procedure is used to mount a remote NFS Server.

1. Scan the NFS Server's shared directory.
2. Establish a mount point on the NFS Client site.
3. Mount the remote directory to a local directory.

Step 1:

```
#showmount -e HOST
```

showmount: Show the mount information for an NFS Server.
-e: Show the NFS Server's export list.
HOST: IP address or DNS address.

Steps 2 & 3:

```
#mkdir -p /home/nfs/public
```

```
#mount -t nfs NFS_Server(IP):/directory /mount/point
```

Example: `#mount -t nfs 192.168.3.100/home/public /home/nfs/public`

Mail

smtpclient is a minimal SMTP client that takes an email message body and passes it on to an SMTP server. It is suitable for applications that use email to send alert messages or important logs to a specific user.

NOTE Click on the following link for more information about smtpclient:
<http://www.engelschall.com/sw/smtpclient/>

To send an email message, use the 'smtpclient' utility, which uses SMTP protocol. Type **#smtpclient -help** to see the help message.

Example:

```
smtpclient -s test -f sender@company.com -S IP_address receiver@company.com
< mail-body-message
```

- s: The mail subject.
- f: Sender's mail address
- S: SMTP server IP address

The last mail address **receiver@company.com** is the receiver's e-mail address. **mail-body-message** is the mail content. The last line of the body of the message should contain ONLY the period '.' character.

You will need to add your hostname to the file **/etc/hosts**.

SNMP

The DA-661/662/663 has SNMP V1 (Simple Network Management Protocol) agent software built in. It supports RFC1317 RS-232 like groups and RFC 1213 MIB-II.

The following simple example allows you to use an SNMP browser on the host site to query the DA-661/662/663, which is the SNMP agent. The DA-661/662/663 will respond.

```
***** SNMP QUERY STARTED *****
1: sysDescr.0 (octet string) Linux Moxa 2.6.10_dev-ixdp42x-arm_xscale_be
2: sysObjectID.0 (object identifier) enterprises.2021.250.10
3: sysUpTime.0 (timeticks) 0 days 00h:41m:54s.47th (251447)
4: sysContact.0 (octet string) Root <root@localhost> (configure /etc/snmp/snmp.local.conf)
5: sysName.0 (octet string) Moxa
6: sysLocation.0 (octet string) Unknown (configure /etc/snmp/snmp.local.conf)
7: system.8.0 (timeticks) 0 days 00h:00m:00s.22th (22)
8: system.9.1.2.1 (object identifier) mib-2.31
9: system.9.1.2.2 (object identifier) internet.6.3.1
10: system.9.1.2.3 (object identifier) mib-2.49
11: system.9.1.2.4 (object identifier) ip
12: system.9.1.2.5 (object identifier) mib-2.50
13: system.9.1.2.6 (object identifier) internet.6.3.16.2.2.1
14: system.9.1.2.7 (object identifier) internet.6.3.10.3.1.1
15: system.9.1.2.8 (object identifier) internet.6.3.11.3.1.1
16: system.9.1.2.9 (object identifier) internet.6.3.15.2.1.1
17: system.9.1.3.1 (octet string) The MIB module to describe generic objects for network interface sub-layers
18: system.9.1.3.2 (octet string) The MIB module for SNMPv2 entities
19: system.9.1.3.3 (octet string) The MIB module for managing TCP implementations
20: system.9.1.3.4 (octet string) The MIB module for managing IP and ICMP implementations
21: system.9.1.3.5 (octet string) The MIB module for managing UDP implementations
22: system.9.1.3.6 (octet string) View-based Access Control Model for SNMP.
23: system.9.1.3.7 (octet string) The SNMP Management Architecture MIB.
24: system.9.1.3.8 (octet string) The MIB for Message Processing and Dispatching.
25: system.9.1.3.9 (octet string) The management information definitions for the SNMP User-based Security Model.
26: system.9.1.4.1 (timeticks) 0 days 00h:00m:00s.04th (4)
27: system.9.1.4.2 (timeticks) 0 days 00h:00m:00s.09th (9)
```

```

28: system.9.1.4.3 (timeticks) 0 days 00h:00m:00s.09th (9)
29: system.9.1.4.4 (timeticks) 0 days 00h:00m:00s.09th (9)
30: system.9.1.4.5 (timeticks) 0 days 00h:00m:00s.09th (9)
31: system.9.1.4.6 (timeticks) 0 days 00h:00m:00s.19th (19)
32: system.9.1.4.7 (timeticks) 0 days 00h:00m:00s.22th (22)
33: system.9.1.4.8 (timeticks) 0 days 00h:00m:00s.22th (22)
34: system.9.1.4.9 (timeticks) 0 days 00h:00m:00s.22th (22)
**** SNMP QUERY FINISHED ****
    
```

NOTE Click on the following links for more information about MIB II and RS-232 like groups:
<http://www.faqs.org/rfcs/rfc1213.html>
<http://www.faqs.org/rfcs/rfc1317.html>

The DA-661/662/663 does NOT support SNMP trap.

OpenVPN

OpenVPN provides two types of tunnels for users to implement VPNS: **Routed IP Tunnels** and **Bridged Ethernet Tunnels**. To begin with, check to make sure that the system has a virtual device /dev/net/tun. If not, issue the following command:

```
# mknod /dev/net/tun c 10 200
```

An Ethernet bridge is used to connect different Ethernet networks together. The Ethernets are bundled into one bigger, “logical” Ethernet. Each Ethernet corresponds to one physical interface (or port) that is connected to the bridge.

On each OpenVPN machine, you should generate a working directory, such as /etc/openvpn, where script files and key files reside. Once established, all operations will be performed in that directory.

Setup 1: Ethernet Bridging for Private Networks on Different Subnets

1. Set up four machines, as shown in the following diagram.

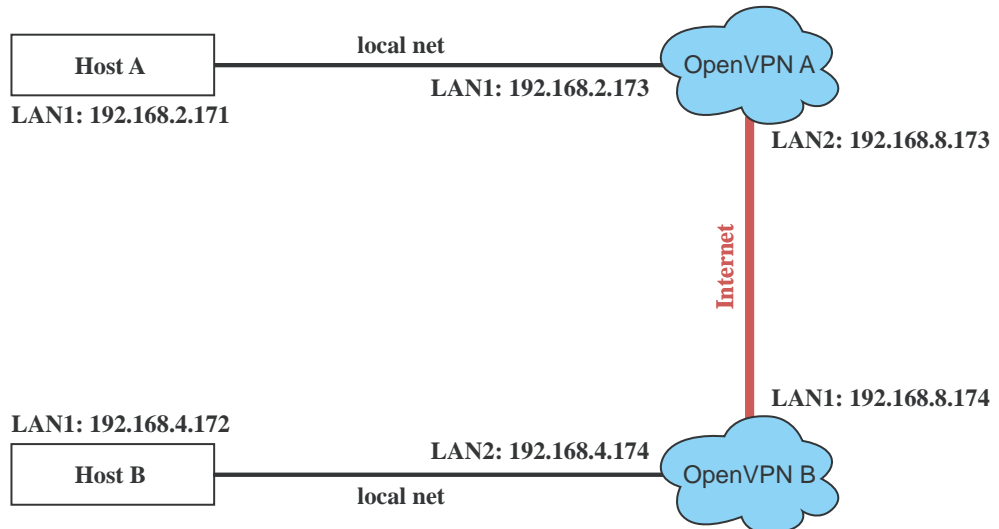

Host A (B) represents one of the machines that belongs to OpenVPN A (B). The two remote subnets are configured for a different range of IP addresses. When this setup is moved to a public network, the external interfaces of the OpenVPN machines should be configured for static IPs, or connect to another device (such as a firewall or DSL box) first.

```
# openvpn --genkey --secret secrouter.key
```

Copy the file that is generated to the OpenVPN machine.

2. The **openvpn-bridge** script file located at “/etc/openvpn/” reconfigures interface “eth1” as IP-less, creates logical bridge(s) and TAP interfaces, loads modules, enables IP forwarding, etc.

```
#-----Start-----
#!/bin/sh

iface=eth1 # defines the internal interface
maxtap=`expr 1` # defines the number of tap devices. I.e., # of tunnels

IPADDR=
NETMASK=
BROADCAST=

# it is not a great idea but this system doesn't support
# /etc/sysconfig/network-scripts/ifcfg-eth1
ifcfg_vpn()
{
while read f1 f2 f3 f4 r3
do
  if [ "$f1" = "iface" -a "$f2" = "$iface" -a "$f3" = "inet" -a "$f4" = "static" ];then
    i=`expr 0`
    while :
    do
      if [ $i -gt 5 ]; then
        break
      fi
      i=`expr $i + 1`
      read f1 f2
      case "$f1" in
        address ) IPADDR=$f2
          ;;
        netmask ) NETMASK=$f2
          ;;
        broadcast ) BROADCAST=$f2
          ;;
      esac
    done
    break
  fi
done < /etc/network/interfaces
}

# get the ip address of the specified interface
mname=
module_up()
{
oIFS=$IFS
IFS=`
`
FOUND="no"
for LINE in `lsmod`
do
  TOK=`echo $LINE | cut -d' ' -f1`
  if [ "$TOK" = "$mname" ]; then
    FOUND="yes";
    break;
  fi
done
IFS=$oIFS

if [ "$FOUND" = "no" ]; then
  modprobe $mname
fi
}
}
```



```

start()
{
ifcfg_vpn
if [ ! \( -d "/dev/net" \) ]; then
    mkdir /dev/net
fi

if [ ! \( -r "/dev/net/tun" \) ]; then
    # create a device file if there is none
    mknod /dev/net/tun c 10 200
fi

# load modules "tun" and "bridge"
mname=tun
module_up
mname=bridge
module_up
# create an ethernet bridge to connect tap devices, internal interface
brctl addbr br0
brctl addif br0 $iface
# the bridge receives data from any port and forwards it to other ports.

i=`expr 0`
while :
do
    # generate a tap0 interface on tun
    openvpn --mktun --dev tap${i}

    # connect tap device to the bridge
    brctl addif br0 tap${i}

    # null ip address of tap device
    ifconfig tap${i} 0.0.0.0 promisc up

    i=`expr $i + 1`
    if [ $i -ge $maxtap ]; then
        break
    fi
done

# null ip address of internal interface
ifconfig $iface 0.0.0.0 promisc up

# enable bridge ip
ifconfig br0 $IPADDR netmask $NETMASK broadcast $BROADCAST

ipf=/proc/sys/net/ipv4/ip_forward
# enable IP forwarding
echo 1 > $ipf
echo "ip forwarding enabled to"
cat $ipf
}

stop() {
echo "shutdown openvpn bridge."
ifcfg_vpn
i=`expr 0`
while :
do
    # disconnect tap device from the bridge
    brctl delif br0 tap${i}
    openvpn --rmtun --dev tap${i}

    i=`expr $i + 1`
    if [ $i -ge $maxtap ]; then
        break
    fi

```

```

done
brctl delif br0 $iface
brctl delbr br0
ifconfig br0 down
ifconfig $iface $IPADDR netmask $NETMASK broadcast $BROADCAST
killall -TERM openvpn
}

case "$1" in
  start)
    start
    ;;
  stop)
    stop
    ;;
  restart)
    stop
    start
    ;;
  *)
    echo "Usage: $0 [start|stop|restart]"
    exit 1
esac
exit 0
#----- end -----

```

Create link symbols to enable this script at boot time:

```

# ln -s /etc/openvpn/openvpn-bridge /etc/rc.d/rc3.d/S32vpn-br # for example
# ln -s /etc/openvpn/openvpn-bridge /etc/rc.d/rc6.d/K32vpn-br # for example

```

3. On machine OpenVPN A, modify the remote address in the configuration file, **/etc/openvpn/tap0-br.conf**.

```

# /etc/openvpn/tap0-br.conf
# point to the peer
remote 192.168.8.174
dev tap0
secret /etc/openvpn/secrouter.key
cipher DES-EDE3-CBC
auth MD5
tun-mtu 1500
tun-mtu-extra 64
ping 40
up /etc/openvpn/tap0-br.sh

```

Then modify the routing table in **/etc/openvpn/tap0-br.sh** script file.

```

#-----Start-----
#!/bin/sh
# /etc/openvpn/tap0-br.sh
# value after "-net" is the subnet behind the remote peer
route add -net 192.168.4.0 netmask 255.255.255.0 dev br0
#----- end -----

```

On machine OpenVPN B, modify the remote address in the configuration file, **/etc/openvpn/tap0-br.conf**.

```

# /etc/openvpn/tap0-br.conf
# point to the peer
remote 192.168.8.173
dev tap0
secret /etc/openvpn/secrouter.key
cipher DES-EDE3-CBC
auth MD5 tun-mtu 1500
tun-mtu-extra 64

```

```
ping 40
up /etc/openvpn/tap0-br.sh
```

Then modify the routing table in `/etc/openvpn/tap0-br.sh` script file.

```
#-----Start-----
#!/bin/sh
# /etc/openvpn/tap0-br.sh
# value after "-net" is the subnet behind the remote peer
route add -net 192.168.2.0 netmask 255.255.255.0 dev br0
#-----end-----
```

NOTE Select cipher by specifying **cipher**. To see which ciphers are available, type:

```
# openvpn --show-ciphers
```

- After configuring the remote peer, we can load the bridge into kernel, reconfigure eth1 and enable IP forwarding on both **OpenVPN** machine.

```
# /etc/openvpn/openvpn-bridge start
```

Then start both of OpenVPN peers,

```
# openvpn --config /etc/openvpn/tap0-br.conf &
```

If you see the line "Peer Connection Initiated with 192.168.8.173:1194" on each machine, the connection between OpenVPN machines has been established successfully on UDP port 1194.

NOTE You can create link symbols to enable the `/etc/openvpn/openvpn-bridge` script at boot time:

```
# ln -s /etc/openvpn/openvpn-bridge /etc/rc.d/rc3.d/S32vpn-br
# ln -s /etc/openvpn/openvpn-bridge /etc/rc.d/rc6.d/K32vpn-br
```

- On each OpenVPN machine, check the routing table by typing the command:

```
# route
```

Destination	Gateway	Genmsk	Flags	Metric	Ref	Use	Iface
192.168.4.0	*	255.255.255.0	U	0	0	0	br0
192.168.2.0	*	255.255.255.0	U	0	0	0	br0
192.168.8.0	*	255.255.255.0	U	0	0	0	eth0

Interface **eth1** is connected to the bridging interface **br0**, to which device **tap0** also connects, whereas the virtual device **tun** sits on top of **tap0**. This ensures that all traffic from internal networks connected to interface **eth1** that come to this bridge write to the TAP/TUN device that the OpenVPN program monitors. Once the OpenVPN program detects traffic on the virtual device, it sends the traffic to its peer.

- To create an indirect connection to Host B from Host A, you need to add the following routing item:

```
route add -net 192.168.4.0 netmask 255.255.255.0 dev eth0
```

To create an indirect connection to Host A from Host B, you need to add the following routing item:

```
route add -net 192.168.2.0 netmask 255.255.255.0 dev eth0
```

Now ping Host B from Host A by typing:

```
ping 192.168.4.174
```

A successful ping indicates that you have created a VPN system that only allows authorized users from one internal network to access users at the remote site. For this system, all data is transmitted by UDP packets on port 1194 between OpenVPN peers.

- To shut down OpenVPN programs, type the command:

```
# /etc/openvpn/openvpn-bridge stop
```

Setup 2: Ethernet Bridging for Private Networks on the Same Subnet

- Set up four machines as shown in the following diagram:

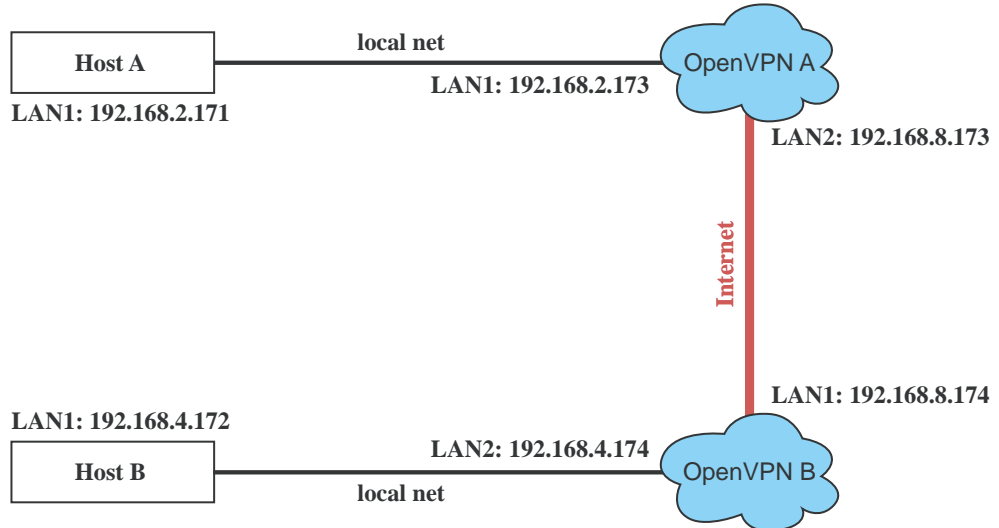

- The configuration procedure is almost the same as for the previous example. The only difference is that you will need to comment out the parameter “up” in “/etc/openvpn/tap0-br.conf” and “/etc/openvpn/tap0-br.conf”.

Setup 3: Routed IP

- Set up four machines as shown in the following diagram:

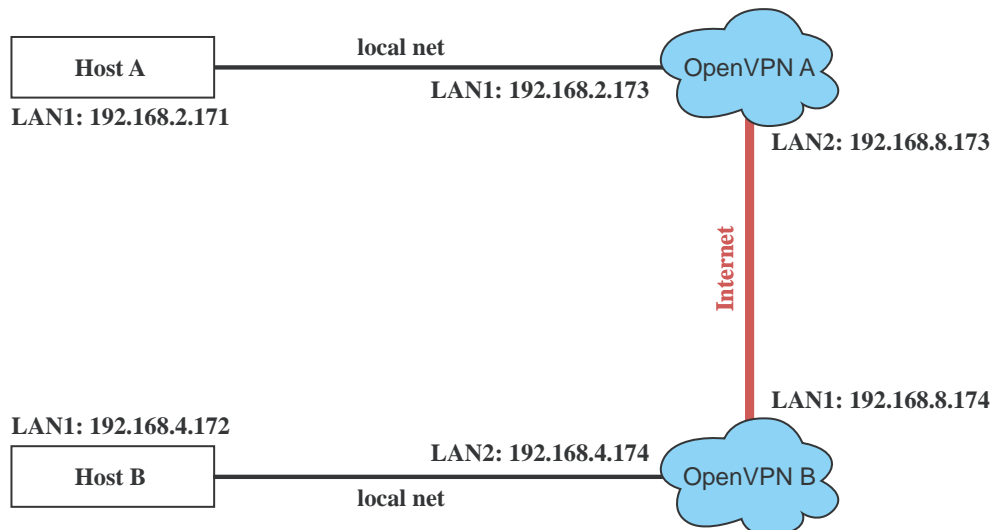

2. On machine OpenVPN A, modify the remote address in the configuration file, `/etc/openvpn/tun.conf`.

```
# point to the peer
remote 192.168.8.174
dev tun
secret /etc/openvpn/secrouter.key
cipher DES-EDE3-CBC
auth MD5
tun-mtu 1500
tun-mtu-extra 64
ping 40
ifconfig 192.168.2.173 192.168.4.174
up /etc/openvpn/tun.sh
```

Then modify the routing table in `/etc/openvpn/tun.sh` script file.

```
#-----Start-----
#!/bin/sh
# value after "-net" is the subnet behind the remote peer
route add -net 192.168.4.0 netmask 255.255.255.0 gw $5
#----- end -----
```

On machine OpenVPN B, modify the remote address in the configuration file, `/etc/openvpn/tun.conf`.

```
remote 192.168.8.173
dev tun
secret /etc/openvpn/secrouter.key
cipher DES-EDE3-CBC
auth MD5
tun-mtu 1500
tun-mtu-extra 64
ping 40
ifconfig 192.168.4.174 192.168.2.173
up /etc/openvpn/tun.sh
```

Then modify the routing table in `/etc/openvpn/tun.sh` script file.

```
#-----Start-----
#!/bin/sh
# value after "-net" is the subnet behind the remote peer
route add -net 192.168.2.0 netmask 255.255.255.0 gw $5
#----- end -----
```

NOTE	The parameter ifconfig defines the first argument as the local internal interface and the second argument as the internal interface at the remote peer.
------	--

NOTE	\$5 is the argument that the OpenVPN program passes to the script file. Its value is the second argument of <code>ifconfig</code> in the configuration file.
------	---

3. Check the routing table after you run the OpenVPN programs, by typing the command:

```
# route
```

Destination	Gateway	Genmsk	Flags	Metric	Ref	Use	Iface
192.168.4.174	*	255.255.255.255	UH	0	0	0	tun0
192.168.4.0	192.168.4.174	255.255.255.0	UG	0	0	0	tun0
192.168.2.0	*	255.255.255.0	U	0	0	0	eth1
192.168.8.0	*	255.255.255.0	U	0	0	0	eth0

5

Programmer's Guide

This chapter includes important information for programmers.

The following functions are covered in this chapter:

- Flash Memory Map**
- Linux Tool Chain Introduction**
- Debugging with GDB**
- Device API**
- RTC (Real-time Clock)**
- Buzzer**
- WDT (Watchdog Timer)**
- UART**
- LCM**
- KeyPad**
- Make File Example**

Flash Memory Map

Partition sizes are hard coded into the kernel binary. To change the partition sizes, you will need to rebuild the kernel. The flash memory map is shown in the following table.

Address	Size	Contents
0x00000000 – 0x0005FFFF	384 KB	Boot Loader—Read ONLY
0x00060000 – 0x001FFFFFFF	1.625 MB	Kernel object code—Read ONLY
0x00200000 – 0x00DFFFFFFF	14 MB	Root file system (JFFS2)—Read ONLY
0x00E00000 – 0x01FCFFFF	17.75 MB	User root file system (JFFS2)—Read/Write
0x01FC0000 – 0x01FDFFFF	128 KB	Boot Loader configuration—Read ONLY
0x01FE0000 – 0x01FFFFFFF	128 KB	Boot Loader directory—Read ONLY

- NOTE
1. The default Moxa file system only enables the network and CF. It lets users recover the user file system when it fails.
 2. The user file system is a complete file system. Users can create and delete directories and files (including source code and executable files) as needed.
 3. Users can create the user file system on the PC host or target platform, and then copy it to the DA-661/662/663.

Linux Tool Chain Introduction

To ensure that an application will be able to run correctly when installed on the DA-661/662/663, you must ensure that it is compiled and linked to the same libraries that will be present on the DA-661/662/663. This is particularly true when the RISC Xscale processor architecture of the DA-661/662/663 differs from the CISC x86 processor architecture of the host system, but it is also true if the processor architecture is the same.

The host tool chain that comes with the DA-661/662/663 contains a suite of cross compilers and other tools, as well as the libraries and headers that are necessary to compile applications for the DA-661/662/663. The host environment must be running Linux to install the DA-661/662/663 GNU Tool Chain. We have confirmed that the following Linux distributions can be used to install the tool chain:

Redhat 7.3/8.0/9.0, Fedora core 1/2/3/4/5.

The Tool Chain will need about 900 MB of hard disk space on your PC. The DA-661/662/663 Tool Chain is located on the DA-661/662/663 CD. To install the Tool Chain, insert the CD into your PC and then issue the following commands:

```
#mount -t iso9660 /dev/cdrom /mnt/cdrom
#cp /mnt/cdrom/tool-chain/linux/install.sh /tmp/
#sh /tmp/install.sh
```

Wait for a few minutes while the Tool Chain is installed automatically on your Linux PC. Once the host environment has been installed, add the directory `/usr/local/xscale_be/bin/` to your path and the directory `/usr/local/xscale_be/man/` to your manual path. You can do this temporarily for the current login session by issuing the following commands:

```
#export PATH="/usr/local/xscale_be/bin":$PATH
#export MANPATH="/usr/local/xscale_be/man":$MANPATH
```

Alternatively, you can add the same commands to `$HOME/.bash_profile` to cause it to take effect for all login sessions initiated by this user.

Obtaining help

Use the Linux man utility to obtain help on many of the utilities provided by the tool chain. For example to get help on the `xscale_be-gcc` compiler, issue the command:

```
#man xscale_be-gcc
```

Cross Compiling Applications and Libraries

To compile a simple C application, just use the cross compiler instead of the regular compiler:

```
#xscale_be-gcc -o example -Wall -g -O2 example.c
#xscale_be-strip -s example
#xscale_be-gcc -ggdb -o example-debug example.c
```

Tools Available in the Host Environment

Most of the cross compiler tools are the same as their native compiler counterparts, but with an additional prefix that specifies the target system. In the case of x86 environments, the prefix is `i386-linux-` and in the case of DA-661/662/663 Xscale boards, it is `xscale_be-`.

For example, the native C compiler is `gcc` and the cross C compiler for Xscale in DA-661/662/663 is `xscale_be-gcc`.

The following cross compiler tools are provided:

<code>ar</code>	Manage archives (static libraries)
<code>as</code>	Assembler
<code>c++, g++</code>	C++ compiler
<code>cpp</code>	C preprocessor
<code>gcc</code>	C compiler
<code>gdb</code>	Debugger
<code>ld</code>	Linker
<code>nm</code>	Lists symbols from object files
<code>objcopy</code>	Copies and translates object files
<code>objdump</code>	Displays information about object files
<code>ranlib</code>	Generates indexes to archives (static libraries)
<code>readelf</code>	Displays information about ELF files
<code>size</code>	Lists object file section sizes
<code>strings</code>	Prints strings of printable characters from files (usually object files)
<code>strip</code>	Removes symbols and sections from object files (usually debugging information)

Debugging with GDB

First compile the program must with option `-ggdb`. Use the following steps:

1. To debug a program called **hello-debug** on the target, use the command:

```
#gdbserver 192.168.4.142:2000 hello-debug
```

This is where 2000 is the network port number on which the server waits for a connection from the client. This can be any available port number on the target. Following this are the name of the program to be debugged (`hello-debug`), plus that program's arguments. Output similar to the following will be sent to the console:

```
Process hello-debug created; pid=38
```

2. Use the following command on the host to change to the directory that contains **hello-debug**:

```
cd /my_work_directory/myfilesystem/testprograms
```

3. Enter the following command:

```
#ddd --debugger xscale_be-gdb hello-debug &
```

4. Enter the following command at the GDB, DDD command prompt:

```
Target remote 192.168.4.99:2000
```

The command produces another line of output on the target console, similar to the following:

```
Remote debugging using 192.168.4.99:2000
```

192.168.4.99 is the machine's IP address, and 2000 is the port number. You can now begin debugging in the host environment using the interface provided by DDD.

5. Set a breakpoint on main by double clicking, or entering `b main` on the command line.
6. Click the **cont** button

Device API

The DA-661/662/663 supports control devices with the **ioctl** system API. You will need to use **include <mxadevice.h>**, and use the following **ioctl** function.

```
int ioctl(int d, int request,...);
```

Input: `int d` - open device node return file handle
`int request` - argument in or out

Use the desktop Linux's man page for detailed documentation:

```
#man ioctl
```

RTC (Real-time Clock)

The device node is located at `/dev/rtc`. DA-661/662/663 supports Linux standard simple RTC control. You must include **<linux/rtc.h>**.

1. Function: `RTC_RD_TIME`

```
int ioctl(fd, RTC_RD_TIME, struct rtc_time *time);
```

Description: read time information from RTC. It will return the value on argument 3.

2. Function: `RTC_SET_TIME`

```
int ioctl(fd, RTC_SET_TIME, struct rtc_time *time);
```

Description: set RTC time. Argument 3 will be passed to RTC.

Buzzer

The device node is located at `/dev/console`. The DA-661/662/663 supports Linux standard buzzer control, with the DA-661/662/663's buzzer running at a fixed frequency of 100 Hz. You must use **include <sys/kd.h>**.

Function: `KDMKTONE`

```
ioctl(fd, KDMKTONE, unsigned int arg);
```

Description: The buzzer's behavior is determined by the argument `arg`. The "high word" part of `arg` gives the length of time the buzzer will sound, and the "low word" part gives the frequency.

The buzzer's on/off behavior is controlled by software. If you call the "ioctl" function, you **MUST** set the frequency at 100 Hz. If you use a different frequency, the system could crash.

WDT (Watchdog Timer)

1. Introduction

The WDT works like a watchdog function. You can enable it or disable it. When the user enables WDT but the application does not acknowledge it, the system will reboot. You can set the ack time from a minimum of 50 msec to a maximum of 60 seconds.

2. How the WDT works

The sWatchDog is enabled when the system boots up. The kernel will auto ack it. The user application can also enable ack. When the user does not ack, it will let the system reboot.

Kernel boot

.....
....

User application running and enable user ack

....
....

3. The user API

The user application must include `<moxadef.h>`, and link `moxalib.a`. A makefile example is shown below:

```
all:
  xscale_be-gcc -o xxxx xxxx.c -lmoxalib
```

```
int swtd_open(void)
```

Description

Open the file handle to control the sWatchDog. If you want to do something you must first to this. And keep the file handle to do other.

Input

None

Output

The return value is file handle. If has some error, it will return < 0 value.

You can get error from `errno()`.

```
int swtd_enable(int fd, unsigned long time)
```

Description

Enable application sWatchDog. And you must do ack after this process.

Input

`int fd` - the file handle, from the `swtd_open()` return value.

`unsigned long time` - The time you wish to ack sWatchDog periodically. You must ack the sWatchDog before timeout. If you do not ack, the system will be reboot automatically. The minimal time is 50 msec, the maximum time is 60 seconds. The time unit is msec.

Output

OK will be zero. The other has some error, to get the error code from `errno()`.

```
int swtd_disable(int fd)
```

Description

Disable the application to ack sWatchDog. And the kernel will be auto ack it. User does not to do it at periodic.

Input

int fd - the file handle from swtd_open() return value.

Output

OK will be zero. The other has some error, to get error code from errno.

```
int swtd_get(int fd, int *mode, unsigned long *time)
```

Description

Get current setting values.

mode –

1 for user application enable sWatchDog: need to do ack.

0 for user application disable sWatchdog: does not need to do ack.

time – The time period to ack sWatchDog.

Input

int fd - the file handle from swtd_open() return value.

int *mode - the function will be return the status enable or disable user application need to do ack.

unsigned long *time - the function will return the current time period.

Output

OK will be zero.

The other has some error, to get error code from errno().

```
int swtd_ack(int fd)
```

Description

Acknowledge sWatchDog. When the user application enables WatchDog. It needs to call this function periodically using the user predefined time in the application program.

Input

int fd - the file handle from swtd_open() return value.

Output

OK will be zero.

The other has some error, to get error code from errno().

```
int swtd_close(int fd)
```

Description

Close the file handle.

Input

int fd - the file handle from swtd_open() return value.

Output

OK will be zero.

The other has some error, to get error code from errno().

4. Special Note

When you “kill the application with -9” or “kill without option” or “Ctrl+c” the kernel will change to auto ack the sWatchDog.

When your application enables the sWatchDog and does not ack, your application may have a logical error, or your application has made a core dump. The kernel will not change to auto ack. This can cause a serious problem, causing your system to reboot again and again.

5. User application example

Example 1:

```
#include <stdio.h>
#include <stdlib.h>
#include <string.h>
#include <moxadevice.h>

int main(int argc, char *argv[])
{
    int fd;

    fd = swtd_open();
    if ( fd < 0 ) {
        printf("Open sWatchDog device fail !\n");
        exit(1);
    }
    swtd_enable(fd, 5000); // enable it and set it 5 seconds
    while ( 1 ) {
        // do user application want to do
        ....
        ....
        swtd_ack(fd);
        ....
        ....
    }
    swtd_close(fd);
    exit(0);
}
```

The makefile is shown below:

```
all:
    xscale_be-gcc -o xxxx xxxx.c -lmoxalib
```

Example 2:

```
#include <stdio.h>
#include <stdlib.h>
#include <signal.h>
#include <string.h>
#include <sys/stat.h>
#include <sys/ioctl.h>
#include <sys/select.h>
#include <sys/time.h>
#include <moxadevice.h>

static void mydelay(unsigned long msec)
{
    struct timeval time;

    time.tv_sec = msec / 1000;
    time.tv_usec = (msec % 1000) * 1000;
    select(1, NULL, NULL, NULL, &time);
}
```

```

static int swtdfd;
static int stopflag=0;

static void stop_swatcdog()
{
    stopflag = 1;
}

static void do_swatcdog(void)
{
    swtd_enable(swtdfd, 500);
    while ( stopflag == 0 ) {
        mydelay(250);
        swtd_ack(swtdfd);
    }
    swtd_disable(swtdfd);
}

int main(int argc, char *argv[])
{
    pid_t sonpid;

    signal(SIGUSR1, stop_swatcdog);
    swtdfd = swtd_open();
    if ( swtdfd < 0 ) {
        printf("Open sWatchDog device fail !\n");
        exit(1);
    }
    if ( (sonpid=fork()) == 0 )
        do_swatcdog();
    // do user application main function
    ....
    ....
    ....
    // end user application
    kill(sonpid, SIGUSR1);
    swtd_close(swtdfd);
    exit(1);
}

```

The makefile is shown below:

```

all:
    xscale_be-gcc -o xxxx xxxx.c -lmoxalib

```

UART

The normal tty device node is located at **/dev/ttyM0 ... ttyM15**, and the modem tty device node is located at **/dev/cum0 ... cum15**.

The DA-661/662/663 supports Linux standard termios control. The Moxa UART Device API allows you to configure ttyM0 to ttyM7 as RS-232, RS-422, 4-wire RS-485, or 2-wire RS-485. The DA-661/662/663 supports RS-232, RS-422, 2-wire RS-485, and 4-wire RS485.

You must use **include <moxadevice.h>**.

```

#define RS232_MODE      0
#define RS485_2WIRE_MODE  1
#define RS422_MODE      2
#define RS485_4WIRE_MODE  3

```

1. Function: MOXA_SET_OP_MODE

```
int ioctl(fd, MOXA_SET_OP_MODE, &mode)
```

Description

Set the interface mode. Argument 3 mode will pass to the UART device driver and change it.

2. Function: MOXA_GET_OP_MODE

```
int ioctl(fd, MOXA_GET_OP_MODE, &mode)
```

Description

Get the interface mode. Argument 3 mode will return the interface mode.

There are two Moxa private ioctl commands for setting up special baudrates.

Function: MOXA_SET_SPECIAL_BAUD_RATE

Function: MOXA_GET_SPECIAL_BAUD_RATE

If you use this ioctl to set a special baudrate, the termios cflag will be B4000000, in which case the B4000000 define will be different. If the baudrate you get from termios (or from calling tcgetattr()) is B4000000, you must call ioctl with MOXA_GET_SPECIAL_BAUD_RATE to get the actual baudrate.

Example for setting the baudrate

```
#include <moxadevice.h>
#include <termios.h>
struct termios term;
int fd, speed;
fd = open("/dev/ttyM0", O_RDWR);
tcgetattr(fd, &term);
term.c_cflag &= ~(CBAUD | CBAUDEX);
term.c_cflag |= B4000000;
tcsetattr(fd, TCSANOW, &term);
speed = 500000;
ioctl(fd, MOXA_SET_SPECIAL_BAUD_RATE, &speed);
```

Example for getting the baudrate

```
#include <moxadevice.h>
#include <termios.h>
struct termios term;
int fd, speed;
fd = open("/dev/ttyM0", O_RDWR);
tcgetattr(fd, &term);
if ( (term.c_cflag & (CBAUD|CBAUDEX)) != B4000000 ) {
    // follow the standard termios baudrate define
} else {
    ioctl(fd, MOXA_GET_SPECIAL_BAUD_RATE, &speed);
}
```

Baudrate inaccuracy

Divisor = 921600/Target Baudrate. (Only Integer part)

ENUM = 8 * (921600/Target - Divisor) (Round up or down)

Inaccuracy = ((Target Baud Rate – 921600/(Divisor + (ENUM/8))) / Target Baud Rate) * 100%

E.g.,

To calculate 500000 bps

Divisor = 1, ENUM = 7,

Inaccuracy = 1.7%

*The Inaccuracy should less than 2% for work reliably.

Special Note

1. If the target baudrate is not a special baudrate (e.g. 50, 75, 110, 134, 150, 200, 300, 600, 1200, 1800, 2400, 4800, 9600, 19200, 38400, 57600, 115200, 230400, 460800, 921600), the termios cflag will be set to the same flag.
2. If you use stty to get the serial information, you will get speed equal to 0.

LCM

The DA-661/662/663 only supports text mode display, with screen size of 16 cols by 2 rows. The device node is `/dev/lcm`. See the examples given below. We provide a private struct defined as follows:

```
typedef struct lcm_xy {
    int x; // col value, the arrange is 0 - 15
    int y; // raw value, the arrange is 0 - 1
} lcm_xy_t;
```

Examples

```
int ioctl(fd, IOCTL_LCM_GOTO_XY, lcm_xy_t *pos);
```

Move the cursor position to x(col),y(raw) position. The argument 3 is the new position value.

```
int ioctl(fd, IOCTL_LCM_CLS, NULL);
```

Clears the LCM display.

```
int ioctl(fd, IOCTL_LCM_CLEAN_LINE, NULL);
```

To change one line to all spaces in the current row, and move the cursor to the 0 column of this row.

```
int ioctl(fd, IOCTL_LCM_GET_XY, lcm_xy_t *pos);
```

Get the current cursor position. The value will be returned in argument 3.

```
int ioctl(fd, IOCTL_LCM_BACK_LIGH_ON, NULL);
```

Turns the LCM backlight on.

```
int ioctl(fd, IOCTL_LCM_BACK_LIGHT_OFF, NULL);
```

Turns the LCM backlight off.

KeyPad

The device node is `/dev/keypad`. The key value is defined in `moxadevice.h`.

```
int ioctl(fd, IOCTL_KEYPAD_HAS_PRESS, int *flag);
```

Checks how many keys have been pressed. Argument 3 returns the number of pressed keys. 0 means no keys were pressed.

```
int ioctl(fd, IOCTL_KEYPAD_GET_KEY, int *key);
```

Gets the value of the last key that was pressed. This functions only reads one key value for each function call. The value of the key value is returned in argument 3.

Special Note

1. The DA-661/662/663's kernel will store the "pressed key history" in a buffer. The maximum buffer size is 31 keys. If the buffer overflows, the first key of the 31 that was pressed will be dropped, without sounding the buzzer.
2. Currently, the DA-661/662/663 does NOT support pressing more than 1 key at the same time.

Make File Example

The following Makefile file example codes are copied from the Hello example on the DA-661/662/663 CD-ROM.

```
CC = xscale_be-gcc
CPP = xscale_be-gcc
SOURCES = hello.c

OBJS = $(SOURCES:.c=.o)

all: hello

hello: $(OBJS)
$(CC) -o $@ $^ $(LDFLAGS) $(LIBS)

clean:
rm -f $(OBJS) hello core *.gdb
```

A

System Commands

Linux normal command utility collection

File Manager

- | | |
|-----------|---|
| 1. cp | copy file |
| 2. ls | list file |
| 3. ln | make symbolic link file |
| 4. mount | mount and check file system |
| 5. rm | delete file |
| 6. chmod | change file owner & group & user |
| 7. chown | change file owner |
| 8. chgrp | change file group |
| 9. sync | sync file system, let system file buffer be saved to hardware |
| 10. mv | move file |
| 11. pwd | display now file directly |
| 12. df | list now file system space |
| 13. mkdir | make new directory |
| 14. rmdir | delete directory |

Editor

- | | |
|----------|---------------------------|
| 1. vi | text editor |
| 2. cat | dump file context |
| 3. zcat | compress or expand files |
| 4. grep | search string on file |
| 5. cut | get string on file |
| 6. find | find file where are there |
| 7. more | dump file by one page |
| 8. test | test file exist or not |
| 9. sleep | sleep (seconds) |
| 10. echo | echo string |

Network

- | | |
|--------------|------------------------|
| 1. ping | ping to test network |
| 2. route | routing table manager |
| 3. netstat | display network status |
| 4. ifconfig | set network ip address |
| 5. tracerout | trace route |
| 6. tftp | |
| 7. telnet | |
| 8. ftp | |

Process

1. **kill** **kill process**
2. **ps** **display now running process**

Other

1. **dmesg** **dump kernel log message**
2. **stty** **to set serial port**
3. **zcat** **dump .gz file context**
4. **mknod** **make device node**
5. **free** **display system memory usage**
6. **date** **print or set the system date and time**
7. **env** **run a program in a modified environment**
8. **clear** **clear the terminal screen**
9. **reboot** **reboot / power off/on the server**
10. **halt** **halt the server**
11. **du** **estimate file space usage**
12. **gzip, gunzip** **compress or expand files**
13. **hostname** **show system's host name**

Moxa Special Utilities

1. **kversion** **show kernel version**
2. **cat /etc/version** **show user directory version**
3. **upramdisk** **mount ramdisk**
4. **downramdisk** **unmount ramdisk**

B

Using the Push Buttons to Operate the LCD Screen

The DA-661/662/663 embedded computers implement a set of LCD functions to provide users with on-site parameter readings of the current state of the computer. The LCD screen is operated using the four push buttons. The parameters include the model name, firmware version, network settings, in addition to other parameters. We use the DA-661/662/663-LX as an example to demonstrate the steps to obtain these parameters.

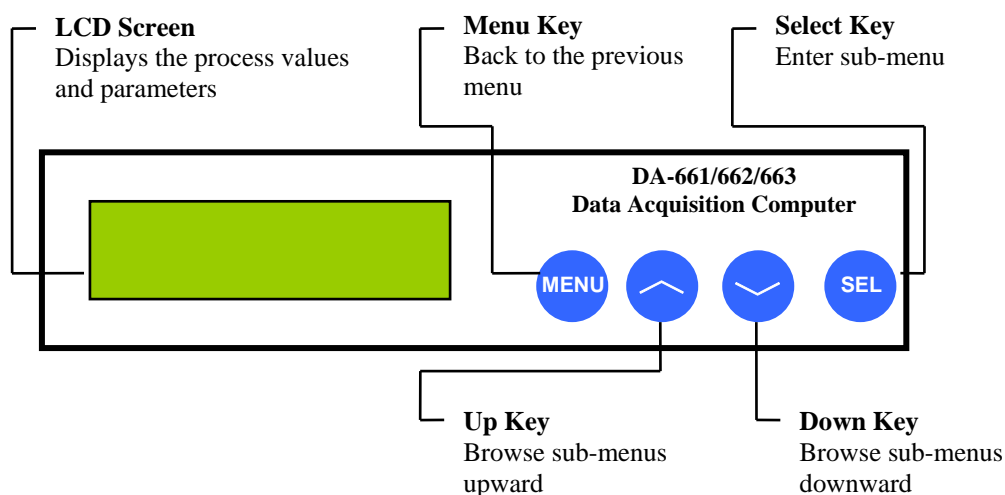

A typical example:

- **Model Name and Firmware Version**—Screen that appears when the system boots up.

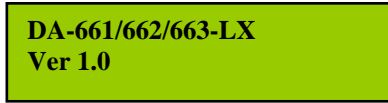

Press **MENU** to enter the main menu.

- **Main Menu**



Press **▽** or use **SEL** to select an item.



Press **▽** or use **SEL** to select an item.



Press **△** or use **SEL** to select an item.

- **Network Settings (Port eth0 for example)**



Press **SEL**.



Press **SEL**.



Press **▽**.



Press **▽**.



Press **▽**.

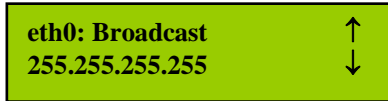

Press **△**.

- **Serial Port (Port #1 for example)**



Press **SEL**.

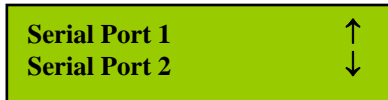

Press **SEL**.

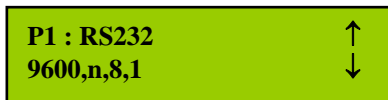

Press **▽** for port 2.

- Console Port

Console Port
Return

Press **SEL**.

Console: Enable
115200,n,8,1