

# **Moxa Industrial Video Encoder**

---

## **VPort 461 Series Quick Installation Guide**

**First Edition, November 2009**



© 2009 Moxa Inc. All rights reserved.  
Reproduction without permission is prohibited.

Fl.4, No.135, Lane 235, Pao-Chiao Rd. Shing Tien City, Taipei, Taiwan,  
R.O.C.

TEL: +886-2-8919-1230

P/N: 1802004610010

# Overview

The VPort 461 is a 1-channel Industrial Video Encoder with H.264 video compression. The H.264 algorithm provides the best video quality on the market today with lower bandwidth requirements than other video compression standards. In addition, to meet requirements for multiple video streams, the VPort 461 can provide up to 3 video streams simultaneously with H.264 and MJPEG compression. Users can use the video streams for different purposes, such as viewing, recording or analysis. Finally, the industrial-rugged design, with -40 to 75°C operating temperature, built-in fiber Ethernet ports, IP30 form factor protection, and industrial certifications, make the VPort 461 suitable for the harsh environment.

## Package Checklist

The VPort 461 ships with the following items:

- VPort 461.
- 6-pin terminal block for 1 power input and 2 digital inputs.
- 8-pin terminal block for the other power input, and 2 relay outputs.
- 5-pin terminal block for the RS-232/422/RS-485 PTZ control port.
- Quick Installation Guide.
- Document & Software CD (includes User's Manual, Quick Installation Guide, Moxa IVN Solution Datasheet and Utility).
- Warranty Card.

*Note: If any of these items are missing or damaged, please contact your customer service representative for assistance.*

**NOTE** Check the model name on the VPort's side label to determine if the model name is correct for your order.

**NOTE** This product must be installed in compliance with your local laws and regulations.

## Features

### *High Performance Audio-Video Networking Solution*

- Works with NTSC/PAL analog video cameras.
- Supports H.264/MJPEG video compression technologies.
- Up to 3 simultaneous video streams (2 H.264 and 1 MJPEG).
- Lower latency, under 200 ms.
- 1 BNC video input.
- Video stream up to 30 frames/sec in Full D1 (720 x 480) resolution in NTSC, and 25 frames/ sec in Full D1 (720 x 576) resolution in PAL.
- Select between Full D1/ 4CIF/ VGA/ CIF/ QCIF resolutions.
- 1 audio input and 1 audio output for 2-way voice communication.
- TCP, UDP, and HTTP network transmission modes.

- Supports Modbus/TCP for easy communication with SCADA systems.
- Supports standard RTSP (Real-time streaming protocol) for easy integration.
- Supports multicast (IGMP) protocols for efficient network transmission.
- Supports QoS (TOS) for priority transmission.
- Supports SNMP V1/V2c/V3 for network management.
- Built-in web server and RS-232 console for remote access and configuration.
- Supports one SD card slot (SDHC interface) for local video recording on the SD card during network interruptions.
- Two auto-sensing 10/100BaseT(X) Ethernet ports.
- Maximum 10 output video streams and 10 client connections.
- Set up video quality in CBR (constant bit rate) or VBR (variable bit rate).
- Supports 1 RS-232/422/485 DB9 COM port for controlling a PTZ (PAN/TILT/ZOOM) motorized camera or serial device via a TCP/IP network.
- Supports 1 RS-232/RS-422/RS-485 5-pin PTZ port for controlling a PTZ (PAN/TILT/ZOOM) motorized camera via a TCP/IP network.
- UPnP and IP filtering supported.

### ***Rugged Industrial Design***

- Two 12/24 VDC and 24 VAC redundant power inputs with LED indicators
- -40 to 75°C operating temperature for harsh industrial environments (“T” model)
- 35 mm DIN-Rail mounting or panel mounting installation (with optional accessory)
- IP30 form factor protection
- CE, FCC, UL508 approvals for industrial applications

### ***Intelligent Alarm Trigger Capability***

- Built-in Video Motion Detection (VMD) (firmware version V2.0 and later)
- Equipped with 2 DIs and 2 relays (DO) for external sensors and alarms.
- Pre, trigger, and post alarm snapshot images provided.
- Supports sequential snapshot images
- Messages with snapshot images can be sent via FTP and email.
- Capable of setting an alarm schedule

### ***Video Management and Control***

- Free Moxa VPort SDK Plus (software development kits) supported with flexible interface and sample codes for customized application or system integration.
- Moxa SoftNVR-IA IP surveillance software supported for the video recording and management solution.

**NOTE** VMD alarms are supported by V2.0 firmware version and later

**NOTE** If you are interested in the Moxa VPort SDK PLUS, please go to Moxa's website ([www.moxa.com](http://www.moxa.com)) to download the software, or contact a Moxa sales representative for more information.

**NOTE** If you are interested in SoftNVR-IA IP surveillance software, please go to Moxa's website ([www.moxa.com](http://www.moxa.com)) to download the trial version.

# VPort 461 Panel Layout

Top Panel View

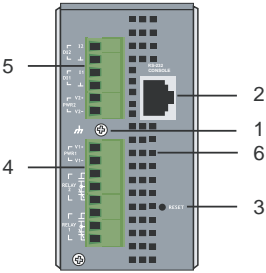

Front Panel View

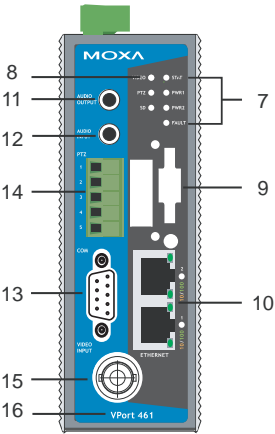

Rear Panel View

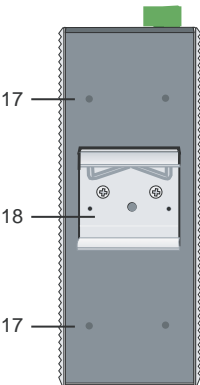

1. Grounding screw
2. RS-232 console port
3. Hardware reset button
4. 8-pin terminal block for Relay 1, Relay 2, and power input 1 (PWR1)
5. 6-pin terminal block for DI 1, DI 2, power input 2 (PWR2)
6. Heat dissipation orifices
7. LEDs for STAT, PWR1, PWR2, FAULT
8. LEDs for VIDEO, PTZ and SD
9. SD card (SDHC) slot
10. 2 RJ45 10/100BaseTX Ethernet port with 10 /100 Mbps LED
11. AUDIO OUTPUT port for external speaker
12. AUDIO INPUT port for mic-in and line-in connection
13. RS-232/422/485 COM port with DB9 male connector for PTZ camera or serial device control
14. RS-232/422/485 PTZ port with 5-pin terminal block for PTZ camera control
15. 1 BNC connector for video input
16. Model name
17. Screw hole for wall mounting kit
18. DIN-Rail mounting kit

# First-Time Installation and Configuration

Before installing the VPort 461, check to make sure that all items in the package checklist are in the box. In addition, you will need access to a notebook computer or PC equipped with an Ethernet port.

## Step 1: Select the Power Source

The VPort 461 can be powered by a DC power input from 12 to 32 VDC, or an AC power input from 18 to 30 VAC. Two power inputs are provided for redundancy. Users can check the LED status located in the front panel to see if the power inputs are connected appropriately. If one of the power inputs fails, the FAULT LED will light up in red if the power failure alarm is enabled.

**NOTE** The VPort 461 series supports power input specifications of 12-32 VDC for 12/24 VDC power input, or 18-30 VAC for 24 VAC power input (note that this is different from Moxa EDS switch's 12-45 VDC power input).

## Step 2: Connect the VPort 461 to a Network

The VPort 461 has two auto-sensing 10/100 Mbps RJ45 Ethernet ports for network connectivity. Each has a LED indicator located aside for indicating the 10 Mbps or 100 Mbps Ethernet connections.

**NOTE** These two Ethernet port can be cascaded in daisy chain link, or connected to two different switch ports for Ethernet port redundancy. More than that, they are also switch ports, which means you can connect a Ethernet device on one of them for saving the one switch port in the field site.

## Step 3: Connect the VPort 461 to cameras and an audio source

The VPort 461 has 1 VIDEO INPUT port. Use the BNC connector (1.0 Vpp, 75Ω) and coaxial cable to connect video cameras to the VPort to input analog video signals.

The VPort 461 has one audio input and one audio output. A microphone or an amplifier can be plugged directly into the AUDIO INPUT port, and a speaker can be plugged into the AUDIO OUTPUT port.

**NOTE** One VIDEO LED is located on the VPort 461's front panel to indicate the video signal transmission status for video input. Check the LED status to see if the video is working properly.



### ATTENTION

A ground loop isolator is recommended to be used between the camera and the VPort to avoid a sudden current, which is generated by the electric potential difference between these two device's ground power, to burn out the VPort's chips and boards.

#### Step 4: Connecting motorized PTZ cameras and serial devices

The VPort 461 has two RS-232/422/485 ports. One is a COM PORT with DB9 male connector, and the other is a PTZ PORT with 5-pin terminal block connector. Both ports can be used for connecting PTZ control cables for controlling PTZ cameras over the TCP/IP network.

In addition, the DB9 male COM PORT can also be used to connect general serial devices, such as card readers, for transmitting serial data over a TCP/IP network. This port can be used to connect serial devices to the VPort 461 instead of a video camera.

To enable PTZ control, users should configure the PTZ control protocol in the web-based manager.

**NOTE** The PTZ control protocol is not standardized. To use a particular PTZ control protocol, the video server must support the driver for that protocol. Currently, the VPort 461 supports PTZ control protocol drivers for:

1. Pelco D
2. Pelco P
3. DynaColor DynaDome
4. Yokogawa (Fieldeye)
5. Cohu

If you need to use a protocol that is not on the list, contact the manufacturer of the camera to get the PTZ control commands, and then program its PTZ control using the VPort 461's **Custom Camera** function.

**NOTE** The VPort 461 comes with a PTZ driver upload function for implementing new PTZ drivers. Please contact a Moxa sales representative if you need assistance from Moxa's R&D department to create a new PTZ driver.

**NOTE** The "Transparent PTZ Control" function in the camera driver list is used to transmit the PTZ control signal over a TCP/IP network to the VPort D361 video decoder or PC (additional driver required). The PTZ control panel or keyboard can directly control the PTZ camera or device, eliminating the need for a PTZ camera driver and allowing the use of PTZ cameras with the VPort encoder.

#### Step 5: Configure the VPort 461's IP address

After powering on the VPort 461, wait a few seconds for the POST (Power On Self Test) to run. The STAT LED turns green to indicate that the POST process has completed. The IP address will be assigned when the 10/100 Mbps NETWORK LED blinks. The IP address assigned after the POST is completed depends on the network environment.

#### Network Environment with DHCP Server

In this case, the IP address of the VPort 461 is assigned by a DHCP Server. Use the DHCP Server's IP address table, or use the Moxa VPort utility to determine the IP address that was assigned by the DHCP Server.

**NOTE** After powering on the VPort 461, wait a few seconds for the POST (Power On Self Test) to run. The IP address will be assigned when the 10/100 Mbps NETWORK LED blinks.

## Using the Moxa VPort and EtherDevice Configurator Utility (edscfgui.exe)

1. Run the **edscfgui.exe** program to search for the VPort and EDS switches. After the Utility window opens, select or click on Broadcast Search, which is located under the List Server menu, to initiate a search (note that you can also click on Broadcast Search  icon to initiate a search).

**NOTE** You may download the VPort and EtherDevice Configurator software from Moxa's website at [www.moxa.com](http://www.moxa.com).

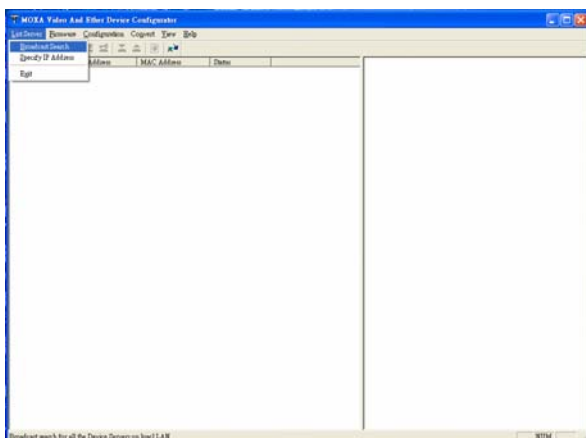

2. The Broadcast Search window will show a list of all switches and VPorts located on the network. The progress of the search will also be indicated.

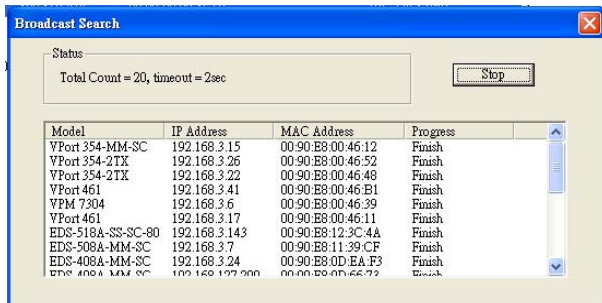



- When the search has ended, the Model Name, MAC address, and IP address of the EDS switches and VPorts will be listed in the Utility window.

Model	IP Address	MAC Address	Status	Name	VPort
VPort 354-2TX	192.168.3.39	00:09:EB:00:46:BF		VPort 354-2TX	VPort 461
VPort 25-CAM3ES	192.168.3.34	00:90:EB:22:33:44		VPort 25-C	VPort 461 Video Encode
VPort 254-M-2C	192.168.3.45	00:90:EB:11:02:45		VPort 254-1	IP Address 192.168.3.25
VPort 254-M-2C-T	192.168.3.41	00:90:EB:AA:BB:11		VPort 254-1	Netmask 255.255.255.0
VPort 354-2TX	192.168.3.42	00:09:EB:00:46:AF		VPort 354-2TX	Gateway 192.168.3.254
TR-5516-8POE	192.168.127.253	00:90:EB:76:54:52		Managed R...	MAC Address 00:0a:19:74:12:13
EDG-408A-MM-2C	192.168.3.12	00:90:EB:00:46:73		Managed R...	Serial No 00001
EDG-408A-MM-2C	192.168.3.89	00:00:00:00:00:00		Managed R...	Firmware Ver. 1.0
EDG-408A-MM-2C	192.168.127.253	00:00:00:12:34:55	Locked	Managed R...	Bios Ver. 0.0.0
EDG-908A	192.168.3.36	00:90:EB:19:12:7E		Managed R...	Http port 80
VPort 351(GD1)	192.168.3.43	00:90:EB:10:C4:11		VPort 351(G	
EDG-408A-MM-2C	192.168.127.253	00:90:EB:EB:EB:44		Managed R...	
VPort 254	192.168.3.207	00:90:EB:00:46:28		VPort 254	
VPort 254-M-2C-T	192.168.3.32	00:90:EB:00:46:98		VPort 254-1	
PT-7626	192.168.3.188	00:90:EB:01:01:01		Moem PT-7	
EDG-518A-MM-2C	192.168.3.252	00:90:EB:00:00:03	Locked Incomm...	Moxa EDG-	
VPort 15-M12-NT2C	192.168.3.58	00:0D:89:03:7F:9F		VPort 15-M	
VPort 15-M12-NT2C	192.168.3.55	00:0D:89:01:F3:E7		VPort 15-M	
ED6008-MM-2C	192.168.3.171	00:90:EB:09:F7:18		MOXA Eth	
ED6008-2C-T	192.168.1.29	00:90:EB:08:6E:85		MOXA Eth	
ED6008	192.168.3.160	00:90:EB:00:00:4A		MOXA Eth	
ED6008	192.168.3.248	00:90:EB:08:51:9B		MOXA Eth	
ED6008-2C-T	192.168.1.25	00:90:EB:08:6E:80		MOXA Eth	
VPort 15-N	192.168.3.20	00:0D:89:04:A3:30		VPort 15-N	
VPort 351-M-2C-T	192.168.3.19	00:90:EB:17:F6:27		VPort 351-1	
VPort 351	192.168.3.206	00:90:EB:10:09:80		VPort 351	
EDG-518A-MM-2C	192.168.3.253	00:90:EB:09:09:09		Managed R...	

**NOTE** Broadcast Search can only search for devices connected to the same LAN subnet as the VPort. If your devices are located on a different LAN subnet, use the “Specify IP Address” function to search for the device by keying in the IP address.

- Double click the selected VPort, or use Internet Explorer to access the VPort’s web-based manager (web console).

### Network Environment without a DHCP Server

If your VPort 461 is connected to a network that does not have a DHCP server, then you will need to configure the IP address manually. The default IP address of the VPort 461 is **192.168.127.100** and the default subnet mask is 255.255.255.0. Note that you may need to change your computer’s IP address and subnet mask so that the computer is on the same subnet as the VPort.

To change the IP address of the VPort manually, access the VPort’s web server, and then navigate to the **System Configuration → Network → General** page to configure the IP address and other network settings. Select the **Use fixed IP address** checkbox to ensure that the IP address you assign is not deleted each time the VPort is restarted.

### **Step 6: Log on to the VPort 461 web-based manager**

Type the IP address in the web browser’s address input box and then press enter.

## Step 7: Install the ActiveX Control Plug-in

A security warning message will appear the first time you access the VPort's web-based manager. The message is related to installing the VPort ActiveX Control component to your PC or notebook. Click on Yes to install this plug-in to enable the ability to view video in the IE web browser.



**NOTE** For Windows XP SP2 or later operating systems, the ActiveX Control component will be blocked for system security reasons. In this case, the VPort's security warning message window may not appear. Users should unblock the ActiveX control function or disable the security configuration to enable the installation of VPort's ActiveX Control component.

## Step 8: Accessing the homepage of the VPort 461's web-based manager

After installing the ActiveX Control component, the homepage of the VPort 461's web-based manager will appear. Check the following items to make sure the system was installed properly:

1. Video Images.
2. Audio Sound (make sure your PC's or notebook's sound is turned on).
3. Video Information.

## Step 9: Accessing the VPort's System Configuration

Click on System Configuration to access the overview of the system configuration to change the configuration. Model Name, Server Name, IP Address, MAC Address, Firmware Version, and LED Status appear in the green bar near the top of the page. Use this information to check the system information and installation.

For details of each configuration, check the User's Manual on the software CD.

The screenshot shows the web-based manager interface for the VPort 461 Video Encoder. At the top, there is a green header bar with the MOXA logo and the title "VPort 461 Video Encoder". Below the header, a status bar displays various system parameters: Model Name (VPort 461), Server Name (VPort 461 Video Encoder), IP Address (192.168.3.25), MAC Address (90A8:00:7A:12:03), and Firmware Version (1.8). There are also buttons for State, Power1, Power2, and Fault, and a section for Video settings (F1Z, S0).

The main content area is titled "System Configuration" and includes a welcome message: "Welcome to the System Configuration pages. A brief description of each configuration group is given below. Click on a plus sign in the left pane to expand a group, and then click on the name of the page you would like to open." Below this is a table with three columns: Category, Item, and Description and Content.

Category	Item	Description and Content
	General	Setting Host Name and Date/Time
	Account	Administrator, User and Demo Account Privileges Management
	Local Storage	Set up the local storage capability
	Diagnosis	Self-diagnostic report with system, communication, power and IO status
	System Log	System Log and operation information
	System Parameter	System parameters information and Import/Export function
	Firmware Upgrade	Remote Firmware Upgrade
	Factory Default	Reset to Factory Default
	Reboot	Device will reboot for restarting system
	General	The IP network settings of this VPort
	SMTP Server	Set up Primary and Secondary SMTP Server and E-mail accounts
	FTP Server	Set up the Primary and Secondary FTP Server
	DDNS	Configure DDNS
	Universal PnP	Enable UPnP function
	Multicast Setting	Set up Multicast (IGMP) Streaming
	Accessible IP	Set up a list to control the access permission of clients by checking their IP address
	SNMP	Configure the SNMP settings
	QoS(ToS)	Configure ToS(Type of Service)

**NOTE** After accessing the VPort 461's web-based manager, administrators should access **System Configuration** → **System** → **Account** to set up the administrator's password and enable the authentication function. The administrator account name is admin. An authentication window will pop up requesting the account name and password each time the VPort 461 is accessed.

The screenshot shows a Windows-style dialog box titled "Connect to 192.168.3.25". The dialog box has a blue header bar with a question mark icon and a close button. Below the header, there is a key icon and the text "VPort 461 Video Encoder". The main area contains a "User name:" label with a dropdown menu showing a user icon, a "Password:" label with a text input field, and a checkbox labeled "Remember my password". At the bottom, there are "OK" and "Cancel" buttons.

# Mounting Dimensions (unit = mm)

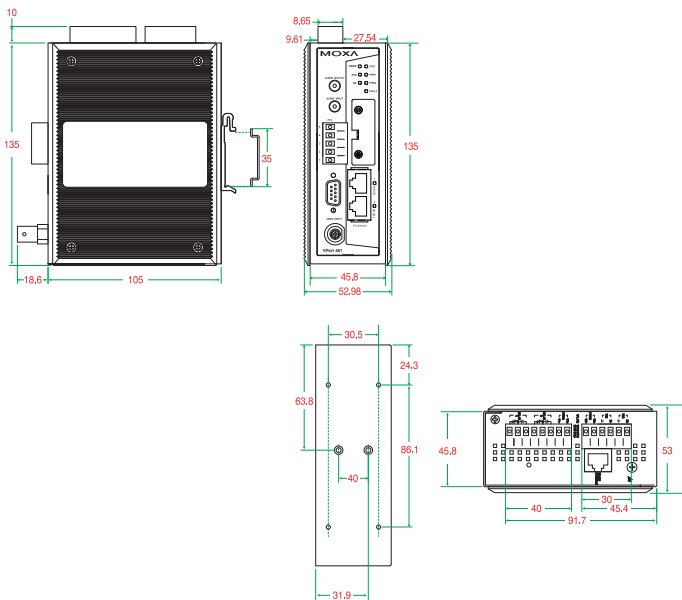

## DIN-Rail Mounting

The aluminum DIN-Rail attachment plate should already be attached to the back panel of the VPort 461 when you take it out of the box. If you need to reattach the DIN-Rail attachment plate to the VPort 461, make sure the stiff metal spring is situated towards the top, as shown in the figures below.

**STEP 1:** Insert the top of the DIN-Rail into the slot just below the stiff metal spring.

**STEP 2:** The DIN-Rail attachment unit will snap into place as shown below.

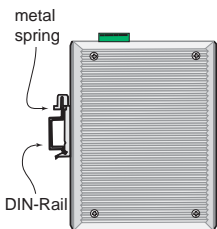
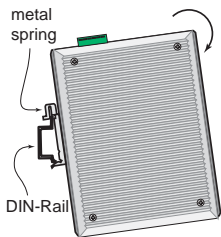

To remove the VPort 461 from the DIN-Rail, simply reverse Steps 1 and 2 above.

## Wall Mounting (optional)

For some applications, you will find it convenient to mount the VPort 461 on a wall, as illustrated below.

### STEP 1:

Remove the aluminum DIN-Rail attachment plate from VPort 461, and then attach the wall mount plates, as shown in the diagrams below.

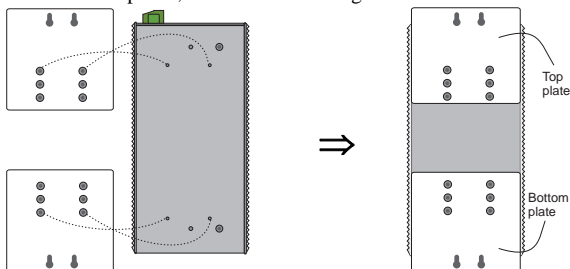

### STEP 2:

Mounting VPort 461 on the wall requires 4 screws. Use the VPort 461, with wall mount plates attached, as a guide to mark the correct locations of the 4 screws. The heads of the screws should be less than 6.0 mm in diameter, and the shafts should be less than 3.5 mm in diameter, as shown in the figure at the right.

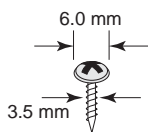

Do not screw the screws in all the way—leave a space of about 2 mm to allow room for sliding the wall mount panel between the wall and the screws.

**NOTE** Test the screw head and shank size by inserting the screw into one of the keyhole shaped apertures of the wall mounting plates, before it is screwed into the wall.

### STEP 3:

Once the screws are fixed in the wall, insert the four screw heads through the large parts of the keyhole-shaped apertures, and then slide the VPort 461 downwards, as indicated below. Tighten the four screws for added stability.

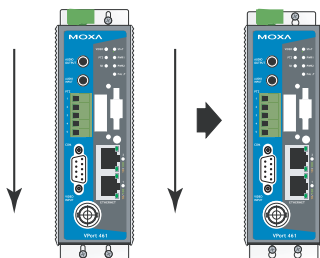

# Wiring Requirements



## WARNING

### **Safety First!**

Be sure to disconnect the power cord before installing and/or wiring your Moxa VPort 461.

Calculate the maximum possible current in each power wire and common wire. Observe all electrical codes dictating the maximum allowable current for each wire size.

If the current goes above the maximum ratings, the wiring could overheat, causing serious damage to your equipment.

You should also pay attention to the following items:

- Use separate paths to route wiring for power and devices. If power wiring and device wiring paths must cross, make sure the wires are perpendicular at the intersection point.  
**NOTE:** Do not run signal or communications wiring and power wiring in the same wire conduit. To avoid interference, wires with different signal characteristics should be routed separately.
- You can use the type of signal transmitted through a wire to determine which wires should be kept separate. The rule of thumb is that wiring that shares similar electrical characteristics can be bundled together.
- Keep input wiring and output wiring separated.
- It is strongly advised that you label wiring to all devices in the system.

## Grounding the Moxa VPort 461

Grounding and wire routing help limit the effects of noise due to electromagnetic interference (EMI). Run the ground connection from the ground screw to the grounding surface prior to connecting devices.



## ATTENTION

This product is intended to be mounted to a well-grounded mounting surface, such as a metal panel.

# Wiring the Redundant Power Inputs

The VPort 461 has two sets of power input, power input 1 and power input 2, which are located on the 6-pin and 8-pin terminal block connectors. Top and front views of the terminal block connectors are shown here.

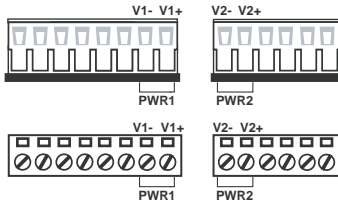

**STEP 1:** Insert the negative/positive DC or AC wires into the V-/V+ terminals.

**STEP 2:** To keep the DC or AC wires from pulling loose, use a small flat-blade screwdriver to tighten the wire-clamp screws on the front of the terminal block connector.

**STEP 3:** Insert the plastic terminal block connector prongs into the terminal block receptor, which is located on the VPort 461's top panel.



## ATTENTION

The power for this product is intended to be supplied by a Listed Power Unit, with output marked LPS, and rated to deliver 12 to 32 VDC at a maximum of 450 mA (at 12VDC), or 18 to 30 VAC at a maximum of 550 mA (at 18VAC). The maximum power consumption is 5.5W.



## ATTENTION

Before connecting the VPort to the AC/DC power inputs, make sure the DC power source voltage is stable.

# Wiring the Relay Output

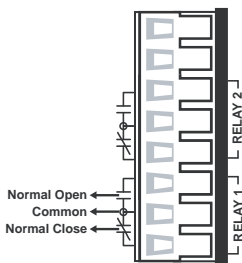

The VPort 461 has two sets of relay output, relay 1 and relay 2, which are located on the 8-pin terminal block connector. Each relay output consists of the 3 contacts of the terminal block on the VPort 461's top panel.

The relay output can be set up for:

1. System alarm: Power failure, Video loss and Network disconnected.
2. Event alarm: VMD (Video Motion Detection) and Digital Inputs (firmware version V2.0 and later)



## ATTENTION

The current and power capacity of the relay output is a maximum of 24 VDC @ 1A. You should be careful not to exceed this power specification.

## Wiring the Digital Inputs

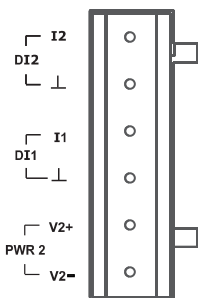

VPort 461 has four sets of digital input, DI1, DI2, DI3 and DI4. Each DI consists of two contacts of the 10-pin terminal block connector on VPort's top panel. Top and front views of one of the terminal block connectors are shown here.

**STEP 1:** Insert the negative (ground)/positive DI wires into the  $\perp$ /I1 terminals.

**STEP 2:** To keep the DI wires from pulling loose, use a small flat-blade screwdriver to tighten the wire-clamp screws on the front of the terminal block connector.

**STEP 3:** Insert the plastic terminal block connector prongs into the terminal block receptor, which is located on VPort 461's top panel.

## Communication Connections

VPort 461 models have one RJ45 console port (RS-232 interface), and 2 10/100BaseT(X) Ethernet port or 1 100BaseFX (SC-type connector) fiber port.

### RS-232 Console Port Connection

VPort 461 has one RS-232 (10-pin RJ45) console port, located on the top panel. Use either an RJ45-to-DB9 or RJ45-to-DB25 cable (see the cable following wiring diagrams) to connect VPort 461's console port to your PC's COM port.

You may then use a console terminal program, such as the Moxa PComm Terminal Emulator, to access VPort 461's console configuration utility.

#### RJ45 (10-pin) Console Port Pinouts

Pin	Description
1	---
2	DSR
3	---
4	GND
5	TxD
6	RxD
7	GND
8	---
9	DTR
10	---

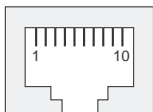



# 10/100BaseT(X) Ethernet Port Connection

The 10/100BaseT(X) port located on the VPort 461's front panel is used to connect to Ethernet-enabled devices.

Pinouts for both MDI (NIC-type) ports and MDI-X (HUB/Switch-type) ports are illustrated below, along with cable wiring diagrams for straight-through and cross-over Ethernet cables.

The 10/100BaseT(X) port of the VPort 461 is an MDI port, which means that you should use a cross-over Ethernet cable to connect to the MDI NIC port, and a straight-through Ethernet cable to connect to the MDI-X HUB/Switch port.

## MDI Port Pinouts

Pin	Signal
1	Tx+
2	Tx-
3	Rx+
6	Rx-

## MDI-X Port Pinouts

Pin	Signal
1	Rx+
2	Rx-
3	Tx+
6	Tx-

## 8-pin RJ45

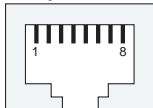

### RJ45 (8-pin) to RJ45 (8-pin) Straight-Through Cable Wiring

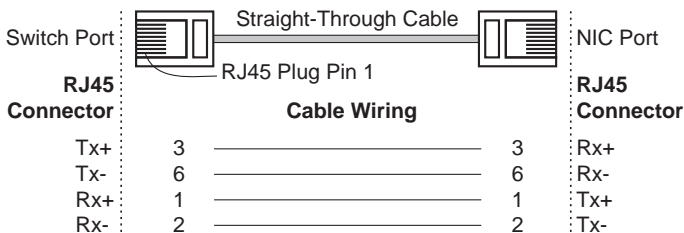

### RJ45 (8-pin) to RJ45 (8-pin) Cross-Over Cable Wiring

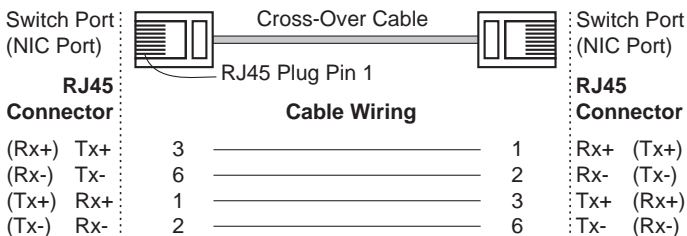

# 100BaseFX Ethernet Port Connection

The concept behind the SC port and cable is quite straightforward. Suppose that you are connecting devices I and II. Contrary to electrical signals, optical signals do not require a circuit in order to transmit data. Consequently, one fiber optic cable is used to transmit data from device I to device II, and the other fiber optic cable is used to transmit data from device II to device I, for full-duplex transmission.

Remember to connect the Tx (transmit) port of device I to the Rx (receive) port of device II, and the Rx (receive) port of device I to the Tx (transmit) port of device II. If you make your own cable, we suggest labeling the two sides of the same line with the same letter (A-to-A and B-to-B, as shown below, or A1-to-A2 and B1-to-B2).

## SC-Port Pinouts

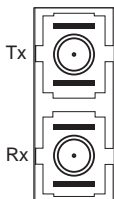

## SC-port to SC-port Cable Wiring

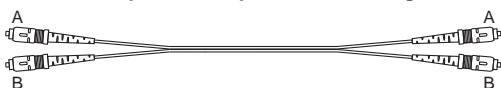

### Cable Wiring

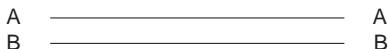

## COM Port

A COM PORT is located on the front panel for connecting a PTZ motorized camera or serial device. The COM port transmits RS-232 or RS-422/485 signals over the TCP/IP network. Users can use this COM port (DB9 male connector) to monitor data or control a serial device, or for the control of a PTZ motorized camera.

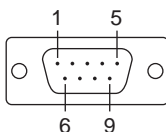

### RS-232/422/485 (Male DB9) Pinouts

PIN	RS-232	RS-422 4-wire RS-485	RS-485 2-wire
1	DCD	TxD-(A)	---
2	RXD	TxD+(B)	---
3	TXD	RxD+(B)	Data+(B)
4	DTR	RxD-(A)	Data-(A)
5	GND	GND	GND
6	DSR	---	---
7	RTS	---	----
8	CTS	---	---
9	---	---	---

**NOTE** This COM port is mainly for the serial-to-Ethernet connectivity. Currently, it is supported with Real COM, TCP Server and TCP Client modes.

## PTZ port

A PTZ port is located on the VPort 461's front panel. The port is used to connect a PTZ motorized camera or device so that the camera or device can be controlled from the VPort over the IP network. The PTZ port supports RS-232 or RS-422/485 signals through a terminal block. The PTZ port pin assignments are shown in the following table.



PIN	RS-422/485	RS-232
1	GND	GND
2	R-	---
3	R+	RxD
4	T-\D-	---
5	T+\D+	TxD

## SD Card Slot

The front panel of Moxa's VPort 461 has an SD card slot that supports the SDHC interface. An SD card can be used for recording video if the network is down.



SD card slot with upper case



SD card slot without upper case

**STEP 1:** Open the upper case of the SD card slot.

**STEP 2:** Plug the SD card into the slot. Then the SD LED indicator will flash in Green.

**STEP 3:** When the SD card is mounted successfully, the SD LED indicator will light in green after 2 to 3 seconds. If the SD card mount fails, then the SD LED indicator will continuously flash in Green. If this happens, repeat the above until the SD LED indicator light turns green.

**STEP 4:** Close the upper case and then go to the web-based manager to set up local storage functions.

**NOTE** Currently, the SDHC interface can support an SD card with up to 32 GB of storage space.

**NOTE** Follow these steps to remove the SD card:

**Step1:** Open the upper case.

**Step2:** Wait a few seconds to allow the SD card to complete existing file storing activity.

**Step3:** If the SD LED indicator is lighted in green, it means the unmounting of the SD card was successful, and you can take out the SD card. If the SD LED indicator flashes in green, it means the unmounting of the SD card failed. At this point, you can take out the SD card. But you will need to reboot the VPort 461 to enable the SD card slot function for future SD cards.

## LED Indicators

The front panel of Moxa's VPort 461 contains several LED indicators. The function of each LED is described in the table below.

LED	Color	State	Description
STAT	Green/ Red	Steady Red	Hardware initialization stage.
		Flashing Red	Software initialization stage.
		Steady Green	System is powered on and ready to run.
		Flashing Green	Firmware is being upgraded.
PWR1	AMBER	On	Power is being supplied through power input PWR1.
		Off	Power is <b>not</b> being supplied through power input PWR1.
PWR2	AMBER	On	Power is being supplied through power input PWR2.
		Off	Power is <b>not</b> being supplied through power input PWR2.
FAULT	RED	On	One of the following 3 conditions is met: <ul style="list-style-type: none"> <li>➤ One of the 2 power inputs is disconnected.</li> <li>➤ Video loss.</li> <li>➤ Network disconnected.</li> </ul> Users can configure these alarm settings on the system alarm page of system configuration.
		Off	Both power inputs are connected and are working properly, or the alarm is activated, there is no video loss and the network is connected.
VIDEO	GREEN	On	Video signal is detected.
		Off	Video signal is not detected.
PTZ	GREEN	On	Serial data in COM port or PTZ port is transmitting.

		Off	No serial data is transmitting.
SD	GREEN	On	SD card is mounted correctly and is ready to use.
		Flash	Error in mounting SD card.
		Off	No SD card in the slot.

## Hardware Reset

A recessed RESET button is provided for restoring the system to the factory default settings. When the system fails to install properly, or operates abnormally, use the RESET button located on the top panel of the VPort 461 to restore the factory defaults.

To do this, use a pointed object such as a straightened paper clip or toothpick, to depress the reset button continuously. Release the reset button when the STAT LED stops flashing in red. At this point, the POST process will run, and the VPort will reboot. The STAT LED will light in green when the VPort has finished rebooting.

## Specifications

Video				
Video Compression	H.264 (MPEG4 Part 10, AVC), MJPEG			
Video Streams	3 (2 H.264 and 1 MJPEG)			
Video Inputs	1, BNC connector (1 Vpp, 75 ohms)			
Video Latency	Under 200 ms			
NTSC/PAL	Auto-sensing or manual			
Video Resolution and FPS (frames per second):				
	NTSC		PAL	
	Size	Max. FPS	Size	Max. FPS
QCIF	176 x 112	30	176 x 144	25
CIF	352 x 240	30	352 x 288	25
VGA	640 x 480	30	640 x 480	25
4CIF	704 x 480	30	704 x 576	25
Full D1	720 x 480	30	720 x 576	25
Video Viewing	<ul style="list-style-type: none"> <li>Adjustable image size and quality</li> <li>Timestamp and text overlay</li> </ul>			
Audio				
Audio Input	1 Line-in or MIC-in, 3.5mm phone jack connector			
Audio Output	1 Line-out, 3.5mm phone jack connector			
Network				
Protocols	TCP, UDP, HTTP, SMTP, FTP, Telnet, NTP, DNS, DHCP, UPnP, RTP, RTSP, ICMP, IGMPv3, QoS (ToS), SNMP (V1/V2c/V3), DDNS, Modbus/TCP			
Ethernet	2 10/100BaseT(X) auto negotiation speed RJ45 port, or 1 100BaseFX fiber port (SC connector)			

<b>Optical Fiber:</b>		
	<b>100BaseFX</b>	
	<b>Multi Mode</b>	<b>Single Mode</b>
<b>Wavelength</b>	1300 nm	1310 nm
<b>Max. TX</b>	-10 dBm	0 dBm
<b>Min. TX</b>	-20 dBm	-5 dBm
<b>RX Sensitivity</b>	-32 dBm	-34 dBm
<b>Link Budget</b>	12 dB	29 dB
<b>Typical Distance</b>	5 km <sup>a</sup> 4 km <sup>b</sup>	40 km <sup>c</sup>
<b>Saturation</b>	-6 dBm	-3 dBm
a. 50/125µm, 800 MHz*km fiber optic cable		
b. 62.5/125µm, 500 MHz*km fiber optic cable		
c. 9/125µm, 3.5 PS/(nm*km) fiber optic cable		
<b>Serial Port</b>		
COM port	1 RS-232 or RS-422/485 port, DB9 male connector, 115.2 Kbps max. baudrate, with 15 KV ESD protection	
PTZ port	1 port, RS-232 or RS-422/485 terminal block connector, 115.2 Kbps max. baudrate, with 15 KV ESD protection	
Console port	1 RS-232 RJ45 port	
<b>GPIO</b>		
Digital Inputs	2, max. 8 mA High: +13V to +30V Low: -30V to +3V	
Relay Output	2 (max. 24 VDC @ 1A)	
<b>LED Indicators</b>		
STAT	Indicates if system has booted up properly	
PWR1	Power 1	
PWR2	Power 2	
FAULT	Can be configured for system alarm, power failure, video loss, or network down.	
VIDEO	Video input signal active	
PTZ	PTZ or COM port data is transmitted or not	
SD	SD card mounting or unmounting in successful or not	
<b>Power</b>		
Inputs	2 12/24 VDC or 24 VAC for redundancy	
Consumption	Approximately 5.5W	
<b>Mechanical</b>		
Casing	IP30 protection, metal case	
Dimensions (W x D x H)	52.98 x 135 x 105 mm (2.09 x 5.31 x 4.13 in)	
Weight	900 g	
Installation	DIN-Rail or wall mounting	

<b>Environmental</b>	
Operating Temperature	0 to 60°C (32 to 140°F) -40 to 75°C (-40 to 167°F) for -T models
Storage Temperature	-40 to 85°C (-40 to 185°F)
Ambient Relative Humidity	5 to 95% (non-condensing)
<b>Regulatory Approvals</b>	
Safety	UL 508 (Pending)
EMI	FCC Part 15, CISPR (EN55022) class A
EMS	EN61000-4-2 (ESD), Level 2 EN61000-4-3 (RS), Level 3 EN61000-4-4 (EFT), Level 3 EN61000-4-5 (Surge), Level 3 EN61000-4-6 (CS), Level 3 EN61000-4-8 EN61000-4-11
Shock	IEC60068-2-27
Freefall	IEC60068-2-32
Vibration	IEC60068-2-6
<b>Warranty</b>	5 years

<b>Alarm Features</b>
<ul style="list-style-type: none"> <li>• Video Motion detection with sensitivity tuning (firmware version V2.0 and later)</li> <li>• Video loss alarm.</li> <li>• Daily repeat timing schedule.</li> <li>• JPEG snapshots for pre/trigger/post alarm images.</li> <li>• Automatic transfer of stored images via email or FTP with event-triggered actions.</li> <li>• HTTP event servers and CGI commands for setting customized alarm actions.</li> </ul>

<b>PAN/TILT/ZOOM</b>
<ul style="list-style-type: none"> <li>• PTZ camera is controlled through RS-232/422/485.</li> <li>• PTZ Control Functions: PAN, TILT, ZOOM, FOCUS, moving speed, preset position (max. 25 positions), and 24 custom commands.</li> <li>• Supported devices and protocols: Dynacolor DynaDome, Pelco D-protocol, Pelco P, Yokogawa Fieldeye series, Cohu, Custom Camera.</li> <li>• PTZ driver upload.</li> <li>• Transparent PTZ Control for controlling the PTZ camera with legacy PTZ control panel or keyboard.</li> </ul>

<b>Security</b>
<ul style="list-style-type: none"> <li>• User level password protection</li> <li>• IP address filtering</li> </ul>

<b>Recommended Minimum Viewing System Requirements</b>
<ul style="list-style-type: none"> <li>• Pentium 4, 2.4 GHz</li> <li>• 512 MB memory</li> <li>• Windows XP/2000 with SP4</li> </ul>

<ul style="list-style-type: none"> <li>• Internet Explorer 6.x</li> <li>• DirectX 9.0c</li> </ul>	
<b>Software Bundled Free</b>	
VPort SDK PLUS	Includes CGI commands and ActiveX Control for customized applications or system integration for third-party developers

### Technical Support Contact Information

**[www.moxa.com/support](http://www.moxa.com/support)**

**Moxa Americas:**

Toll-free: 1-888-669-2872  
 Tel: +1-714-528-6777  
 Fax: +1-714-528-6778

**Moxa China (Shanghai office):**

Toll-free: 800-820-5036  
 Tel: +86-21-5258-9955  
 Fax: +86-10-6872-3958

**Moxa Europe:**

Tel: +49-89-3 70 03 99-0  
 Fax: +49-89-3 70 03 99-99

**Moxa Asia-Pacific:**

Tel: +886-2-8919-1230  
 Fax: +886-2-8919-1231