

# DA-820C Series Embedded Computer User's Manual

---

Version 1.0, August 2019

[www.moxa.com/product](http://www.moxa.com/product)

**MOXA**<sup>®</sup>

© 2019 Moxa Inc. All rights reserved.

# DA-820C Series Embedded Computer User's Manual

The software described in this manual is furnished under a license agreement and may be used only in accordance with the terms of that agreement.

## Copyright Notice

© 2019 Moxa Inc. All rights reserved.

## Trademarks

The MOXA logo is a registered trademark of Moxa Inc.  
All other trademarks or registered marks in this manual belong to their respective manufacturers.

## Disclaimer

Information in this document is subject to change without notice and does not represent a commitment on the part of Moxa.

Moxa provides this document as is, without warranty of any kind, either expressed or implied, including, but not limited to, its particular purpose. Moxa reserves the right to make improvements and/or changes to this manual, or to the products and/or the programs described in this manual, at any time.

Information provided in this manual is intended to be accurate and reliable. However, Moxa assumes no responsibility for its use, or for any infringements on the rights of third parties that may result from its use.

This product might include unintentional technical or typographical errors. Changes are periodically made to the information herein to correct such errors, and these changes are incorporated into new editions of the publication.

## Technical Support Contact Information

[www.moxa.com/support](http://www.moxa.com/support)

### **Moxa Americas**

Toll-free: 1-888-669-2872  
Tel: +1-714-528-6777  
Fax: +1-714-528-6778

### **Moxa Europe**

Tel: +49-89-3 70 03 99-0  
Fax: +49-89-3 70 03 99-99

### **Moxa India**

Tel: +91-80-4172-9088  
Fax: +91-80-4132-1045

### **Moxa China (Shanghai office)**

Toll-free: 800-820-5036  
Tel: +86-21-5258-9955  
Fax: +86-21-5258-5505

### **Moxa Asia-Pacific**

Tel: +886-2-8919-1230  
Fax: +886-2-8919-1231

# Table of Contents

<b>1. Introduction</b>	<b>1-1</b>
Overview	1-2
Model Descriptions and Package Checklist	1-2
Appearance	1-4
Dimensions	1-5
Features	1-5
Hardware Block Diagram	1-6
DA-820C Basic System	1-6
Hardware Specifications	1-6
<b>2. Hardware Installation</b>	<b>2-1</b>
Installing Rackmount Ears	2-2
Wiring Requirements	2-3
Connecting the Power	2-4
Wiring the Power Inputs	2-4
Grounding the Chassis	2-5
Power Wiring Methods	2-5
Reset Button	2-6
LED	2-7
Connecting to Displays	2-7
Connecting USB Devices	2-8
Installing a USB Dongle Kit	2-9
Serial Ports	2-9
Gigabit LAN Ports	2-10
Digital Inputs/Digital Outputs	2-11
Relay Output	2-11
Upgrading the Memory Module	2-12
Installing an mSATA Storage Card	2-13
Installing SATA Hard Disks	2-14
Installing the Expansion Module	2-16
Inserting the PCIe/PCI Modules	2-17
<b>3. BIOS Setup</b>	<b>3-1</b>
Entering the BIOS Setup	3-2
Main Page	3-4
Advanced Settings	3-5
Boot Configuration	3-6
SATA Configuration	3-6
Intel Rapid Storage Technology	3-8
CPU Configuration	3-9
Active Management Technology Support	3-10
Video Configuration	3-11
Chipset Configuration	3-14
SIO ITE8786E	3-15
Console Redirection	3-16
Security Settings	3-17
Current TPM Device	3-17
TPM State	3-17
Clear TPM	3-17
Set Supervisor Password	3-18
Power Settings	3-19
Wake on LAN	3-19
Auto Wake on S5	3-19
Power On USB3 (Rear)	3-19
Power On USB2 (Front)	3-20
Power On USB2 (Internal)	3-20
PS/2 Keyboard Power-Up	3-20
Boot Settings	3-20
Boot Type	3-21
Network Stack	3-21
PXE Boot capability	3-21
Timeout	3-21
EFI	3-21
Exit Settings	3-21
Exit Saving Changes	3-22
Save Change Without Exit	3-22
Exit Discarding Changes	3-22
Load Optimal Defaults	3-22
Load Custom Defaults	3-22
Save Custom Defaults	3-23

Discard Changes .....	3-23
Enable AMT .....	3-23
Use AMT .....	3-26
Upgrading the BIOS .....	3-28
<b>A. Safety Installation Instructions .....</b>	<b>A-1</b>

## Introduction

---

Thank you for purchasing a Moxa DA-820C industrial computer, a multi-functional embedded computer designed especially for IEC 61850-3 substation automation systems.

This manual covers hardware installation, connector interfaces, and BIOS setup of the DA-820C. For software configuration and management, please refer to the user's manual for your operating system.

The following topics are covered in this chapter:

- ❑ **Overview**
- ❑ **Model Descriptions and Package Checklist**
- ❑ **Appearance**
- ❑ **Dimensions**
- ❑ **Features**
- ❑ **Hardware Block Diagram**
  - DA-820C Basic System
- ❑ **Hardware Specifications**

# Overview

The DA-820C computer's main operating system is based on the Intel® Core™ i3, i5, i7 or Xeon CPU. The computer comes with 3 display ports (2 x HDMI + 1 x VGA), 5 USB ports, 4 Gigabit LAN ports, 2 3-in-1 RS-232/422/485 serial ports, 6 digital input ports and 2 digital output ports. The DA-820C is equipped with 4 hot-swappable 2.5" HDD/SSD slots and supports Intel® RST RAID 0/1/5/10 functionality. In addition, the DA-820C comes with 5 standard PCI/PCIe slots, allowing users to install various peripheral interface expansions modules.

With IEC 61850-3 and IEEE 1613 compliance, the DA-820C is sure to deliver stable and reliable system operation for power applications. The DA-820C also complies with the IEC 60255 standards, which cover the protection of electrical relays in a smart substation. IEC 60255 is one of the most widely used standards for testing relays and protection equipment, and compliance with the standard ensures that the DA-820C will work reliably and seamlessly with IEDs as part of a robust substation automation system.

EN 50121-4 compliance confirms that the DA-820C can deliver stable and reliable system operations in rail wayside applications, such as station SCADA systems, wayside disaster prevention, traction power, and signaling and safety systems to provide an integrated view of your smart rail setup.

This robust, rack-mountable design provides the hardened protection needed for industrial environment applications.

## Model Descriptions and Package Checklist

The DA-820C Series includes the following models:

- **DA-820C-KL3-H-T:** Intel® Core™ i3-7102E, 2C/2T, 2.1 GHz CPU, with 2x HDMI, 1x VGA, 4 Gigabit LAN ports, 2 RS/232/422/485 3-in-1 serial port, 2 PS/2, 6 DI, 2 DO, 1 mSATA, 4 SATA, 5 USB, without RAM, mSATA and OS, single power -40 to 70°C temp.
- **DA-820C-KL3-HH-T:** Intel® Core™ i3-7102E, 2C/2T, 2.1 GHz CPU, with 2x HDMI, 1x VGA, 4 Gigabit LAN ports, 2 RS/232/422/485 3-in-1 serial port, 2 PS/2, 6 DI, 2 DO, 1 mSATA, 4 SATA, 5 USB, without RAM, mSATA and OS, dual power -40 to 70°C temp.
- **DA-820C-KL5-H-T:** Intel® Core™ i5-7442EQ, 4C/4T, 2.1 GHz CPU, with 2x HDMI, 1x VGA, 4 Gigabit LAN ports, 2 RS/232/422/485 3-in-1 serial port, 2 PS/2 and 6 DI, 2 DO, 1 mSATA, 2 SATA, 5 USB, without RAM, mSATA and OS, single power -40 to 70°C temp.
- **DA-820C-KL5-HH-T:** Intel® Core™ i5-7442EQ, 4C/4T, 2.1 GHz CPU, with 2x HDMI, 1x VGA, 4 Gigabit LAN ports, 2 RS/232/422/485 3-in-1 serial port, 2 PS/2 and 6 DI, 2 DO, 1 mSATA, 2 SATA, 5 USB, without RAM, mSATA and OS, dual power -40 to 70°C temp.
- **DA-820C-KLXL-H-T:** Intel® Core™ Xeon E3-1505LV6, 4C/8T, 3 GHz CPU, with 2x HDMI, 1x VGA, 4 Gigabit LAN ports, 2 RS/232/422/485 3-in-1 serial port, 2 PS/2 and 6 DI, 2 DO, 1 mSATA, 2 SATA, 5 USB, without RAM, mSATA and OS, single power -40 to 70°C temp.
- **DA-820C-KLXL-HH-T:** Intel® Core™ Xeon E3-1505L V6, 4C/8T, 3 GHz CPU, with 2x HDMI, 1x VGA, 4 Gigabit LAN ports, 2 RS/232/422/485 3-in-1 serial port, 2 PS/2 and 6 DI, 2 DO, 1 mSATA, 2 SATA, 5 USB, without RAM, mSATA and OS, dual power -40 to 70°C temp.
- **DA-820C-KL7-H:** Intel® Core™ i7-7820EQ, 4C/8T, 3 GHz CPU, with 2x HDMI, 1x VGA, 4 Gigabit LAN ports, 2 RS/232/422/485 3-in-1 serial port, 2 PS/2 and 6 DI, 2 DO, 1 mSATA, 2 SATA, 5 USB, without RAM, mSATA and OS, single power -25 to 55°C temp.
- **DA-820C-KL7-HH:** Intel® Core™ i7-7820EQ, 4C/8T, 3 GHz CPU, with 2x HDMI, 1x VGA, 4 Gigabit LAN ports, 2 RS/232/422/485 3-in-1 serial port, 2 PS/2 and 6 DI, 2 DO, 1 mSATA, 2 SATA, 5 USB, without RAM, mSATA and OS, dual power -25 to 55°C temp.

- **DA-820C-KLXM-H:** Intel® Core™ Xeon E3-1505MV6, 4C/8T, 3 GHz CPU, with 2x HDMI, 1x VGA, 4 Gigabit LAN ports, 2 RS/232/422/485 3-in-1 serial port, 2 PS/2 and 6 DI, 2 DO, 1 mSATA, 2 SATA, 5 USB, without RAM, mSATA and OS, single power -25 to 55°C temp.
- **DA-820C-KLXM-HH:** Intel® Core™ Xeon E3-1505M V6, 4C/8T, 3 GHz CPU, with 2x HDMI, 1x VGA, 4 Gigabit LAN ports, 2 RS/232/422/485 3-in-1 serial port, 2 PS/2 and 6 DI, 2 DO, 1 mSATA, 2 SATA, 5 USB, without RAM, mSATA and OS, dual power -25 to 55°C temp.

**NOTE** To order a DA-820C system with preinstalled Debian 9 or Windows 10 Enterprise LTSC 64-bit OS, contact a Moxa sales representative.

Each model ships with following additional items:

- DA-820C rackmount computer
- Rackmount kit
- Quick Installation Guide (printed)
- Warranty card

**Standard PCIe Interface Modules**

- **DA-PRP-HSR:** 2-port Gigabit Ethernet expansion module compliant with IEC62439-3 protocol for Moxa DA-820 series industrial computers
- **DE-GX02-SFP-T:** 2-port 1000 Mbps fiber card, SFP slot x 2, PCIe interface (SFP module excluded)
- **DE-FX02-SFP-T:** 2-port 100 Mbps fiber card, SFP slot x 2, PCIe interface (SFP module excluded)
- **DA-IRIG-B-S-02-T:** IRIG-B expansion module, PCI interface, 1 fiber IRIG-B in, 1 DB9M in/out, 1 DB9M out



**ATTENTION**

Additional expansion modules are currently under development.

# Appearance

## Front View

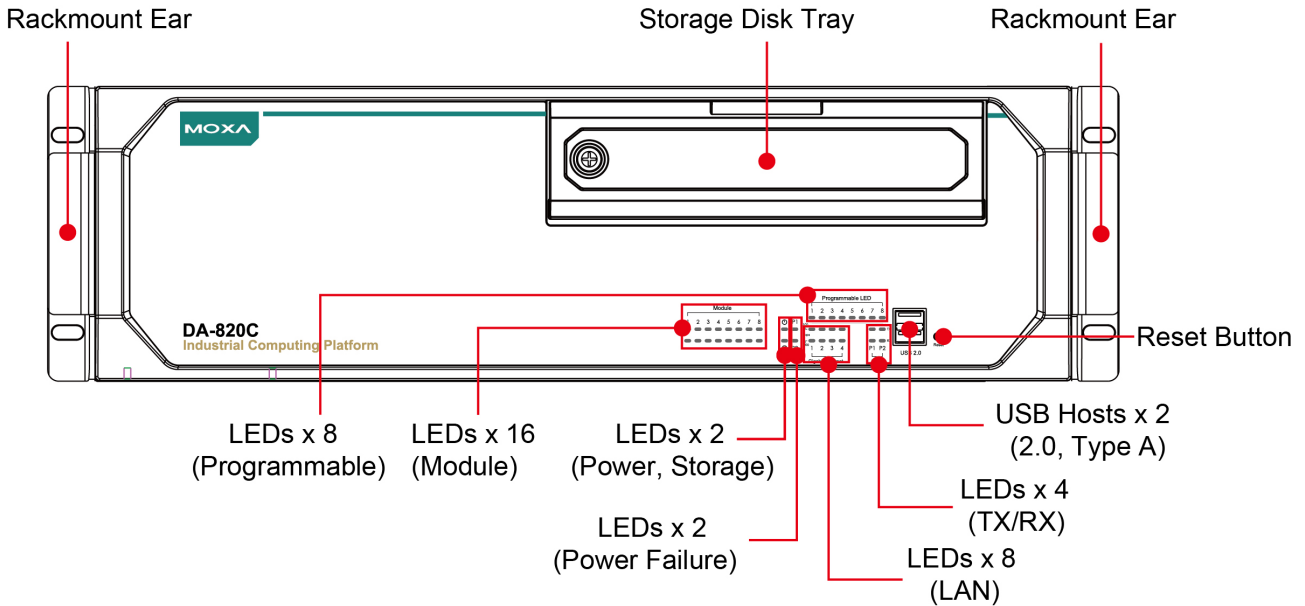

## Rear View

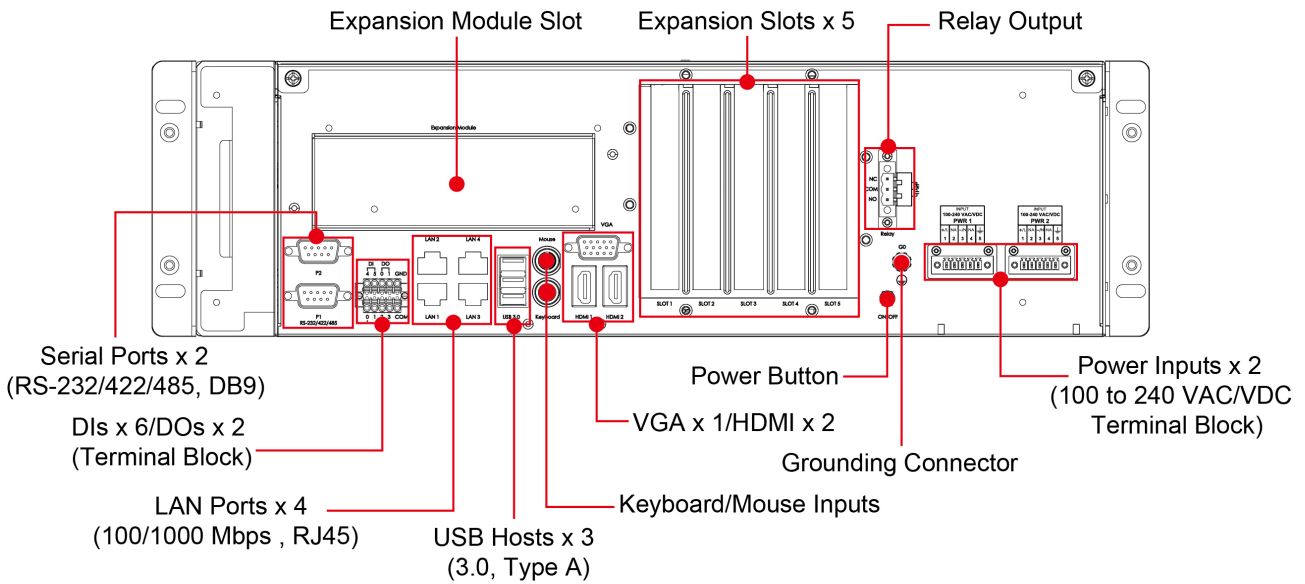



## Dimensions

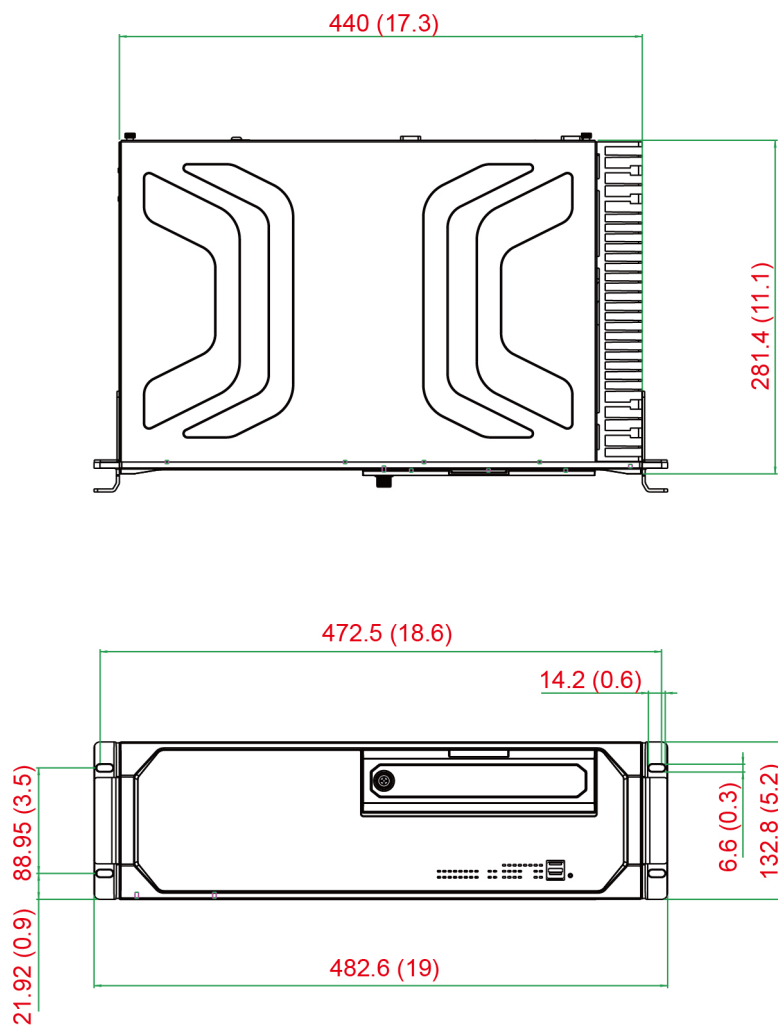

Unit = mm (inch)

## Features

The DA-820C computer has the following features:

- 7th Gen Intel® Core™ CPU (Kaby Lake)
- 2 built-in DDR4 memory socket, up to total 32GB capacity
- 2 x USB 2.0 and 3 x USB 3.0 type A ports for high-speed peripherals
- 1 PCIe x16, 1 PCIe x4, 2 PCIe x1 slots and 1 PCI slots for expansion modules
- 4 x hot swappable 2.5" HDD/SSD slots, supported by Intel® RST RAID 0/1/5/10
- Highly reliable design, supporting dual power and PRP/ HSR technology (with PRP/HSR expansion module)
- IEC 61850-3, IEEE 1613, and IEC 60255 compliant for power substation automation systems
- EN 50121-4 compliant for railway wayside applications
- 2 x HDMI (v1.4) + 1x VGA
- 6 x DI/ 2 x DO and alarm relay

# Hardware Block Diagram

## DA-820C Basic System

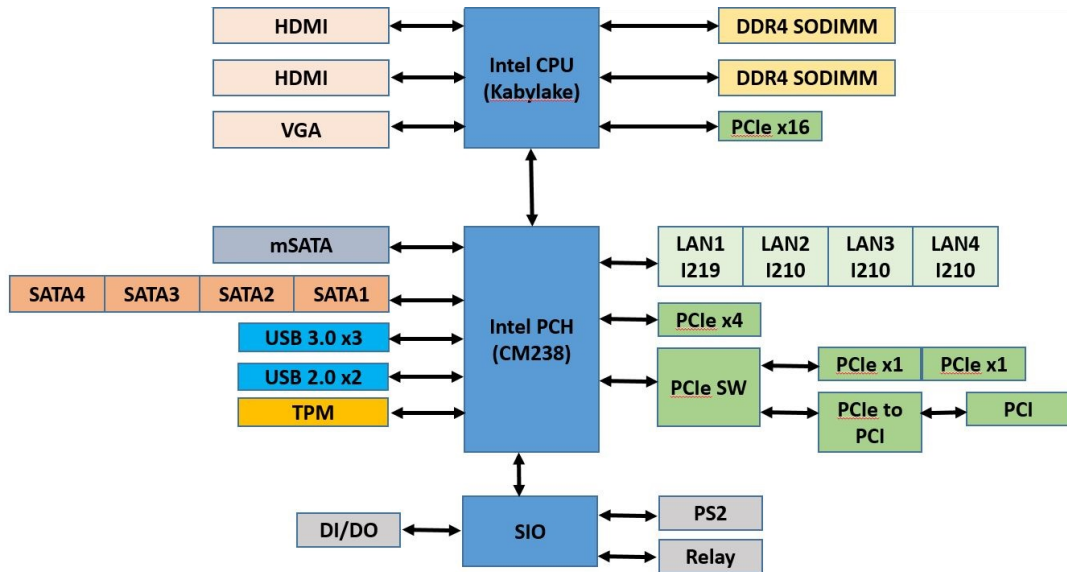

## Hardware Specifications

**NOTE** The latest specifications for Moxa’s products can be found at <https://moxa.com>.

# Hardware Installation

---

The DA-820C embedded computers are compact and rugged, making them suitable for industrial applications. The LED indicators allow users to monitor performance and identify trouble spots quickly, and multiple ports are provided for connecting a variety of different devices. The DA-820C embedded computers come with a reliable and stable hardware platform that lets you devote the bulk of your time to application development. This chapter describes hardware installation and connector interfaces of the DA-820C embedded computers.

The following topics are covered in this chapter:

- ❑ **Installing Rackmount Ears**
- ❑ **Wiring Requirements**
- ❑ **Connecting the Power**
- ❑ **Wiring the Power Inputs**
  - Grounding the Chassis
  - Power Wiring Methods
- ❑ **Reset Button**
- ❑ **LED**
- ❑ **Connecting to Displays**
- ❑ **Connecting USB Devices**
  - Installing a USB Dongle Kit
- ❑ **Serial Ports**
- ❑ **Gigabit LAN Ports**
- ❑ **Digital Inputs/Digital Outputs**
- ❑ **Relay Output**
- ❑ **Upgrading the Memory Module**
- ❑ **Installing an mSATA Storage Card**
- ❑ **Installing SATA Hard Disks**
- ❑ **Installing the Expansion Module**
- ❑ **Inserting the PCIe/PCI Modules**

# Installing Rackmount Ears

The DA-820C computer comes with two Rackmount Ear Kits that allow users to install the computer on a rack. The Rackmount Ear Kit includes the following items.

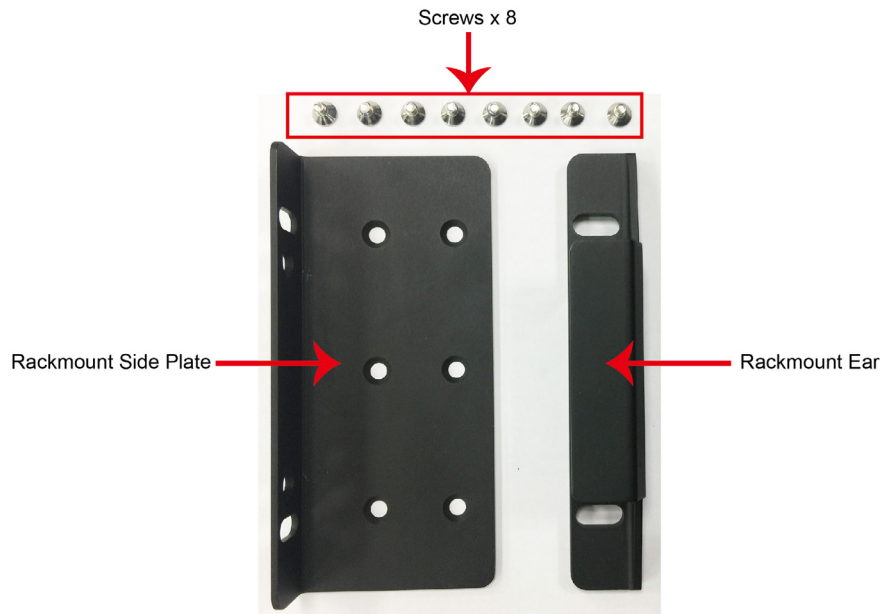

Follow these steps for the installation.

1. Attach the rackmount ear to the side plate, and fasten two screws tightly.

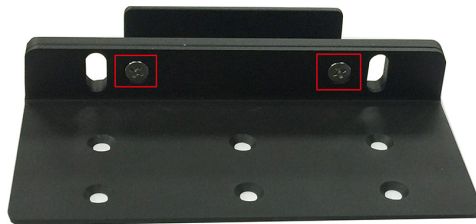

2. Attach the side plate on one side of the DA-820C computer, and fasten six screws tightly.

3. Use the same method to install another Rackmount Ear Kit and attach to the other side of the computer.



# Wiring Requirements

The following common safety precautions should be observed before installing any electronic device:

- Power wires and communication/signal wires should be routed through separate paths. If power and communication/signal wires must cross paths, make sure the wires are perpendicular at the intersection point.  
**NOTE:** Do not run signal or communication wiring and power wiring in the same wire conduit. To avoid interference, wires with different signal characteristics should be routed separately.
- Use the type of signal transmitted through a wire to determine which wires should be bundled together and which kept separate. The rule of thumb is that wiring that carries similar electrical signals can be bundled together.
- When necessary, we strongly advise labeling the wiring for all devices in the system.



## ATTENTION

Do not run signal or communication wiring and power wiring in the same wire conduit. To avoid interference, wires with different signal characteristics should be routed separately.



## ATTENTION

### Safety First!

Be sure to disconnect the power cord before installing and/or wiring your device.

### Electrical Current Caution!

Calculate the maximum possible current in each power wire and common wire. Observe all electrical codes dictating the maximum current allowable for each wire size.

If the current goes above the maximum rating, the wiring could overheat, causing serious damage to your equipment.

### Temperature Caution!

Be careful when handling the unit. When the unit is plugged in, the internal components generate heat, and consequently the outer casing may feel hot to the touch.



## Restricted Access Location

This equipment is intended to be used in Restrict Access Location, like computer room. The access can only be gained by SERVICE PERSONS or by USERS who have been instructed about the metal chassis of the equipment is so hot that service persons have to pay special attention or take special protection before touching it. Further, the access is through the use of key or security identity system. Only authorized by well trained professional person can access the restrict access location.



External metal parts are hot!! Before touching it, special attention or protection is necessary.

# Connecting the Power

The DA-820C provides dual power inputs using a terminal block, which is located on the rear panel. Connect the power cord wires to the screws, and then tighten the screws. The Power LED will light up to indicate that power is being supplied to the DA-820C, after which the BIOS will initialize the flash disk module, causing the Storage LED to blink. It should take about 30 to 60 seconds for the operating system to complete the boot up process.

## Wiring the Power Inputs

Refer to the following diagrams and table for a detailed description of the power input wiring. The terminal numbers referred to in the table are shown in the diagrams below.

**NOTE** The Power LED on the front panel will turn on if the computer is losing power. For details on the behavior of the Power LED, refer the *LED* section in the chapter.

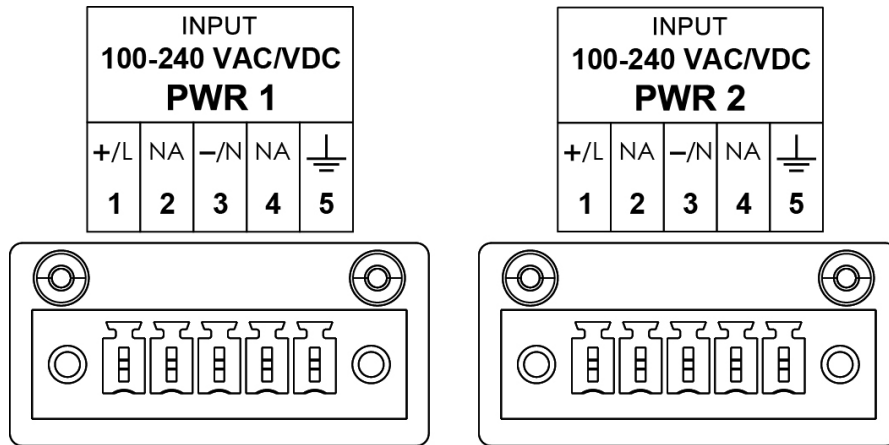

Terminal Number	Description	Note
1	Power Line	<b>PWR Line</b> is connected to the <b>Line (L)</b> terminal for the AC power source.
	Power Positive	<b>PWR Positive</b> is connect to the <b>+</b> terminal for the DC power source
2	NA	No function
3	Power Neutral	<b>PWR Neutral</b> is connected to the <b>Neutral (N)</b> terminal for the AC power source.
	Power Negative	<b>PWR Negative</b> is connect to the <b>-</b> terminal for the DC Power
4	NA	No function
5	Bond Earth	<b>Bond Earth</b> is connected to the <b>Chassis Ground</b> via a jumper on the terminal block.

## Grounding the Chassis

There is a grounding connector located on the rear panel of the computer.

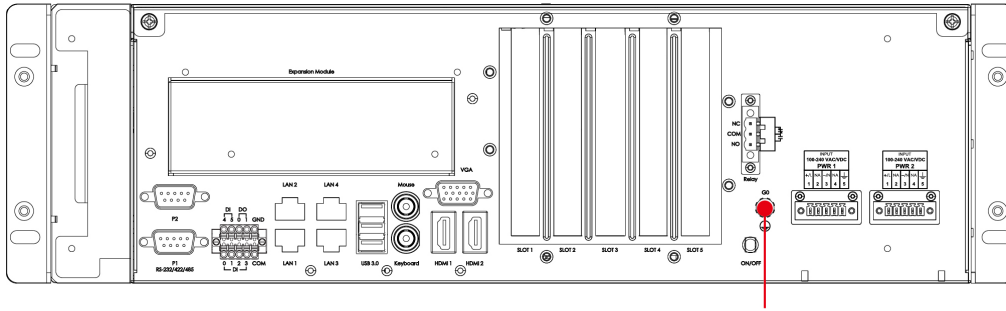

Grounding Connector

Connect the connector to the chassis ground source.

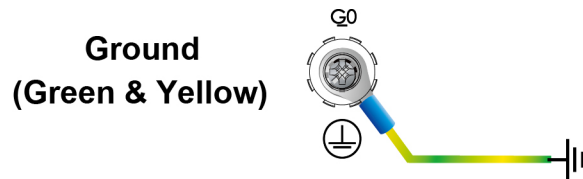

**ATTENTION**

If protective earthing is used as a safeguard, the instructions shall require connection of the equipment protective earthing conductor to the installation protective earthing conductor (for example, by means of a power cord connected to a socket-outlet with earthing connection).

## Power Wiring Methods

The DA-820C comes with single or dual power inputs; both AC and DC power sources are supported. Refer to the following diagrams for detailed wiring methods.

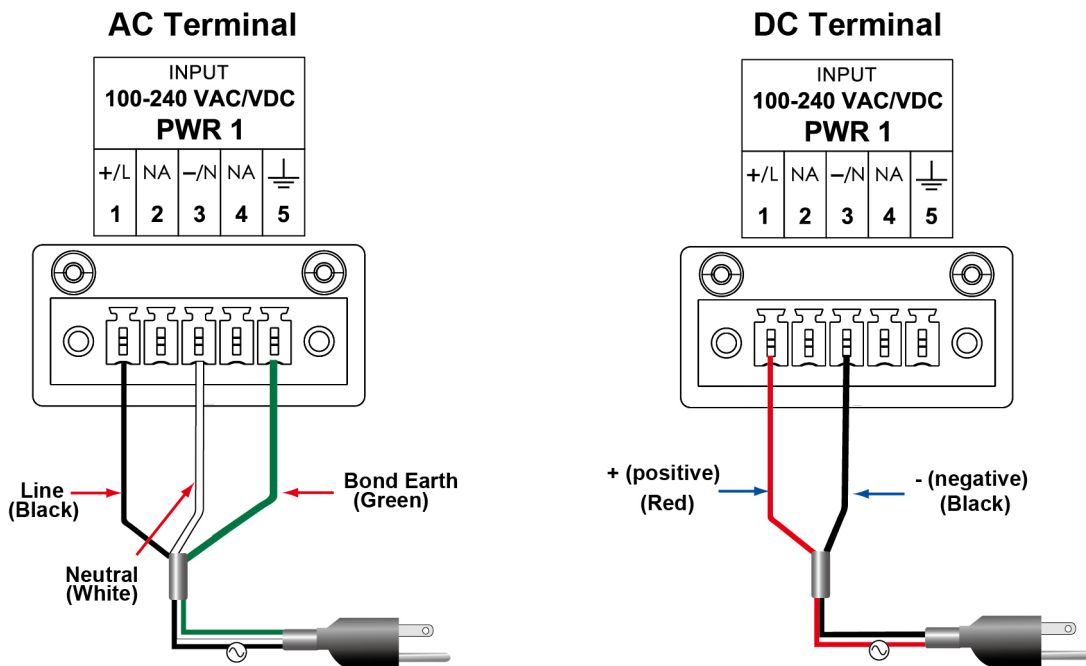



**ATTENTION**

Equipment must be installed according to the applicable country's wiring codes.

In addition, there is a power button switch on the rear panel, which allows users to push to power on the computer again in case the computer is in the sleep or hibernate mode.

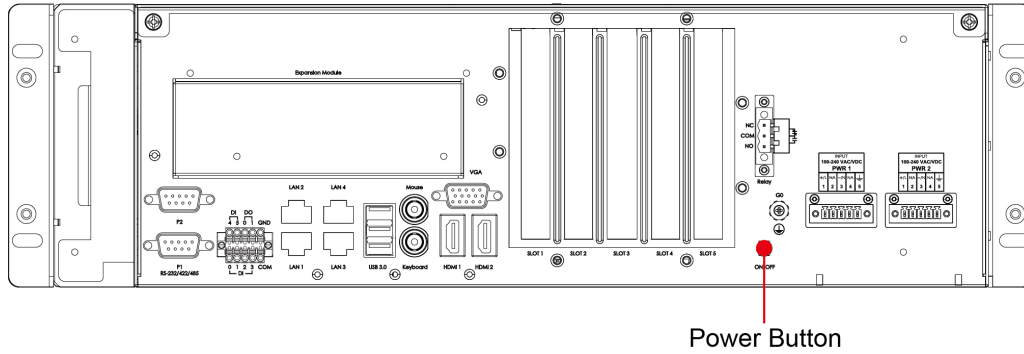

## Reset Button

Pressing the Reset button initiates a hardware warm reboot. The button plays the same role as a desktop PC's reset button. After pressing the reset button, the system will reboot automatically. During normal use, you should NOT use the Reset Button. You should only use this button if the software is not working properly. To protect the integrity of data being transmitted or processed, you should always reset the system from the operating system with the software reboot function.

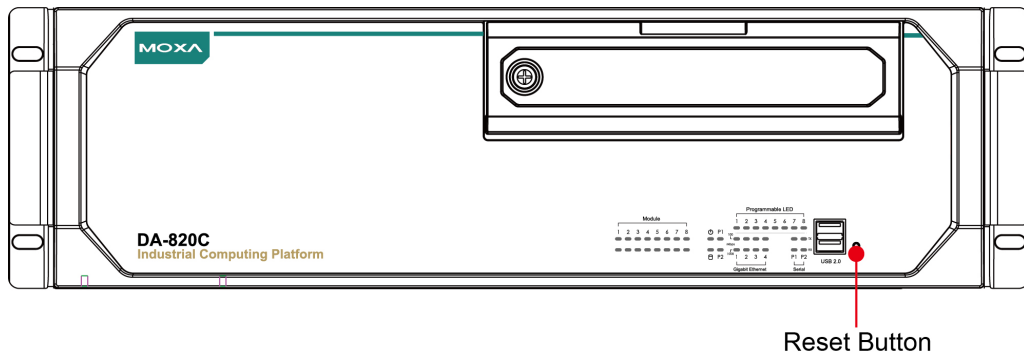



# LED

There are 40 LED indicators on the front panel.

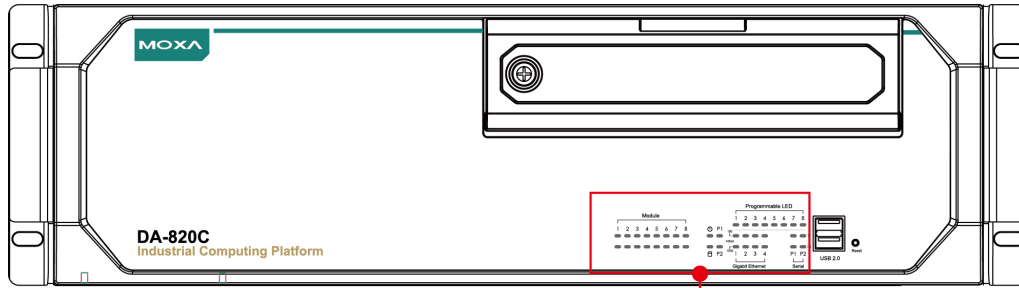

LED Indicators x 40

Information about each LED indicator is given in the following table.

LED	Color	Description
Power	Green	Power is on
	Off	No power input
Storage	Yellow/Blinking	Data is being written to or read from the storage unit
	Off	Storage unit is idle
P1	Off	The 1 <sup>st</sup> power supply is on
	Red	Error in the 1 <sup>st</sup> power supply
P2	Off	The 2 <sup>nd</sup> power supply is on
	Red	Error in the 2 <sup>nd</sup> power supply
Gigabit LAN LEDs 1 to 4	Green	100 Mbps Ethernet mode
	Orange	1000 Mbps (Gigabit) Ethernet mode
Serial Port P1/P2	Green	Tx: Serial data is being transmitted
	Yellow	Rx: Serial data is being received
Programmable LEDs 1 to 8	Green/ Blinking	Can be used to indicate statuses or for debugging, as defined by users.
Module LEDs 1 to 8	Green/Orange/ Blinking	Reserved for LAN-port and serial-port expansion cards.

## Connecting to Displays

The DA-820C comes with 1 VGA interface that uses D-Sub 15-pin female connectors. In addition, 2 HDMI interfaces are also provided on the rear panel.

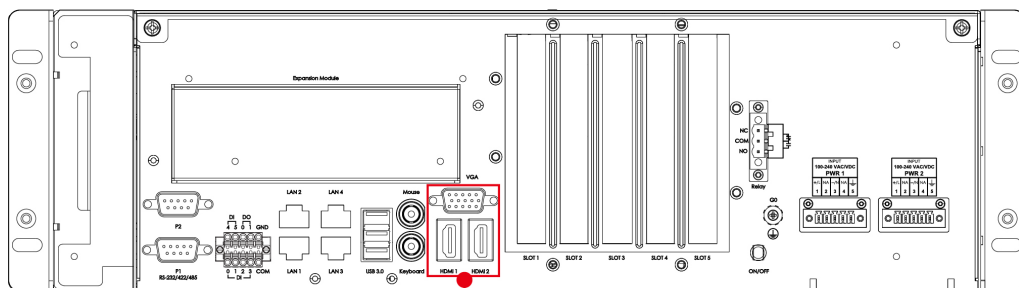

VGA x 1/HDMI x 2

**NOTE** In order to have a highly reliable video streaming capability, choose HDMI-certified HDMI cables.

For the pin definitions of the VGA connector, refer to the following figure and table.

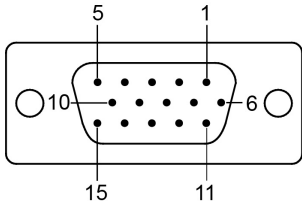

Pin No.	Signal Definition
1	RED
2	GREEN
3	BLUE
4	NC
5	GND
6	GND
7	GND
8	GND
9	VCC
10	GND
11	NC
12	DDC Data
13	HSYNC
14	VSYNC
15	DDC Clock

## Connecting USB Devices

The DA-820C comes with 2 USB 2.0 ports on the front panel and 3 USB 3.0 ports on the rear panel. The USB ports can be used to connect to other peripherals, such as flash drives for expanding the system’s storage capacity. In addition, both USB ports support system boot up, which can be activated by modifying the BIOS settings. See **Chapter 3: BIOS Setup** for details.

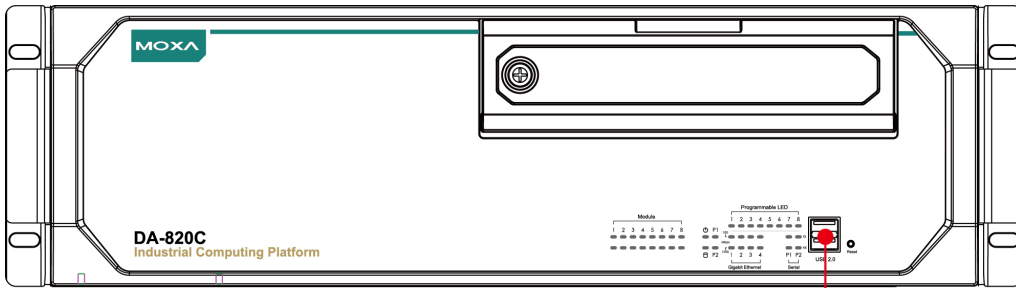

USB Hosts x 2  
(2.0, Type A)

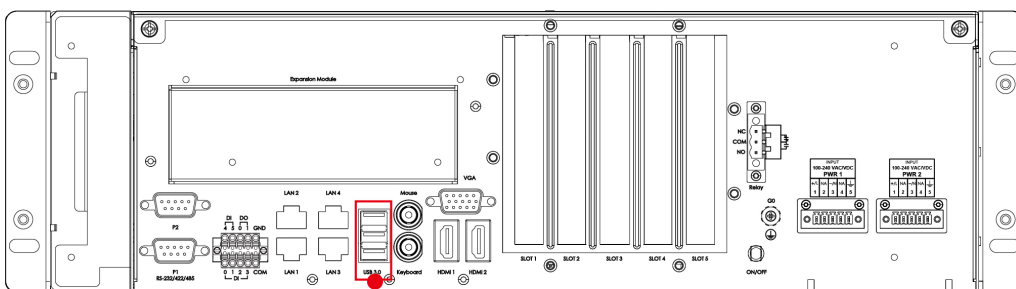

USB Hosts x 3  
(3.0, Type A)

## Installing a USB Dongle Kit

You can use a USB Dongle Kit to secure your USB dongle inside your DA-820C computer.

To install a USB Dongle Kit inside your DA-820C computer, do the following:

**NOTE** The USB Dongle Kit is an optional accessory that can be purchased separately.

1. Power off the DA-820C computer and remove the upper cover of the computer.
2. The USB Dongle Kit includes a USB plate and a screw.

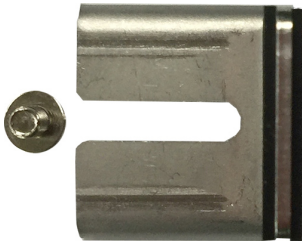

3. Attach the USB device to the USB port inside the DA-820C computer. Place the USB plate on the rail, and push right to the USB device as close as possible. Finally, fasten the screw on the plate.



4. Place the upper cover of the computer.

## Serial Ports

The DA-820C comes with 2 software-selectable RS-232/422/485 serial ports on the rear panel.

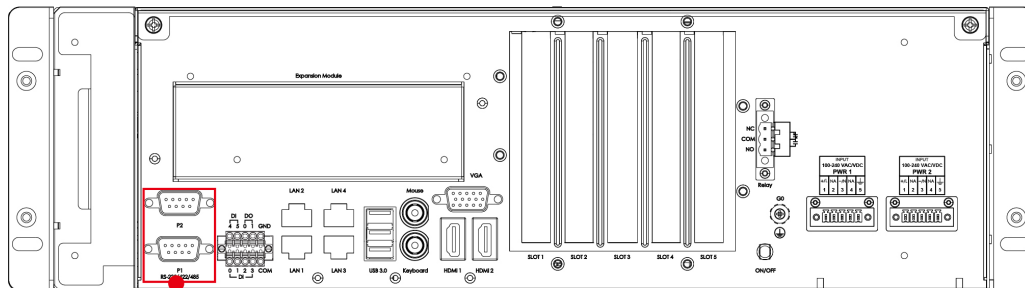

Serial Ports x 2  
(RS-232/422/485, DB9)

The ports use DB9 male connectors. Refer to the following table for the pin assignments:

Pin	RS-232	RS-422	RS-485 (4-wire)	RS-485 (2-wire)
1	DCD	TxDA(-)	TxDA(-)	-
2	RxD	TxDB(+)	TxDB(+)	-
3	TxD	RxDB(+)	RxDB(+)	DataB(+)
4	DTR	RxDA(-)	RxDA(-)	DataA(-)
5	GND	GND	GND	GND
6	DSR	-	-	-
7	RTS	-	-	-
8	CTS	-	-	-

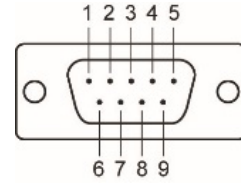

## Gigabit LAN Ports

The DA-820C has 4 Gigabit LAN ports. When a LAN cable is properly connected, the LEDs on the front panel will glow to indicate a proper connection.

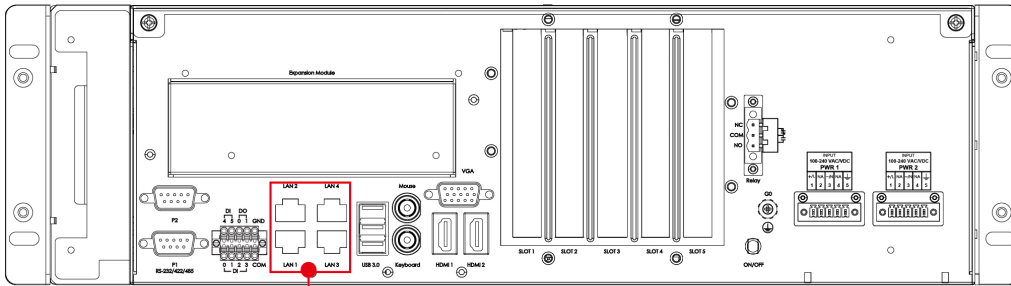

LAN Ports x 4  
(100/1000 Mbps , RJ45)

Refer to the following figure and table for the pin sequence and definitions.

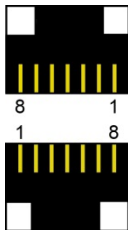

Pin	10/100 Mbps	1000 Mbps
1	Tx+	TRD(0)+
2	Tx-	TRD(0)-
3	Rx+	TRD(1)+
4	-	TRD(2)+
5	-	TRD(2)-
6	Rx-	TRD(1)-
7	-	TRD(3)+
8	-	TRD(3)-

# Digital Inputs/Digital Outputs

The DA-820C comes with six digital inputs and two digital outputs in a terminal block. Refer to the following figure for the location of the DI/DO connectors.

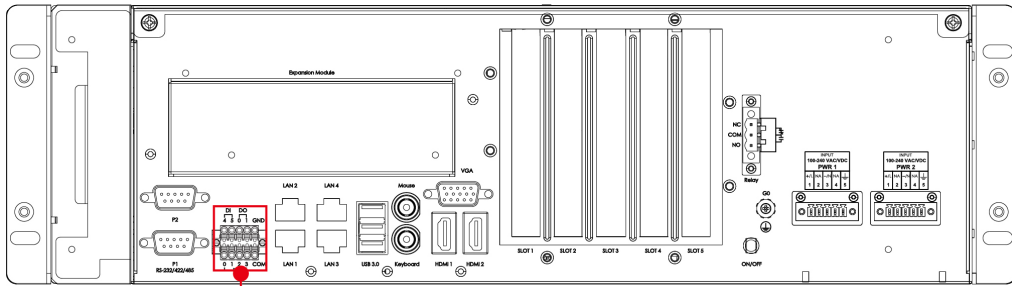

DI x 6/DO x 2  
(Terminal Block)

For pin definitions and wiring methods, see the figures below.

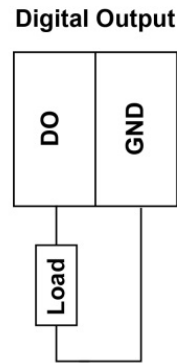
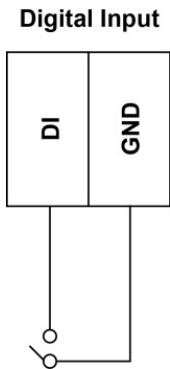
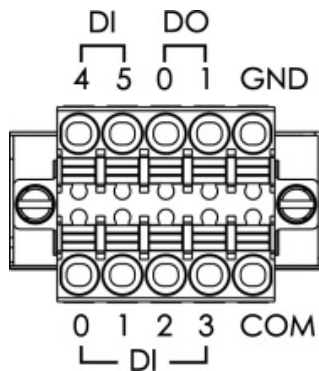

# Relay Output

The DA-820C provides a relay output located on the rear panel of the computer.

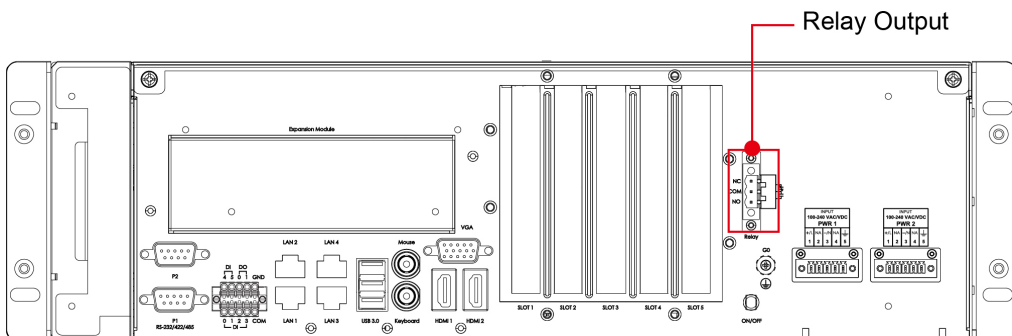

Refer to the figure on the right for detailed pin definition of the relay output connectors.

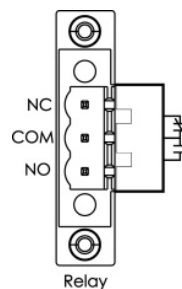

# Upgrading the Memory Module

The DA-820C embedded computer supports 2 ECC registered DDR3 1333/1600 SODIMM modules, for up to 16 GB of memory (2 slots, each with 8 GB). To upgrade the SDRAM memory module, follow these instructions:

1. Disconnect the DA-820C from its power source.
2. Unfasten the screws on the back of the computer, and then take off the upper cover.

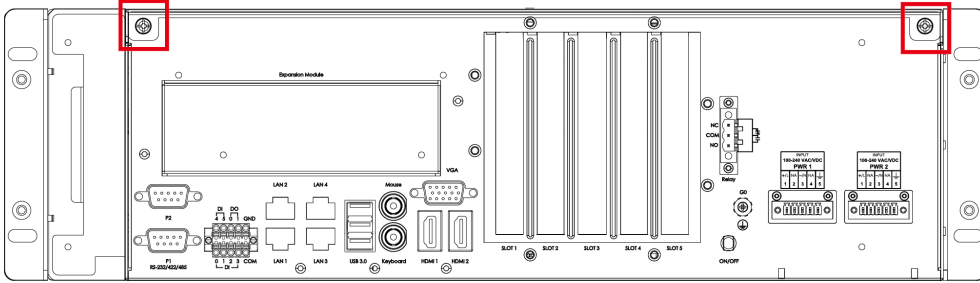

3. Find the location of the SDRAM memory socket.

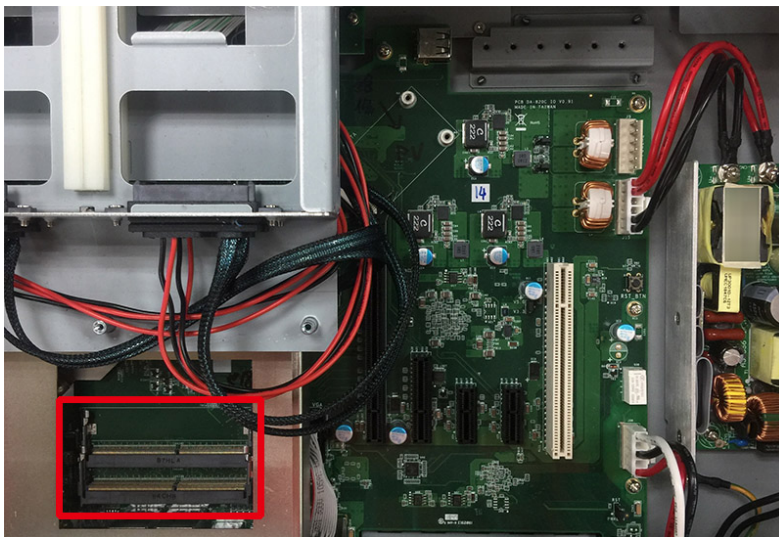

4. If a memory module is already installed in the socket, push the two fasteners to free and then remove the module. Insert the new memory module into the socket, making sure you insert the SDRAM in the correct direction. Push down the memory module, making sure that the two fasteners snap in place and are holding the module firmly.

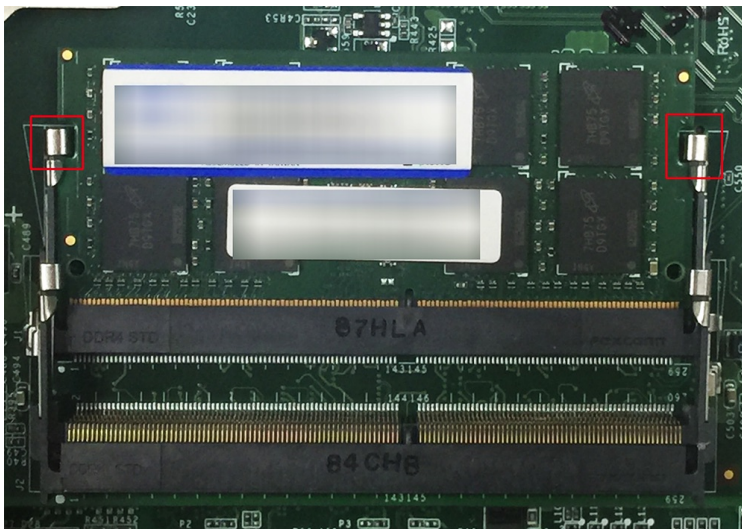

5. When finished, replace the upper cover of the computer and fasten the screws.

# Installing an mSATA Storage Card

The DA-820C embedded computer comes with an mSATA socket. To insert an mSATA storage card, follow these instructions.

1. Disconnect the DA-820C from its power source.
2. Unfasten the screws on the back of the computer, and then take off the upper cover.

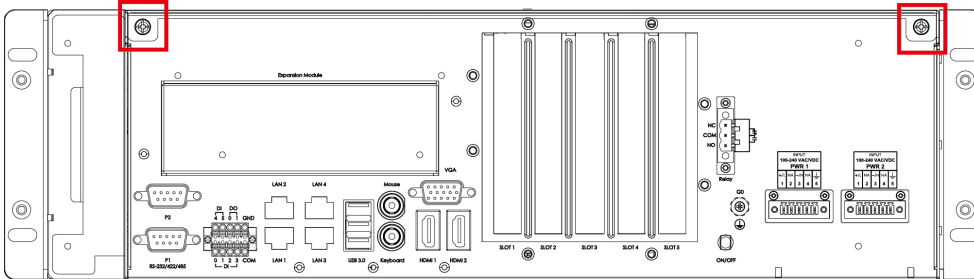

3. Find the location of the mSATA socket.

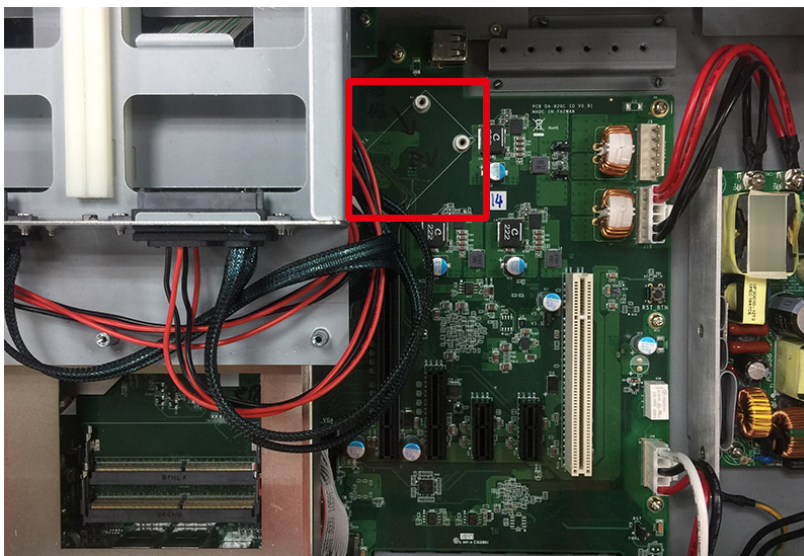

4. Insert the mSATA storage card into the socket, and fasten the two screws to fix the card.

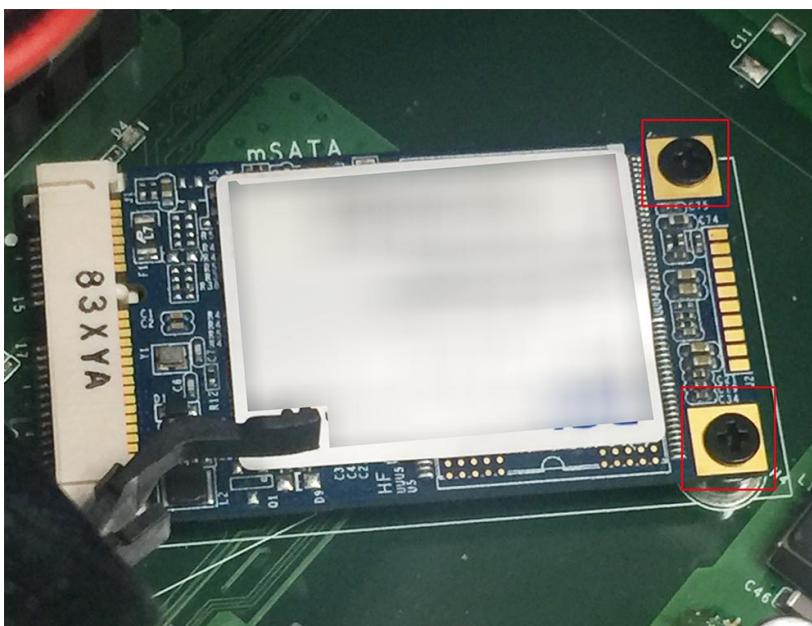

5. When finished, restore the upper cover of the computer and fasten the screws.



**ATTENTION**

The DA-820C rackmount computer does not support the mSATA storage card hot swap and PnP (Plug and Play) functions. It is necessary to remove power source first before inserting or removing the mSATA storage card.

## Installing SATA Hard Disks

The DA-820C comes with four SATA slots that allow users to install four 2.5" SATA HDD/SSD in the computer. Follow these steps to install a SATA disk.

1. Unfasten the screw on the storage disk tray, and pull down the tray door.

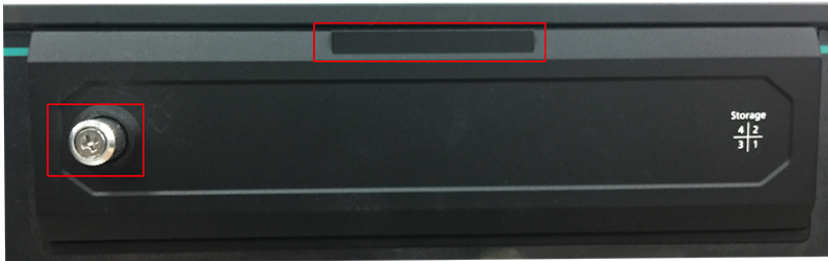

2. There are four disk trays available.



The installation sequence of the disks is indicated in the diagram below. You may install your SATA disk in any slot.

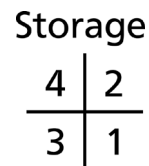

3. Each storage disk tray comes with a clutch. Pull the clutch to the right to take out the tray.

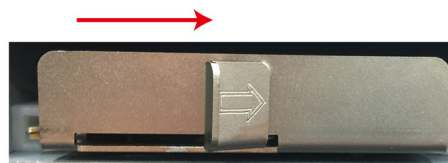



- 4. Place the SATA disk on the tray.

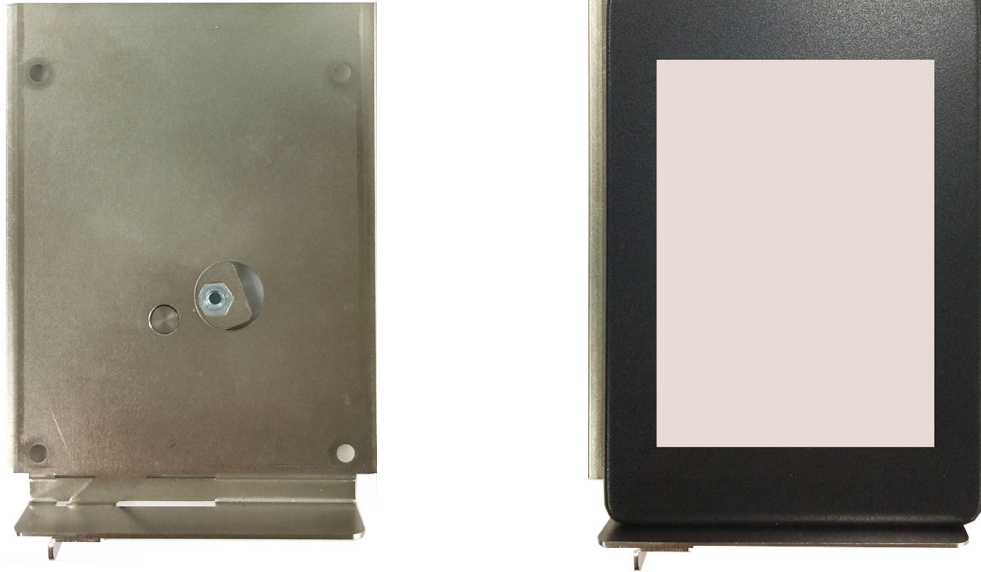

- 5. Turn back to the rear side of the tray, and fasten four screws. See the following diagram for details.

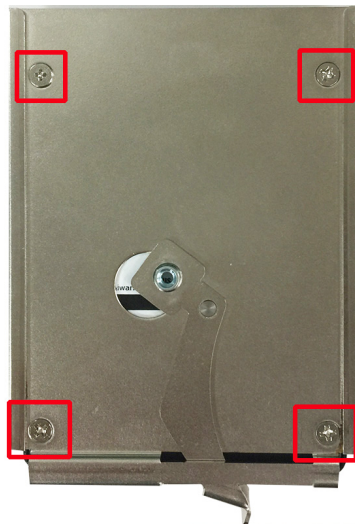

- 6. There are two plastic rails inside the slot. Make sure to insert the storage tray into the rails.

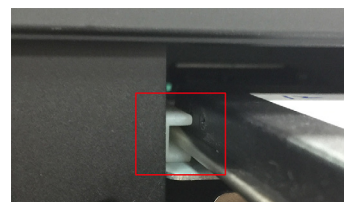
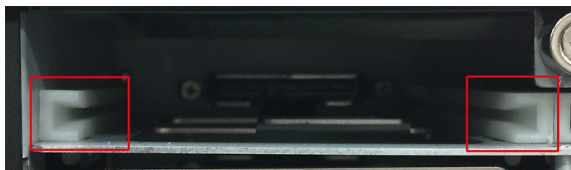

- 7. Push the disk tray into the computer; make sure the storage tray has been successfully inserted. Use the same method to install other three disks if necessary.



- 8. Restore the storage tray door to complete.

# Installing the Expansion Module

The DA-820C comes with an expansion socket, allowing users to install various expansion modules such as Gigabit Ethernet module and serial communication module. Follow these steps.

1. Unfasten the two screws on the module plate, and then remove the plate.

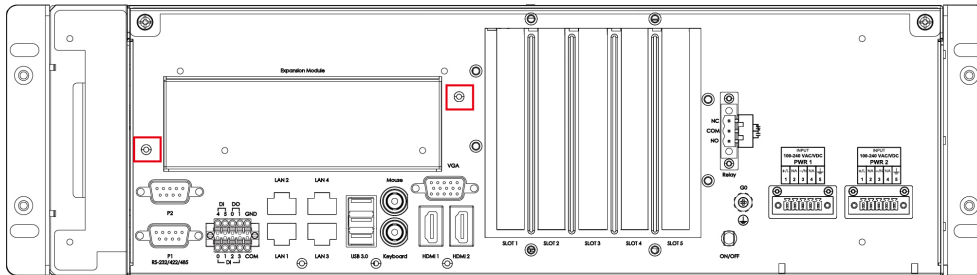

2. Insert the expansion module into the slot.

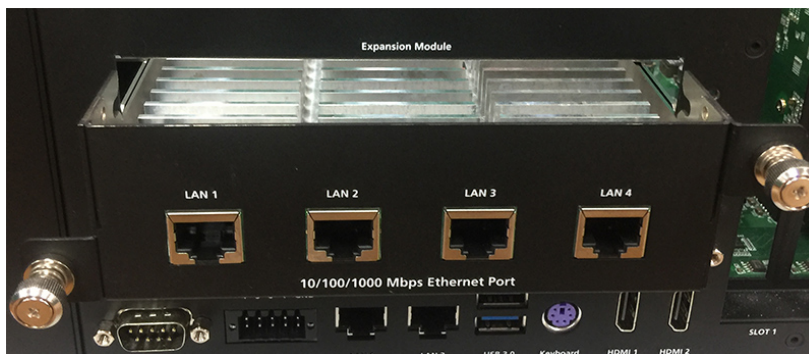

3. Make sure the module has been successfully inserted. Fasten the screws to complete.

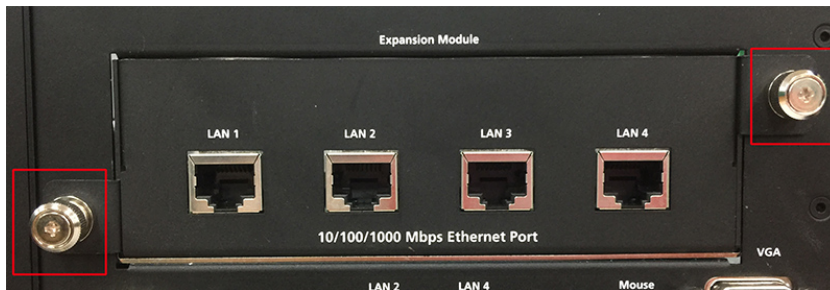

## ATTENTION

Please ensure to power off the computer first and then install/remove the expansion modules.

# Inserting the PCIe/PCI Modules

The DA-820C computer comes with five slots supporting PCIe/PCI interfaces; users can install the modules for various industrial communications. Follow these steps.

1. Unfasten the screws on the rear panel and remove the upper cover.

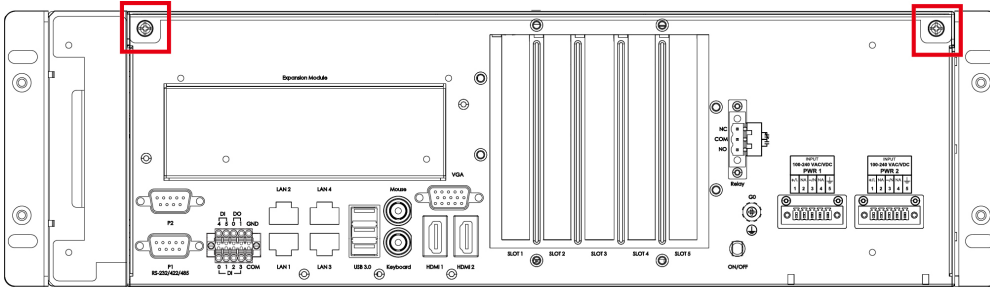

2. Find the location of these slots.

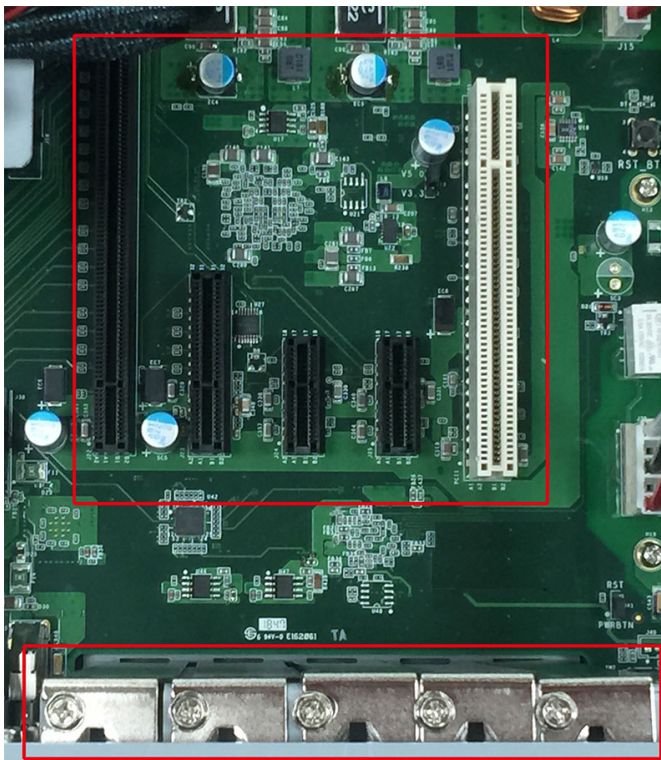

Refer to the following table for the interface details of each slot (from left to right)

Slot 1	Slot 2	Slot 3	Slot 4	Slot 5
PCIe x16 Gen. 3	PCIe x4 Gen. 3	PCIe x1 Gen. 2	PCIe x1 Gen. 2	PCI

3. To insert the module, remove the screw on the protection plate first, and then remove the plate.

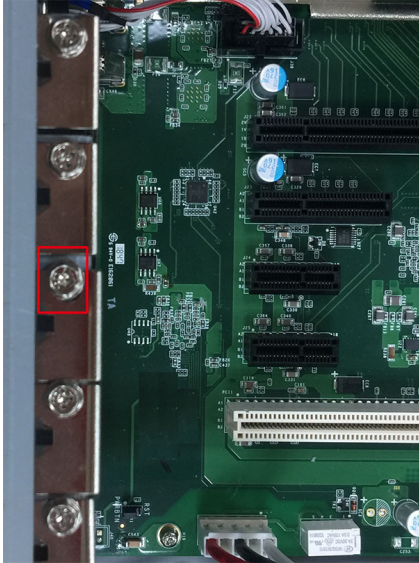

4. Insert the module on the slot carefully. Make sure the module has been successfully inserted.

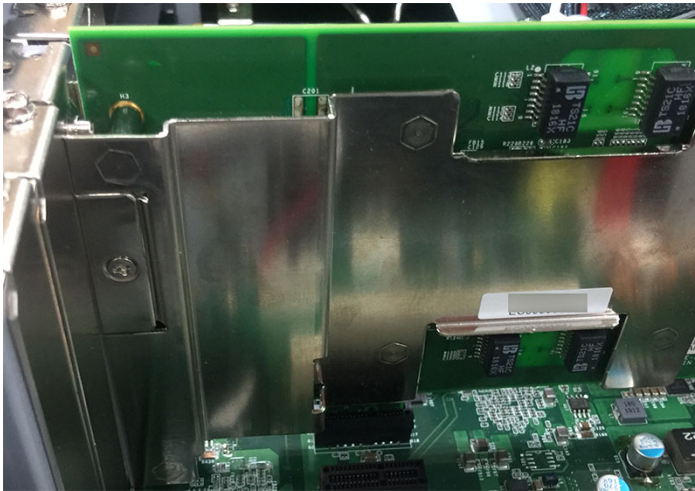

5. Fasten the screw on the module.

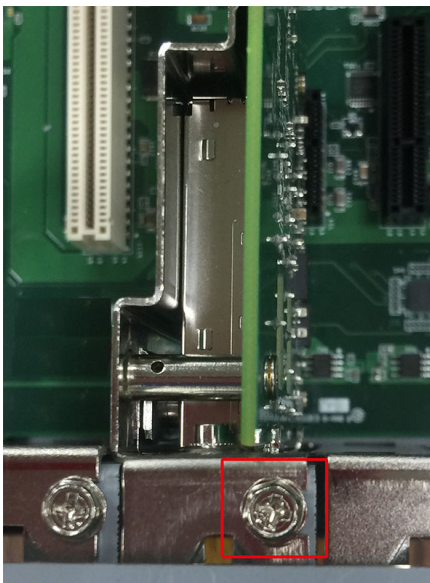

6. Restore the upper cover and fasten the screws to complete.



**ATTENTION**

Please ensure to power off the computer first and then install/remove the PCIe/PCI modules.

## BIOS Setup

---

This chapter describes the BIOS settings of the DA-820C computer. The BIOS is a set of input/output control routines for peripherals, and is used to initialize system peripherals before the operating system is loaded. The BIOS setup allows the user to modify the system configurations of these peripherals' basic input/output.

The following topics are covered in this chapter:

### ❑ Entering the BIOS Setup

#### ❑ Main Page

#### ❑ Advanced Settings

- Boot Configuration
- SATA Configuration
- Intel Rapid Storage Technology
- CPU Configuration
- Active Management Technology Support
- Video Configuration
- Chipset Configuration
- SIO ITE8786E
- Console Redirection

#### ❑ Security Settings

- Current TPM Device
- TPM State
- Clear TPM
- Set Supervisor Password

#### ❑ Power Settings

- Wake on LAN
- Auto Wake on S5
- Power On USB3 (Rear)
- Power On USB2 (Front)
- Power On USB2 (Internal)
- PS/2 Keyboard Power-Up

#### ❑ Boot Settings

- Boot Type
- Network Stack
- PXE Boot capability
- Timeout
- EFI

### ❑ Exit Settings

- Exit Saving Changes
- Save Change Without Exit
- Exit Discarding Changes
- Load Optimal Defaults
- Load Custom Defaults
- Save Custom Defaults
- Discard Changes

#### ❑ Enable AMT

#### ❑ Use AMT

#### ❑ Upgrading the BIOS

# Entering the BIOS Setup

To enter the BIOS setup utility, press the "F2" key while the system is booting up. The main **BIOS Setup** screen will appear. Five options will be available:

- **Continue:** Continue to boot up
- **Boot Manager:** Select the device for booting up
- **Device Manager:** Enter the device configuration menu
- **Boot From File:** Select the UEFI boot up file
- **Setup Utility:** Enter the BIOS configuration menu
- **Intel® Management Engine BIOS Extension:** Enter the AMT configuration menu

Select **F2** to enter the **BIOS configuration**.

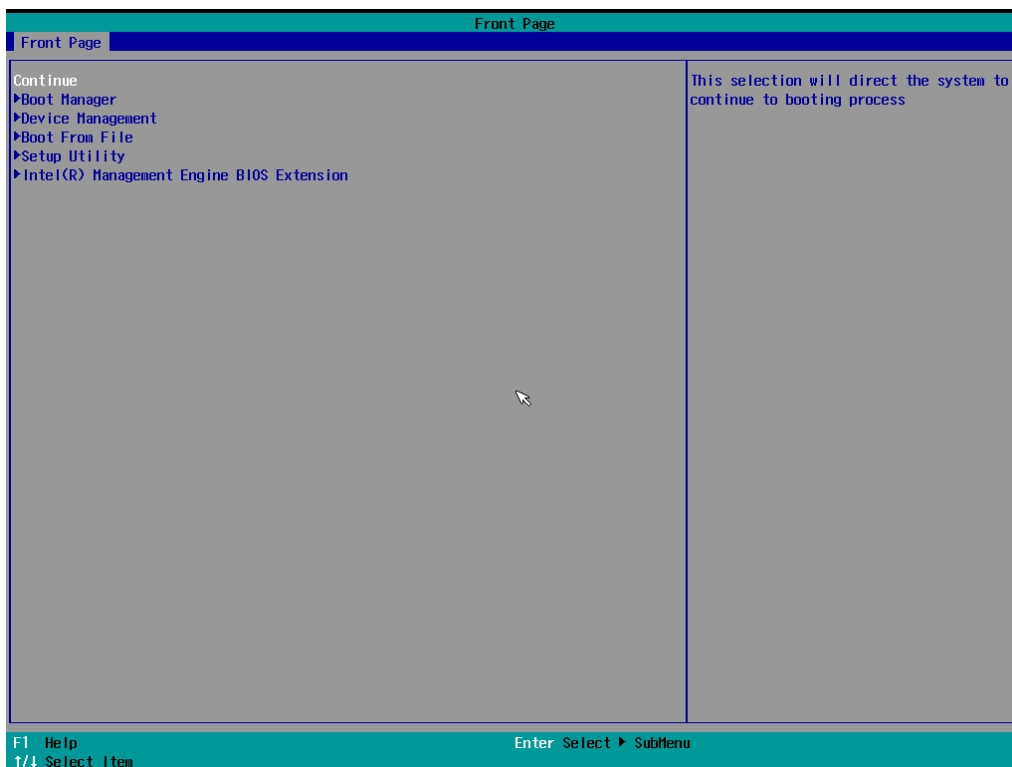

When you enter **Setup Utility**, a basic description of each function key is listed at the bottom of the screen. Refer to these descriptions to learn how to use them.

<b>F1</b>	<b>General Help</b>	↑ ↓ .	<b>Select Item</b>
<b>F5/ F6</b>	<b>Change Values</b>	← →	<b>Select Menu</b>
<b>F9</b>	<b>Setup Defaults</b>	<b>ESC</b>	<b>Exit</b>
<b>F10</b>	<b>Save and Exit</b>	<b>EN TER</b>	<b>Select or go to Submenu.</b>

The BIOS configuration screen will be shown when you enter the **Setup Utility** option, as shown in the following figure.

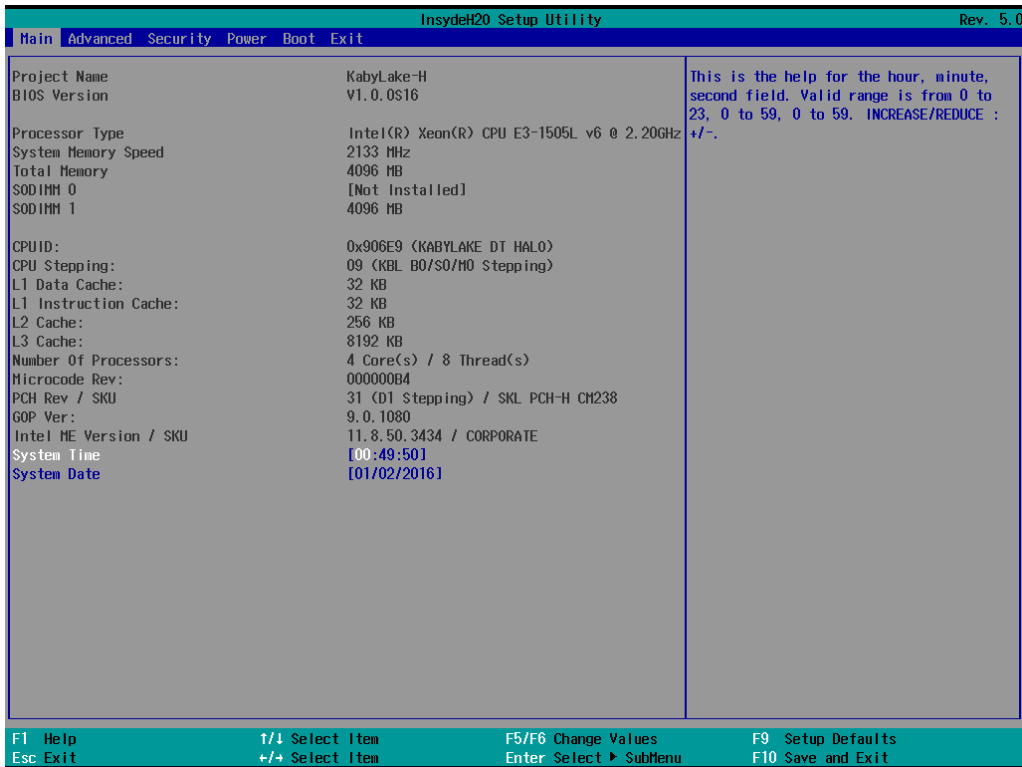

Note that the **Processor Type** information for will vary depending on which model you purchased.



# Main Page

The **Main** page displays basic system hardware information, such as model name, BIOS version, and CPU type.

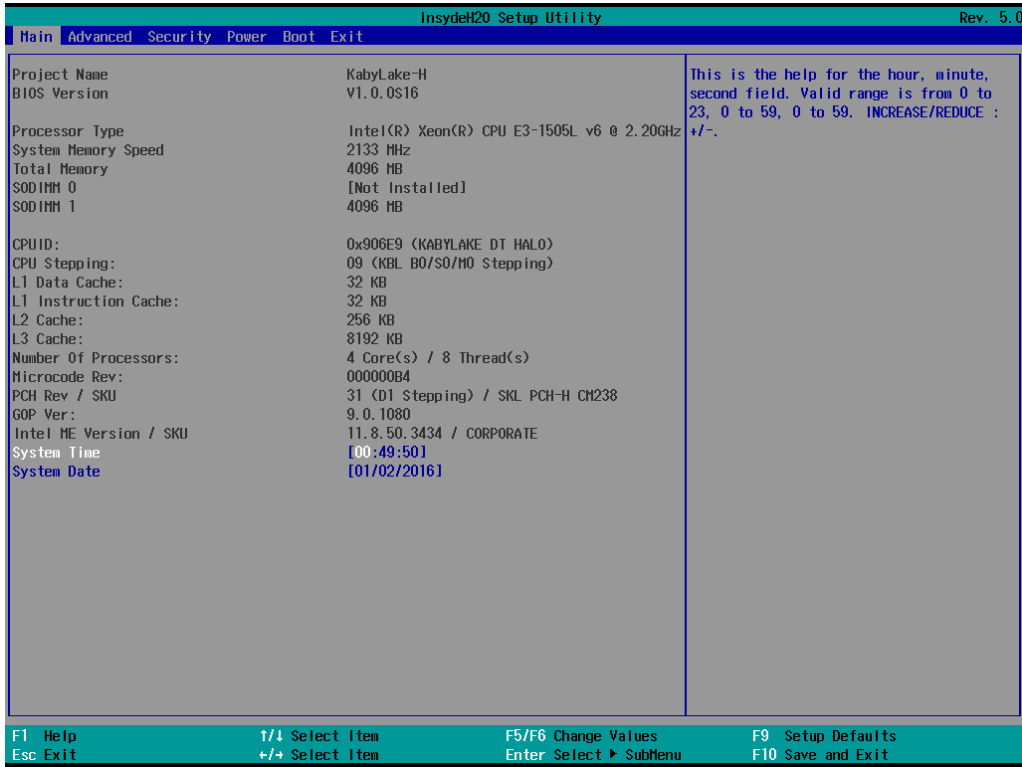

# Advanced Settings

Select the "Advanced" option in the main menu to open the "Advanced Features" screen.

**NOTE** The Active Management Technology is not supported in the KL3 models.

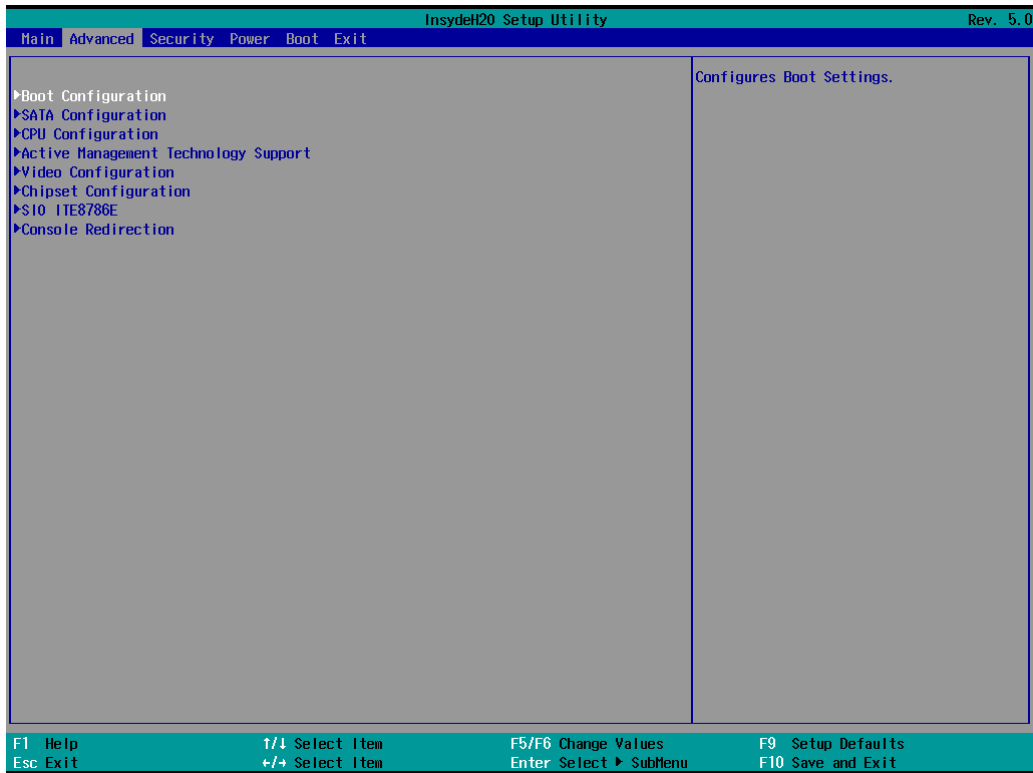

## Boot Configuration

This item allows users to configure the default value of Numlock.

Options: On (default), Off.

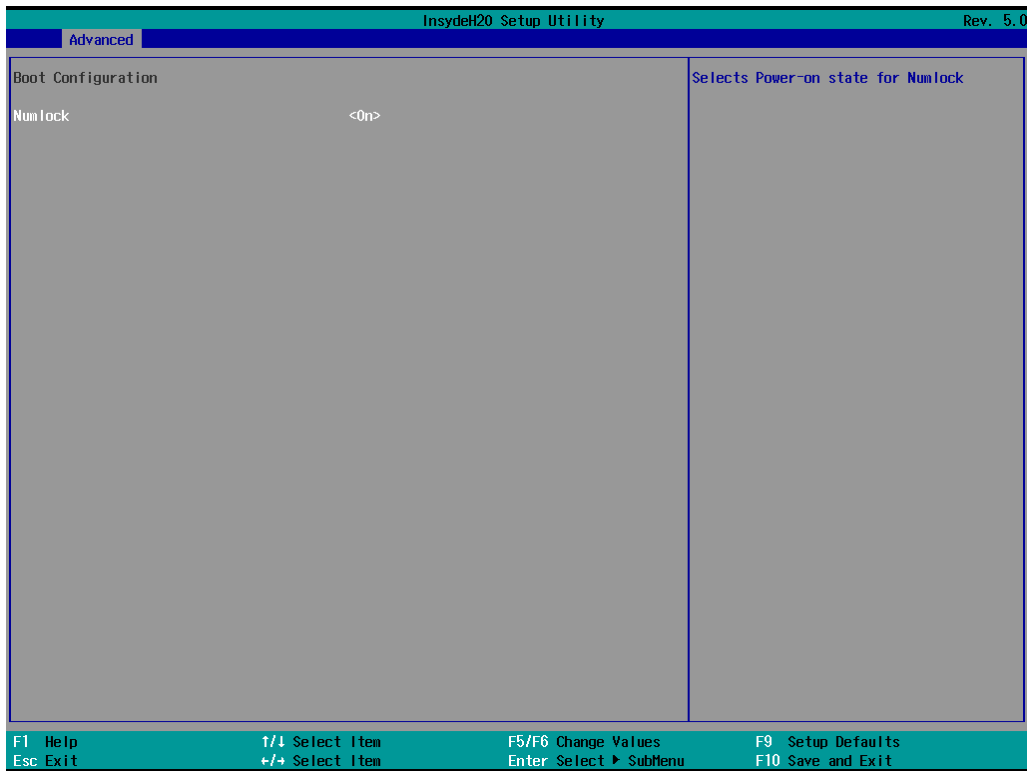

## SATA Configuration

The host drive controller can be configured for AHCI (default) or Intel RST Premium mode.

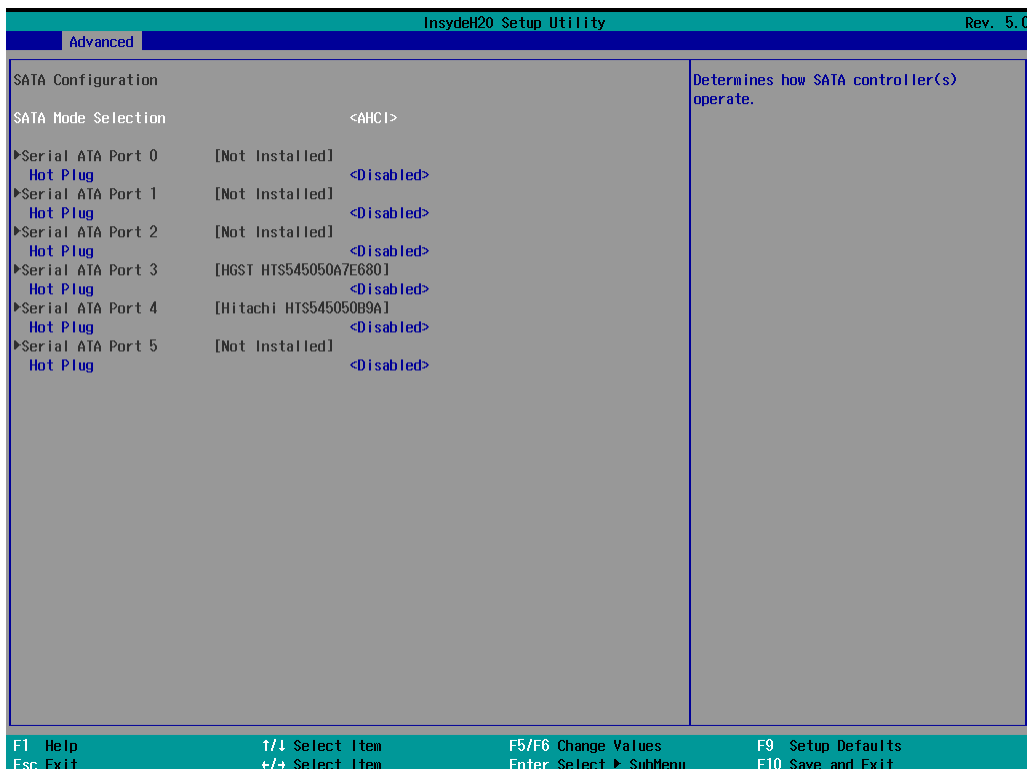

## Serial ATA Port

This setting allows the user to display information about the installed drives.

## SATA Port—HotPlug

This item allows you to enable/disable hot-plugging capabilities (the ability to remove the drive while the computer is running) for installed storage drives.

Options: Disabled (default), Enabled

## RAID

Set HDC configuration as "Intel RST Premium" to enable **redundant array of inexpensive disks** technology. The DA-820 supports RAID levels 0, 1, 5, 10, and Recovery.

**Recovery** utilizes RAID 1 (mirroring) functionality to copy data from a designated master drive to a designated recovery drive. The master drive data can be copied to the recovery drive either continuously or on request.

When using the continuous update policy, changes made to the data on the master drive while the system is not docked are automatically copied to the recovery drive when the system is re-docked. When using the on request update policy, the master drive data can be restored to a previous state by copying the data on the recovery drive back to the master drive.

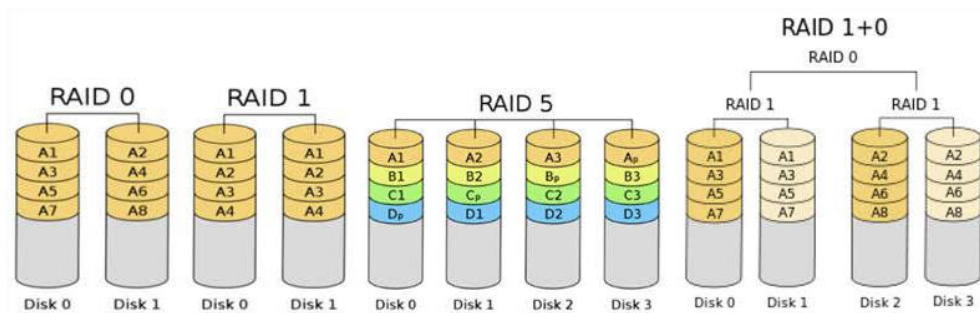

These figures were obtained from Wikipedia. Please refer to [http://en.wikipedia.org/wiki/Standard\\_RAID\\_levels](http://en.wikipedia.org/wiki/Standard_RAID_levels) for details.

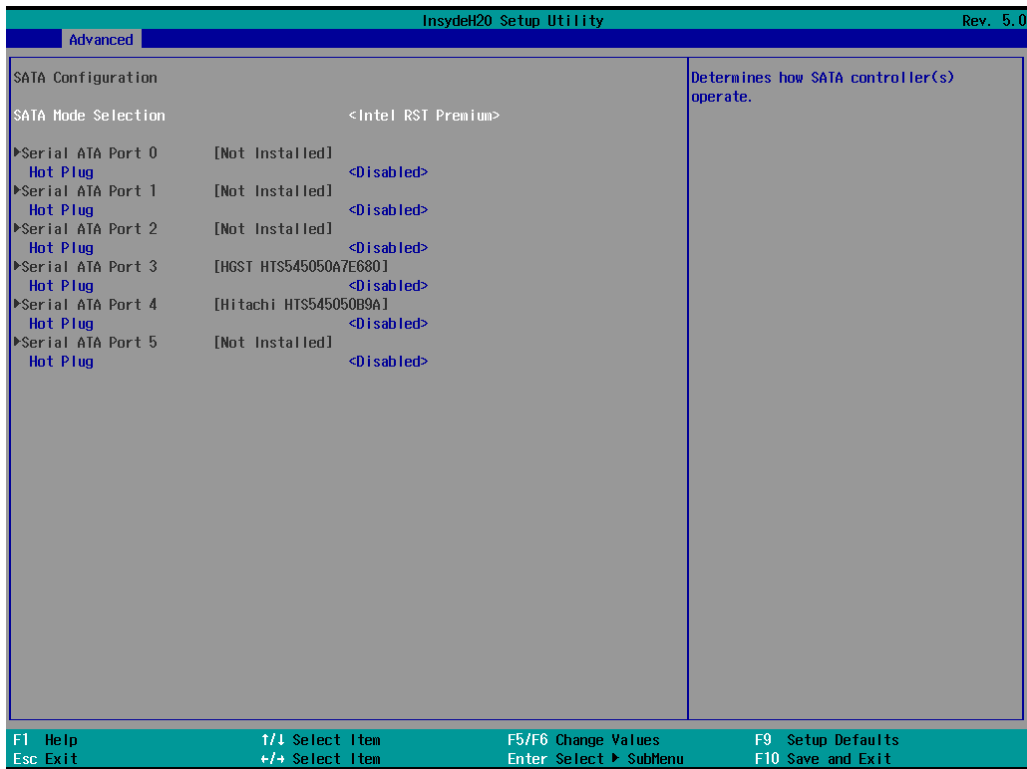

From **Device Management** to configure the following **Intel Rapid Storage Technology**.

## Intel Rapid Storage Technology

This section allows users to configure Intel® Rapid Storage Technology.



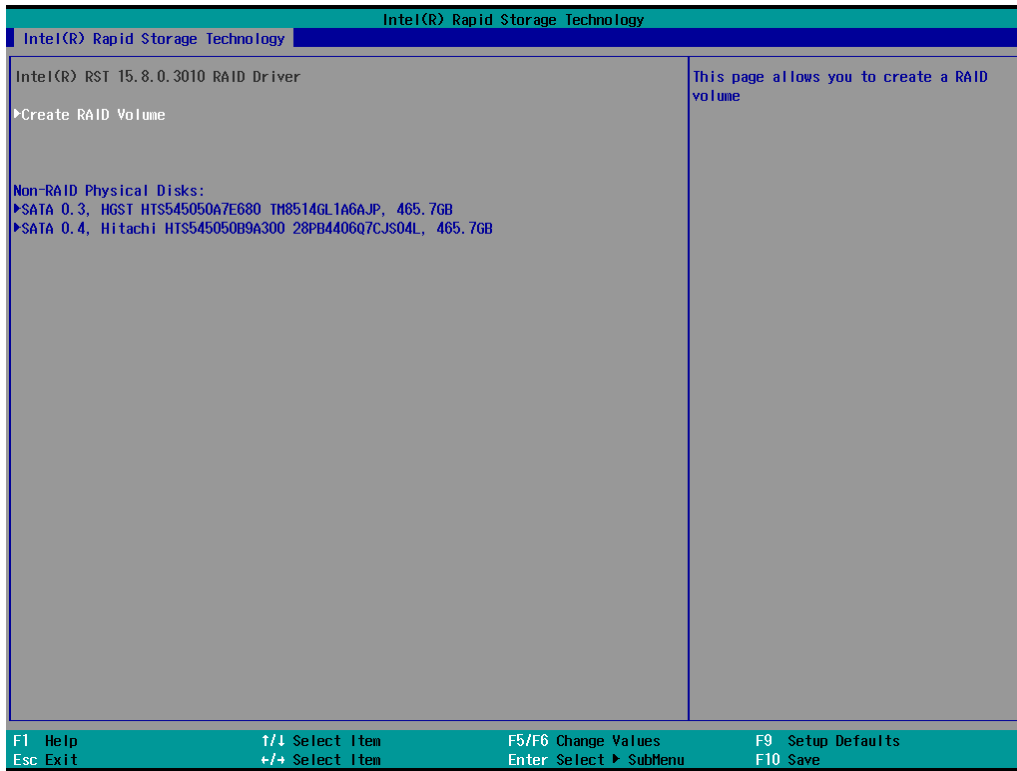

## CPU Configuration

**NOTE** Hyper-Threading is not supported in the KL5 models.

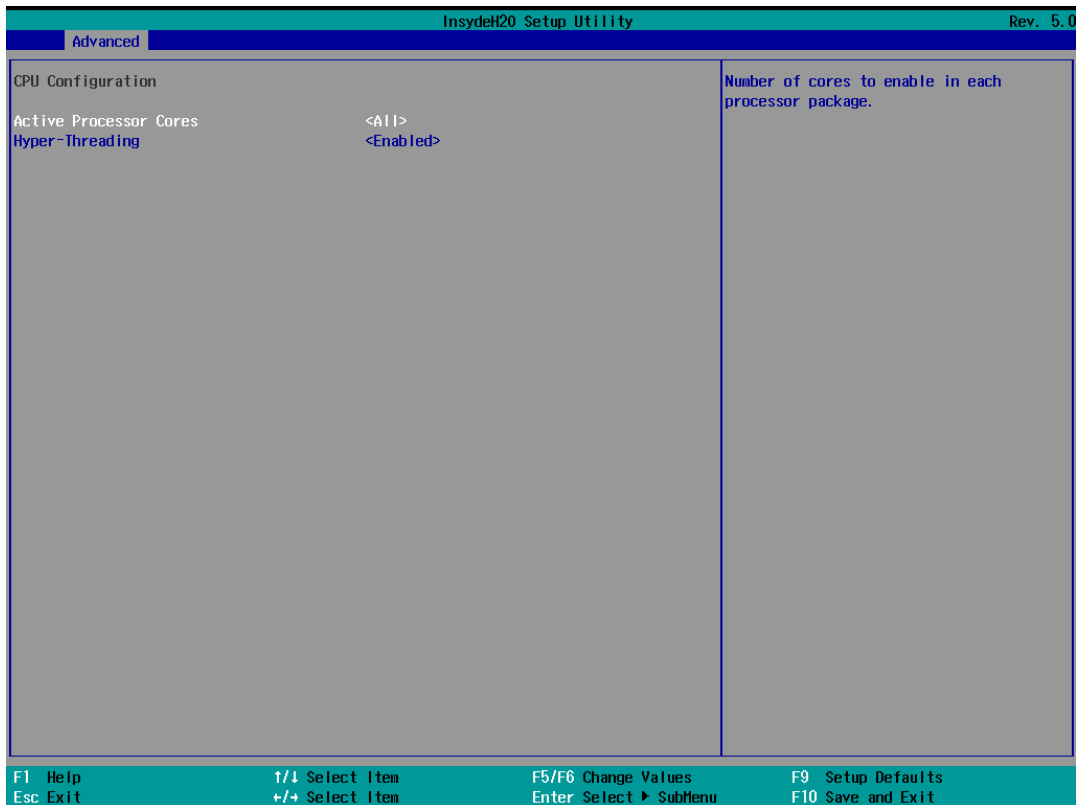

## Active Processor Cores

This item indicates the number of cores to enable in each processor package.

## Hyper-Threading

This feature makes the processor resources work more efficiently, enabling multiple threads to run on each core. It also increases processor throughput, improving overall performance on threaded software.

Options: Disabled, Enabled (default)

## Active Management Technology Support

This item allows you to configure the Intel® Active Management Technology (KL3 model does not support this function).

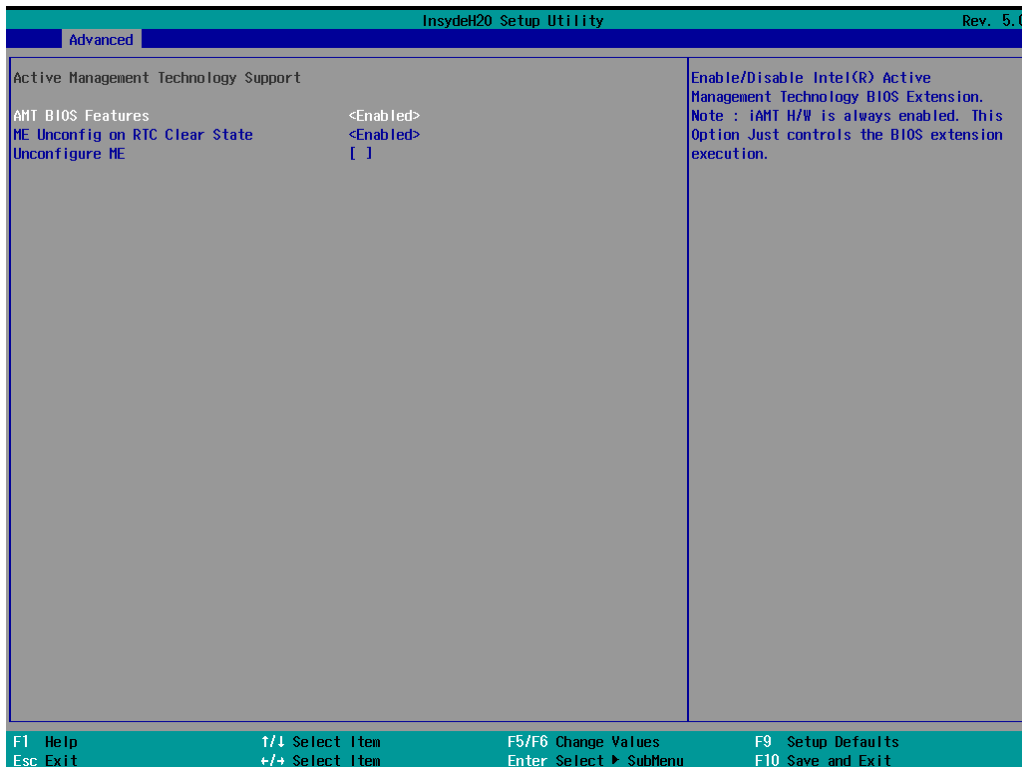

## AMT BIOS Features

This item allows users to enable/disable Intel® Active Management Technology BIOS Extension.

Note: iAMT H/W is enabled by default. This option just controls the BIOS extension execution.

Options: Disabled, Enabled (default)

## ME Unconfig on RTC Clear State

Disabling this option will cause ME not to unconfigure on RTC clear.

Options: Disabled, Enabled (default)

## Unconfigure ME

Unconfigure ME with resetting MEBx password to default.

## Video Configuration

This item allows you to configure the built-in Internal Graphics Device or external PCI Express Graphics card.

Options: IGFX (default), PEG

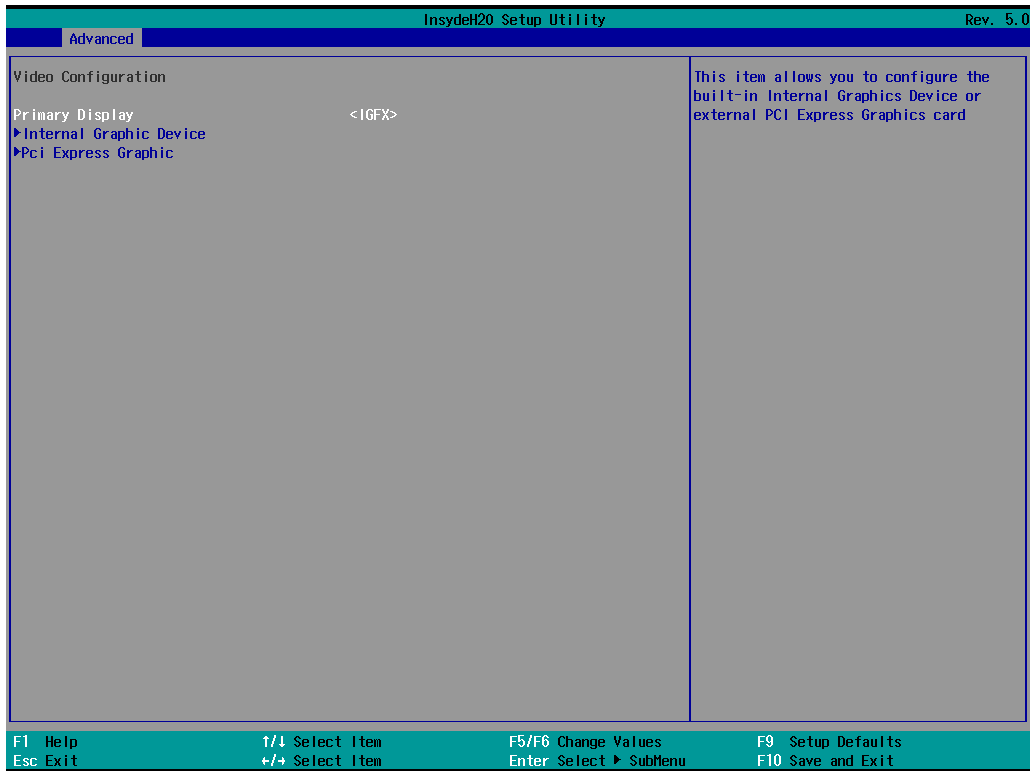



## Internal Graphics Device

This option allows you to enable/disable the internal graphics device.

Options: Enabled (default), Disabled

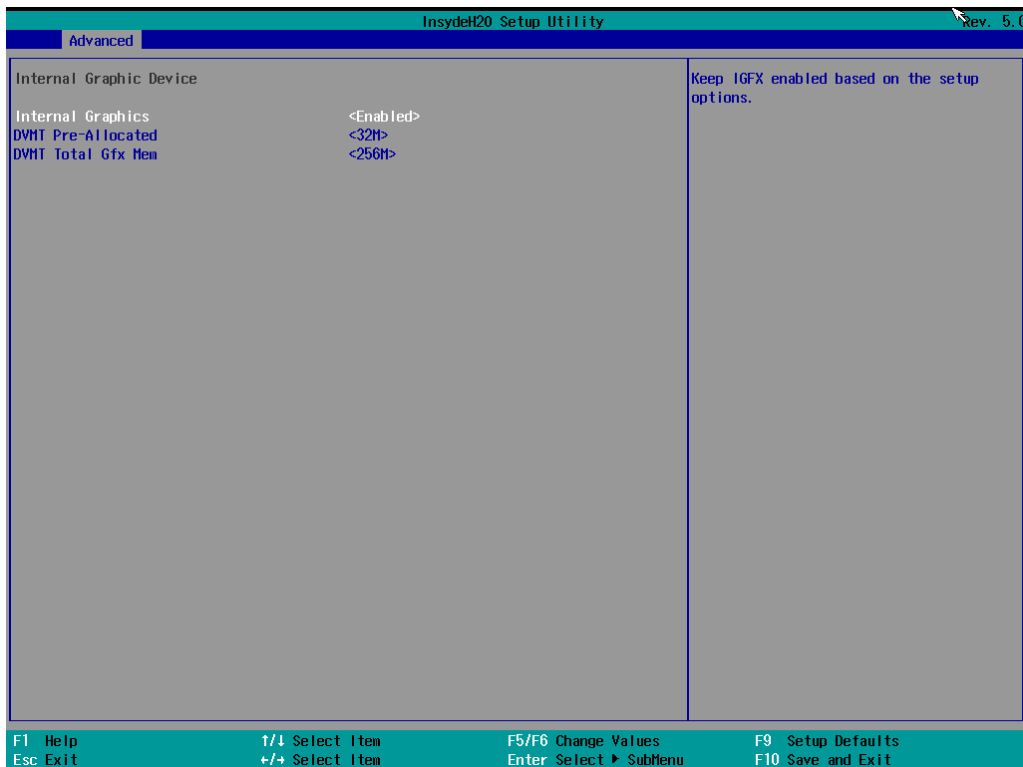

## IGD—DVMT Pre-Allocated

This item allows you to configure pre-allocated memory capacity for the IGD. Pre-allocated graphics memory is invisible to the operating system.

Options: 12 M, 16M, 20M, 24M, 28M, 32M (default), 36M, 40M, 44M, 48M, 52M, 56M, 60M, 64M

**DVMT** is a BIOS solution where “the optimum amount of memory is dynamically allocated and de-allocated as needed for balanced graphics and system performance, through Intel® Direct AGP and a highly efficient memory utilization scheme.” DVMT ensures the most efficient use of available system memory resources for maximum 2D/3D graphics performance.

## IGD—DVMT Size

This item allows you to configure the maximum amount of memory DVMT will use when allocating additional memory for the internal graphics device.

Options: 256 MB (default), 128 MB, Max.

## PCI Express Graphic

This option allows you to configure the external PCI Express Graphics card.

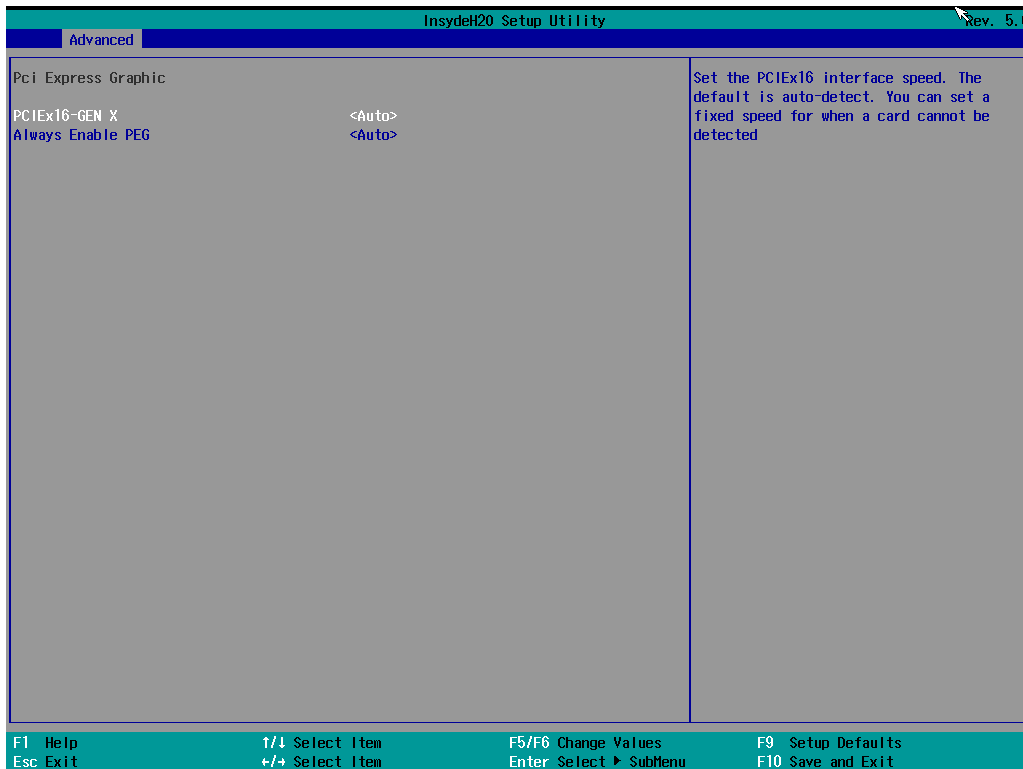

### PCIEx16-GEN X

Set the PCIEx16 interface speed. The default is auto-detect. You can set a fixed speed for when a card cannot be detected.

Options: Auto (default), Gen1, Gen2, Gen3

### Always Enable PEG

When the system doesn't detect a PCIEx16 card, it will disable the PCIE x16 interface to free up resources. Enabling this setting will ensure that the interface is always enabled.

Options: Disabled, Enabled, Auto (default)

## Chipset Configuration

This item allows you to configure the chipset settings.

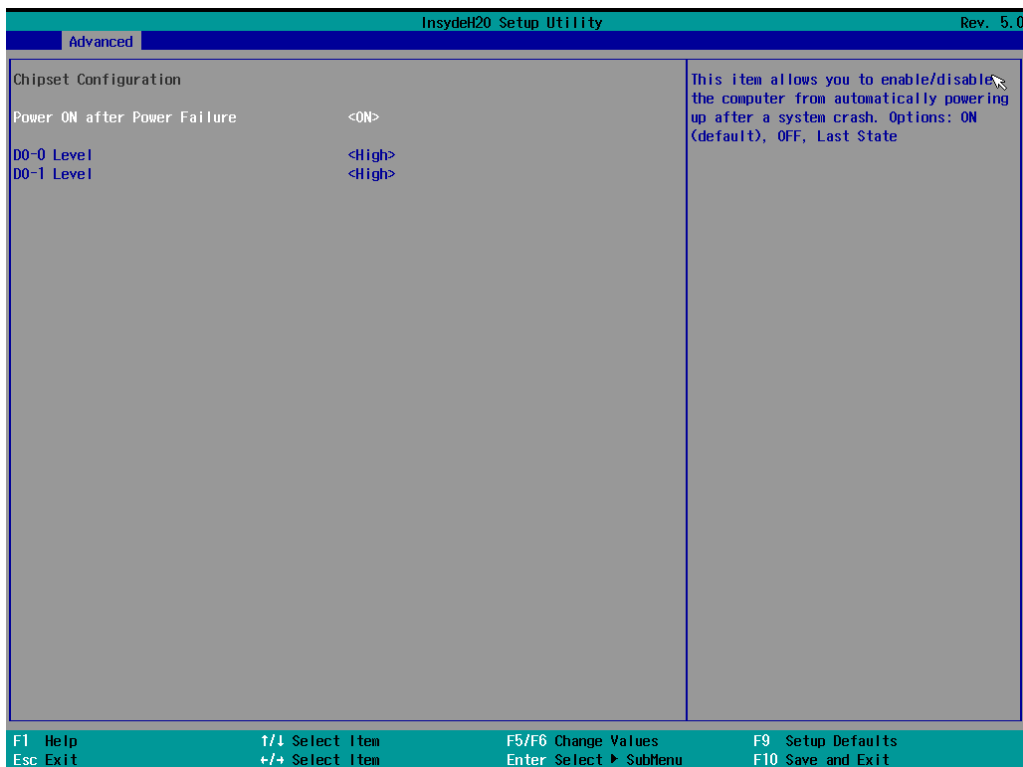

### Power ON after Power Failure

This item allows you to enable/disable the computer from automatically powering up after a system crash.

Options: ON (default), OFF, Last State

### DO-0 Level

This item allows users to set the DO 0 as high or low.

Options: High (default), Low

### DO-1 Level

This item allows users to set the DO 1 as high or low.

Options: High (default), Low

## SIO ITE8786E

This section allows users to configure serial port settings.

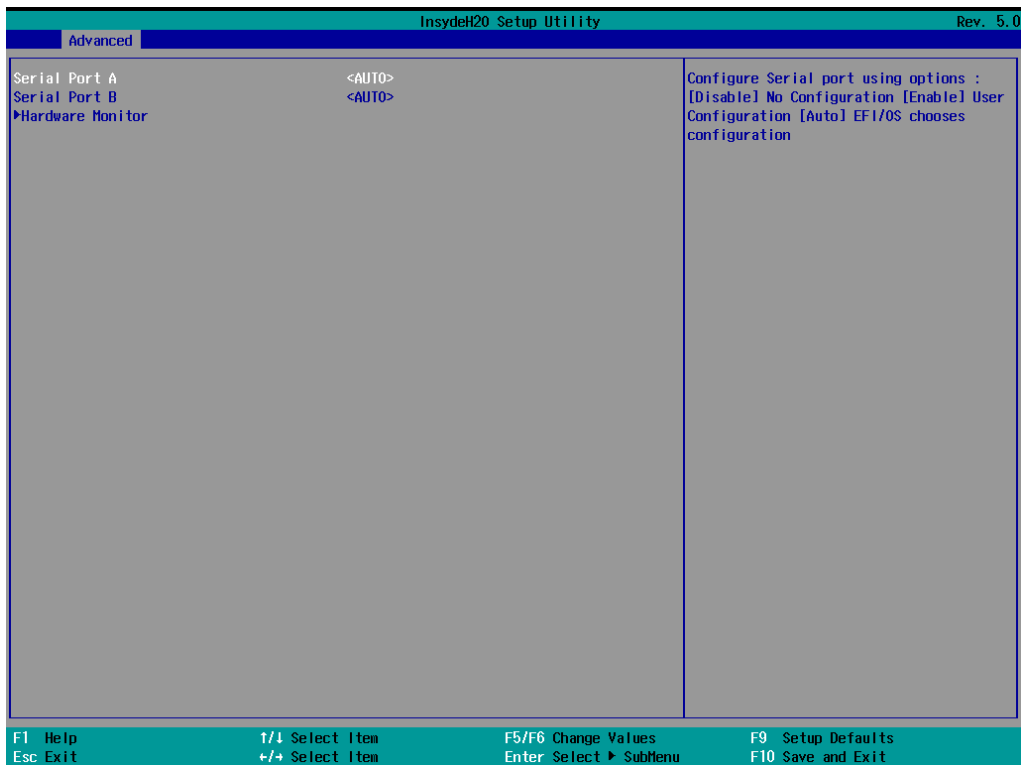

### Serial Port A

This function allows users to configure the resources for serial port A.

Disable: No resources

Enable: User configures the resources

Auto (default): EFI/OS chooses the resources

### Serial Port B

This function allows users to configure the resources for serial port B.

Disable: No resources

Enable: User configures the resources

Auto (default): EFI/OS chooses the resources

## Hardware Monitor

This item allows you to view stats such as CPU and system temperature, voltage levels, and other chipset information.

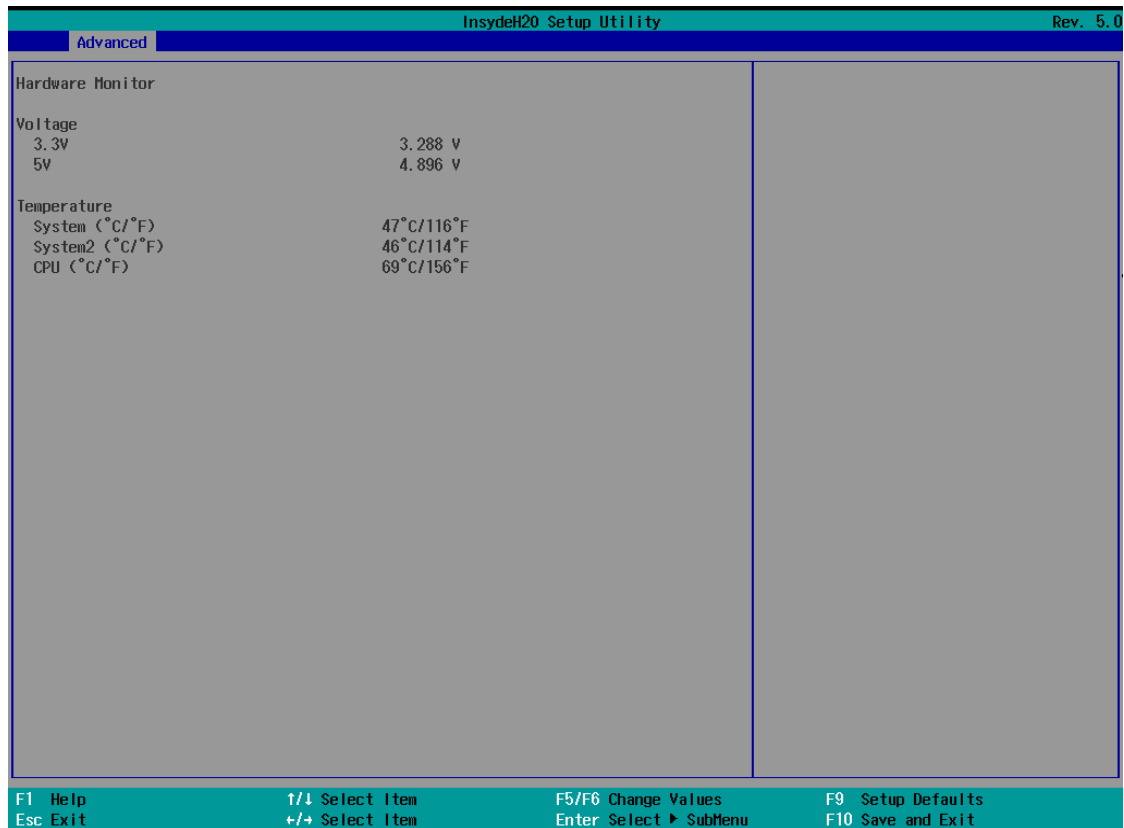

The voltage values will vary depending on which model you purchased. There is a 5% tolerance for temperature values. Note that at 100°C the accuracy of CPU temperature readings are in the range of -5°C to +10°C. This deteriorates to -10°C to +15°C at 50°C. The CPU temperature readings are saturated at some point below 50°C. Any CPU reading below 50°C is unreliable, and may only be interpreted as indicating a temperature below 50°C. For system temperature, there is a 5% tolerance for the temperature values.

## Console Redirection

When the Console Redirection Function is enabled, the console information will be output to both the HDMI monitor and through the serial port.

Options: Disabled (default), Enabled

# Security Settings

This section allows users to configure security-related settings with a supervisor password and user password.

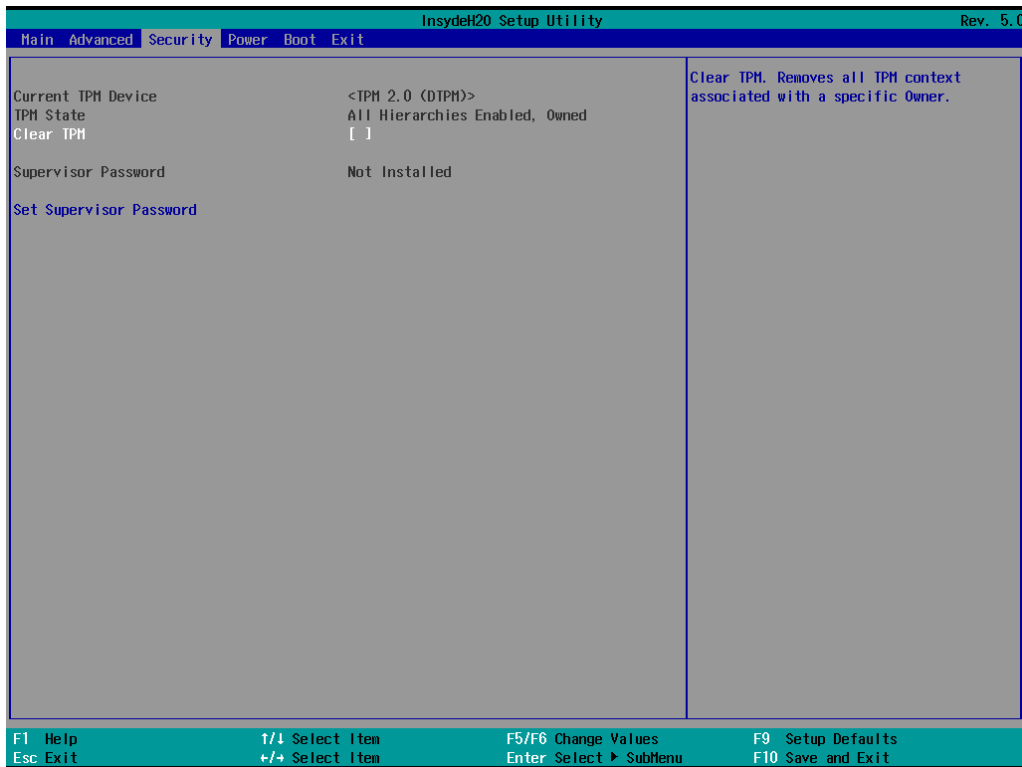

## Current TPM Device

This item shows if the system has TPM device and its type.

## TPM State

This item allows you view the status of current TPM settings.

## Clear TPM

This item allows users to remove all TPM context associated with a specific owner.

Options: Disabled (default), Enabled

## Set Supervisor Password

This item allows you to set the supervisor password. Select the **Set Supervisor Password** option and enter the password and confirm the password again.

To delete the password, select the **Set Supervisor Password** option and enter the old password; leave the new password fields blank, and then press enter.

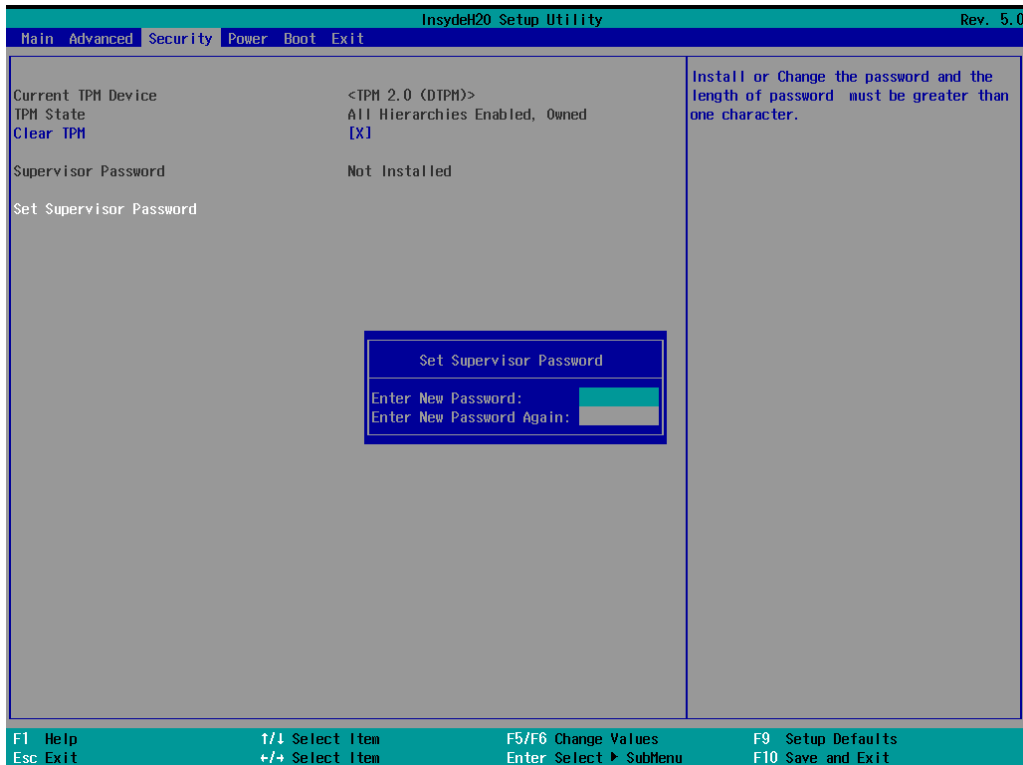

After setting the supervisor password, users can choose when asking input password screen will pop up.

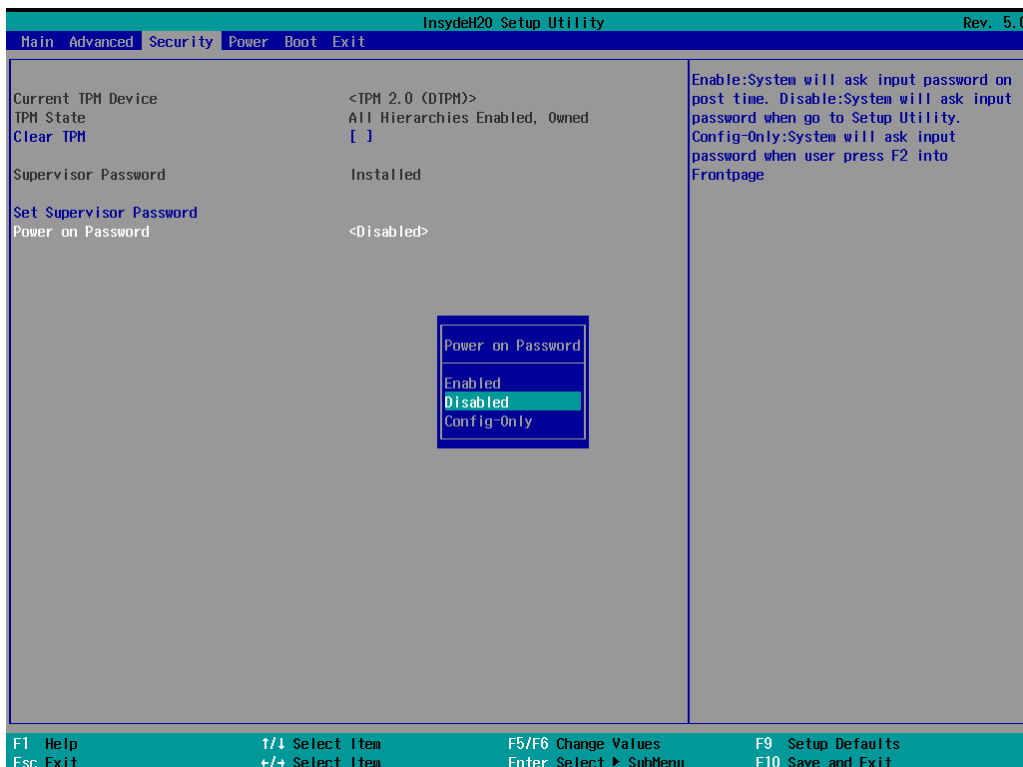

*Enable:* System will ask input password on post time.

*Disable:* System will ask for the password to go to the setup utility.

*Config-Only:* System will only ask for the password when you select the config (F2) option

## Power Settings

The section allows users to configure power settings.

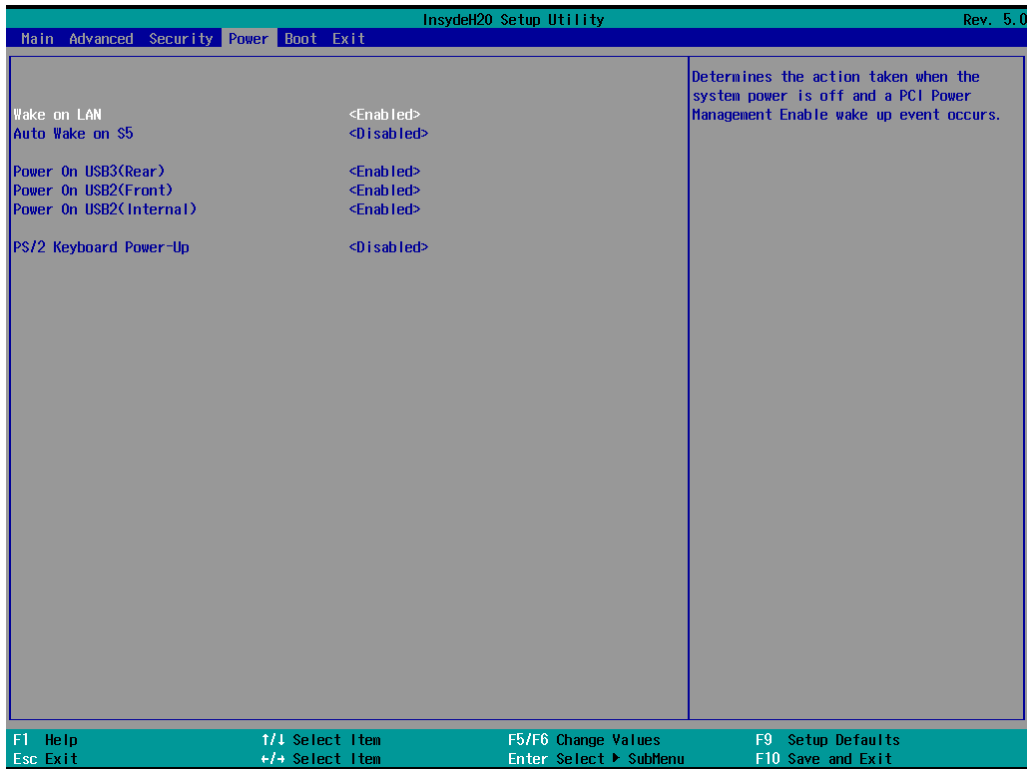

### Wake on LAN

This feature is used to wake the system by a LAN device from a remote host.

Options: Enabled (default), Disabled

### Auto Wake on S5

This item allows you to configure the computer to wake from S5 status. S5 stands for Soft Off, where the PSU remains engaged but power to all other parts of the system is cut. Auto-wake on S5 schedules a soft-reboot at certain periodic times that may be specified in the BIOS.

Options: Disabled (default); By Every Day (user specifies a regular daily time when the computer will power up); By Day of Month (user specifies a regular day each month when the computer will power up)

### Power On USB3 (Rear)

This item allows users to power on or power off the USB ports on the rear panel.

Options: Disabled, Enabled (default)



## Power On USB2 (Front)

This item allows users to power on or power off the USB ports on the front panel.

Options: Disabled, Enabled (default)

## Power On USB2 (Internal)

This item allows user to powers on or power off the internal USB port inside the computer.

Options: Disabled, Enabled (default)

## PS/2 Keyboard Power-Up

This item allows users to press CTRL+P to wake up the system that PSU remains engaged but power to all other parts of the system is cut

Options: Disabled (default), Enabled

## Boot Settings

The section allows users to configure boot settings.

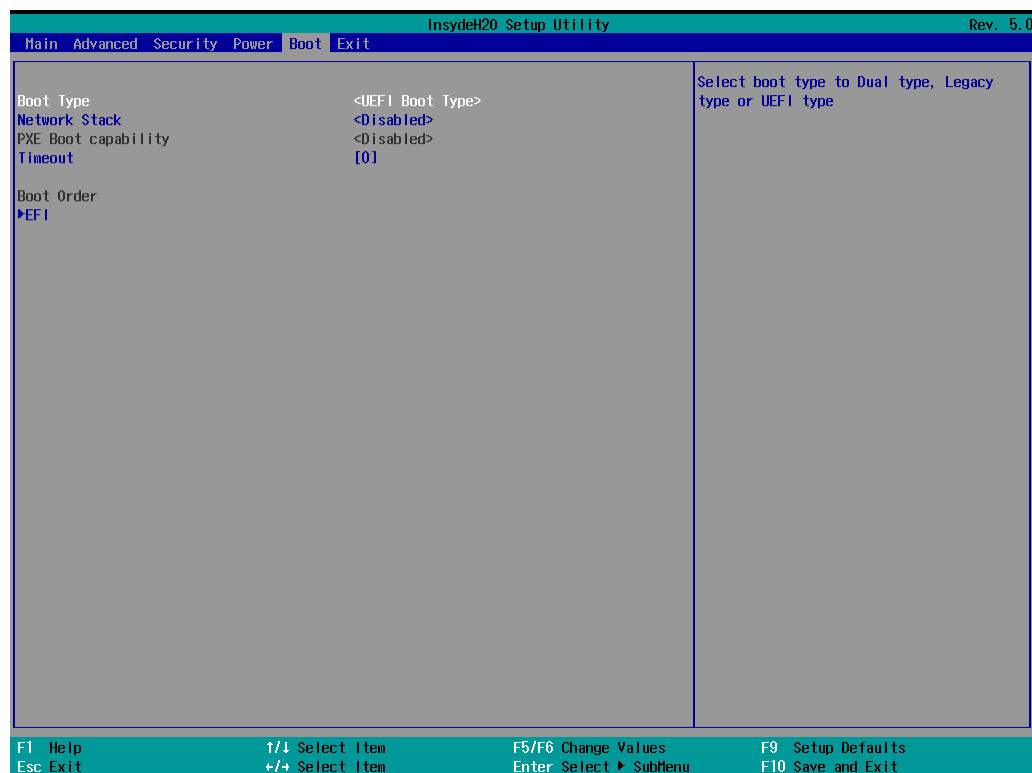

**NOTE** If you do not add any storage, you will not see the EFI option.

## Boot Type

This item allows you to enable/disable the quick boot function.

Options: Dual Boot Type, Legacy Boot Type, UEFI Boot Type (default)

## Network Stack

It deploys an Internet Protocol (IP) stack. The IP stack provides an application library to open/close connections to remote devices and send/receive data between the remote devices.

Options: Disabled (default), Enabled

## PXE Boot capability

PXE Booting is booting a system over a network. This item allows users to start PXE over IPv4 or IPv6

Options: Disabled (default), UEFI: IPv4, UEFI: IPv6, UEFI: IPv4/IPv6

## Timeout

This item allows users to set the number of second that the firmware will wait before booting the original default boot selection.

## EFI

This item allows users to select the boot order. Use F5 (move up) or F6 (move down) to change the value.

## Exit Settings

The section allows users to exit the BIOS environment.

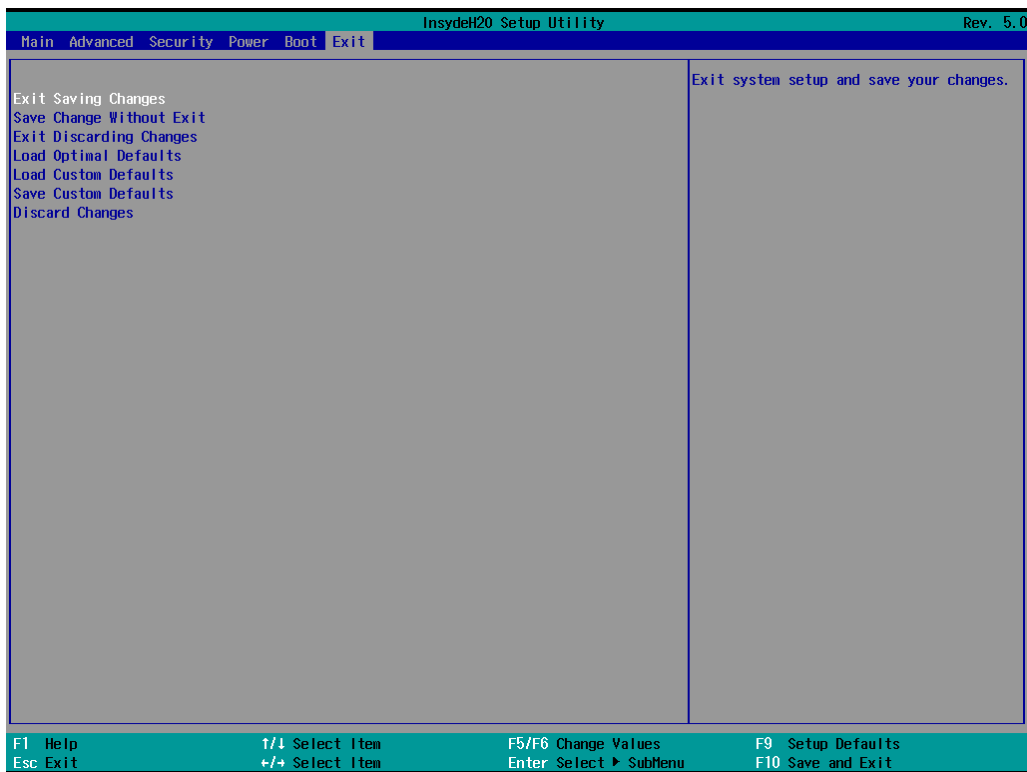

## Exit Saving Changes

This item allows you to exit the BIOS environment and save the values you have just configured.

Options: Yes (default), No

## Save Change Without Exit

This item allows you to save changes without exiting the BIOS environment.

Options: Yes (default), No

## Exit Discarding Changes

This item allows you to exit without saving any changes that might have been made to the BIOS.

Options: Yes (default), No

## Load Optimal Defaults

This item allows you to revert to the factory default BIOS values.

Options: Yes (default), No

## Load Custom Defaults

This item allows you to load custom default values for the BIOS settings.

Options: Yes (default), No

## Save Custom Defaults

This item allows you to save the current BIOS values as a “custom default” that may be reverted to at any time by the “load custom defaults” selection just above.

Options: Yes (default), No

## Discard Changes

This item allows you to discard all settings you have just configured.

Options: Yes (default), No

## Enable AMT

**NOTE** The AMT function is not supported for KL3 models.

To enter the BIOS setup utility, press the “F2” key while the system is booting up. The main **BIOS Setup** screen will appear. Five options will be available:

1. Select **Intel® Management Engine BIOS Extension** to enter the **AMT configuration**.

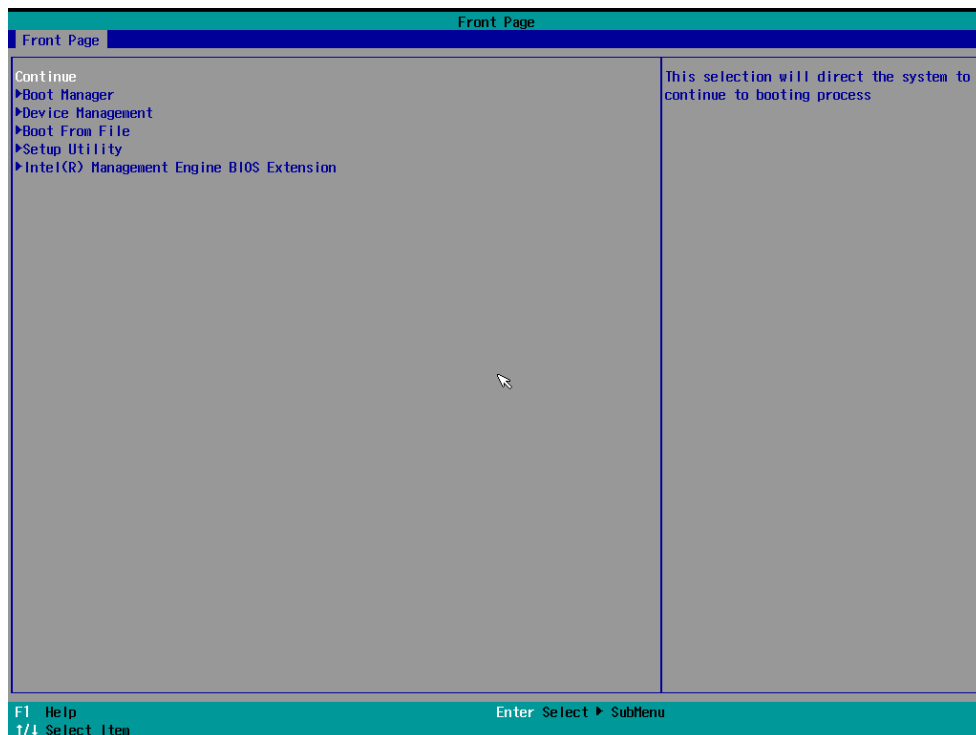

2. Press **<Enter>** to start the login procedure.

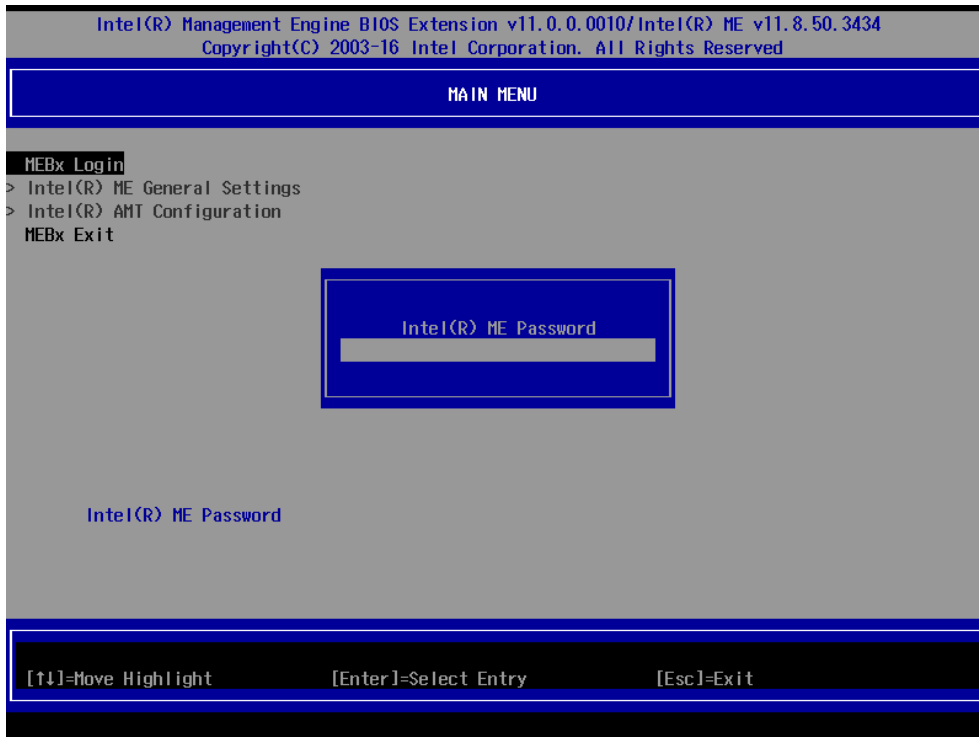

3. Type the default password: **admin**

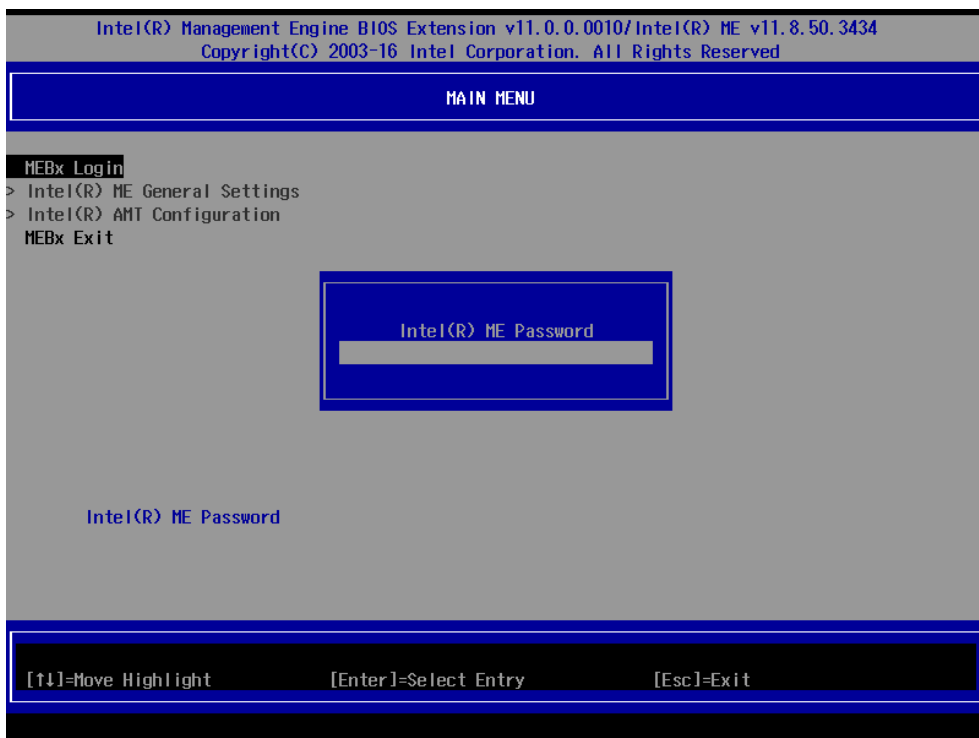

4. Type the new password. It must include both upper-case and lower-case characters, numbers, and special symbols. E.g., **Admin'12**.

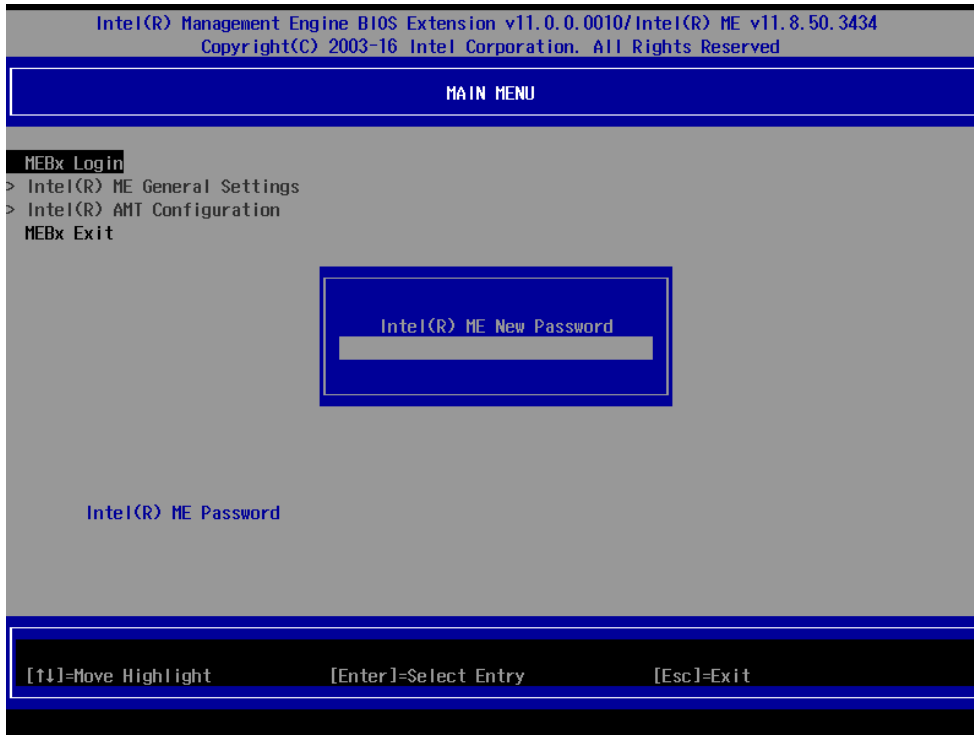

5. Select **Intel® AMT Configuration** to enable remote access without a local user present for consent, select **User Consent**, and then select **User Opt-in** and change the value to **None**.
6. Set static IP or DHCP by request.

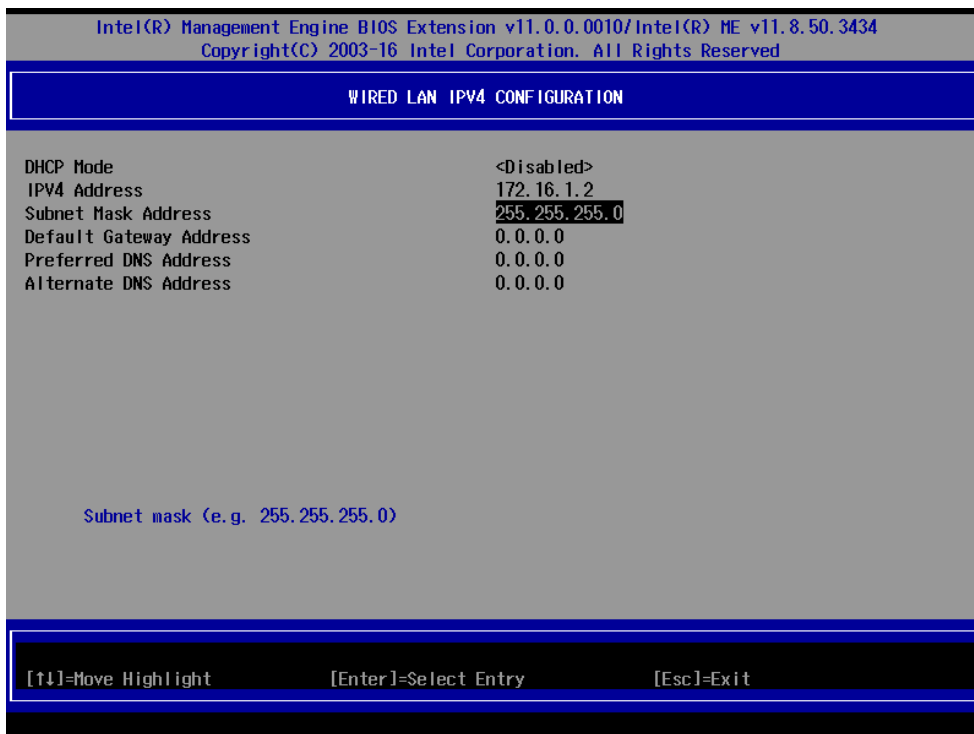

7. Set **Activate Network Access** to enable remote access capability.

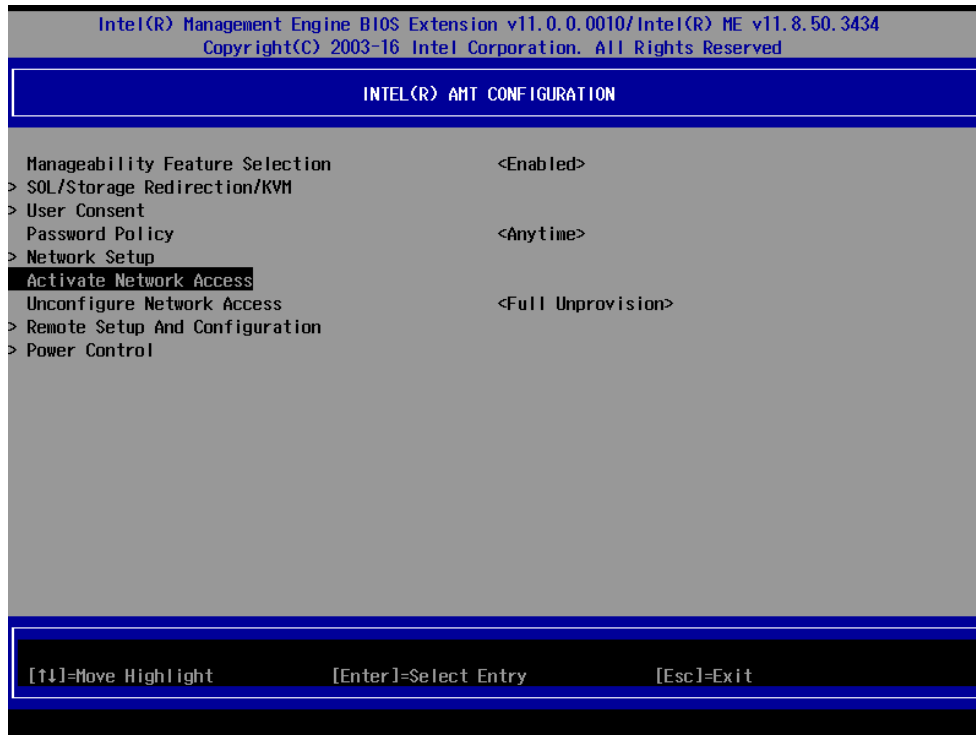

## Use AMT

You can use any of the available AMT tools to execute the remote management function. The easiest method is using a web browser.

1. Type the IP for your DA-820C that was configured in the AMT configuration with port **16992**. The AMT logon screen will appear.



- Click on "Log On" and type the username (**admin**) and password to log in and control the DA-820C remotely.

Intel® Active Management Technology

Computer:

System Status

Power	On
IP address	172.16.1.2
IPv6 address	Disabled
System ID	12345678-1234-5678-90ab-cddefaabbcc
Date	8/21/2014
Time	7:59 pm

Copyright © 2005-2011 Intel Corporation. All Rights Reserved. Intel® Active Management Technology firmware version: 8.0.0-build 1351

**NOTE** The DA-820C's AMT port is LAN1.

**NOTE** Refer to the Intel AMT Implementation and Reference Guide for details:  
[https://software.intel.com/sites/manageability/AMT\\_Implementation\\_and\\_Reference\\_Guide/default.htm?turl=WordDocuments%2Faccessingintelamtviathewebuiinterface.htm](https://software.intel.com/sites/manageability/AMT_Implementation_and_Reference_Guide/default.htm?turl=WordDocuments%2Faccessingintelamtviathewebuiinterface.htm)



# Upgrading the BIOS

This section describes how to upgrade the BIOS. However, note that it is easy to permanently damage the computer when upgrading the BIOS. We strongly recommend that you contact Moxa's technical support staff for assistance in order to obtain all the necessary tools and the most current advice before attempting to upgrade the BIOS on any Moxa device.

## Step 1: Create a Bootable USB Disk

Before upgrading the BIOS, every user should first create a bootable USB RAM drive as a system rescue device.

1. Search "format", then select **Create and format hard disk partitions**.

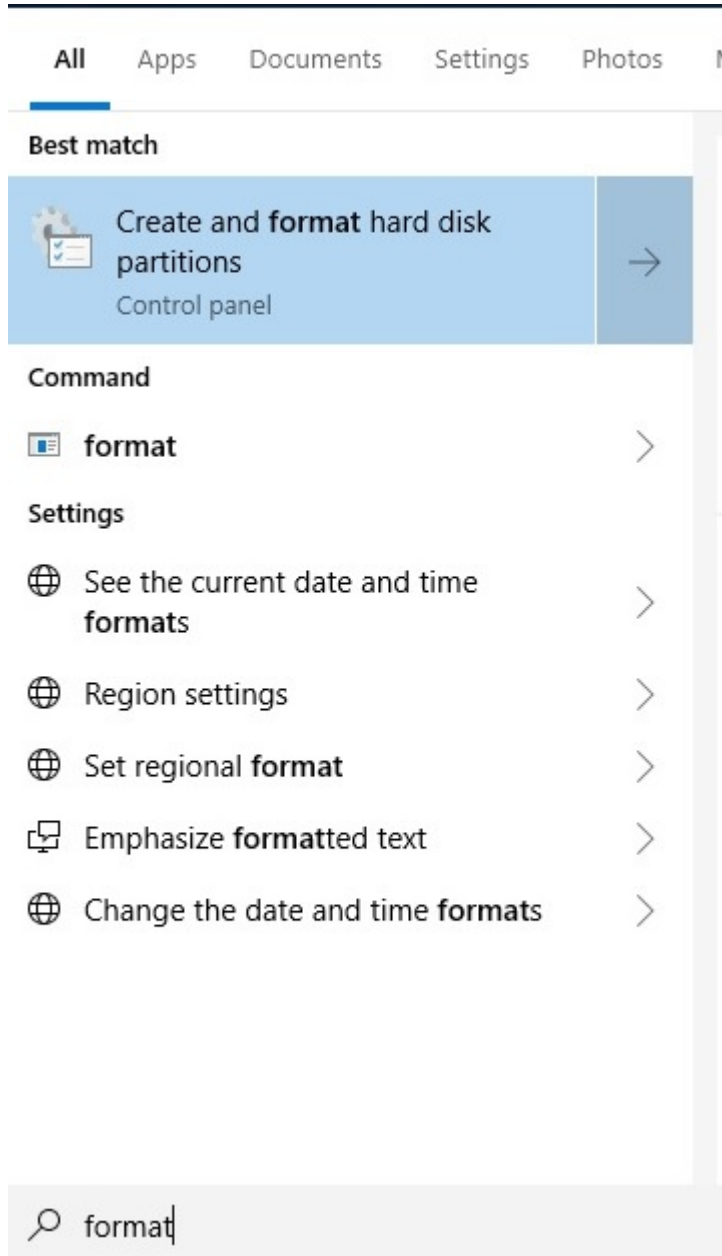

- Right click on the USB disk then select "Format".

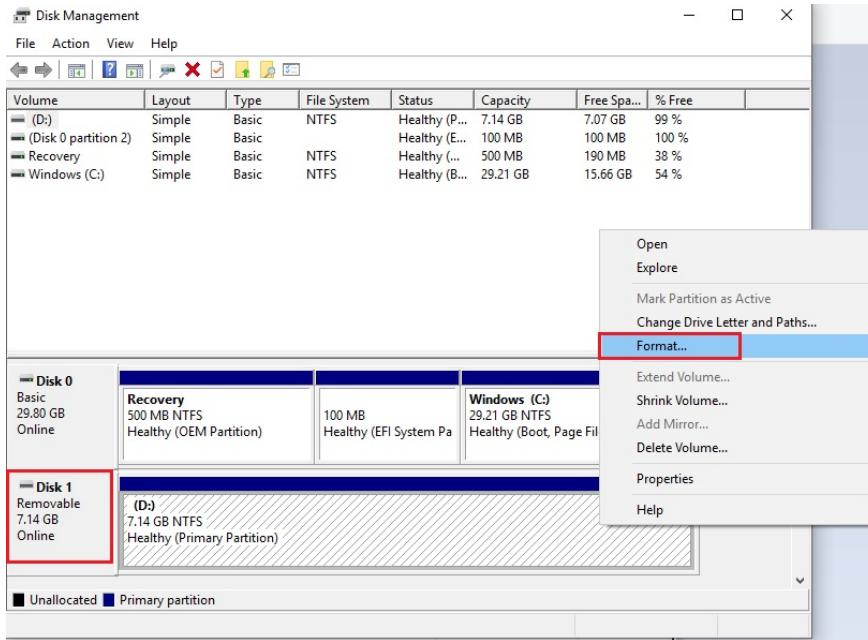

- Select "FAT32", and click OK to start formatting.

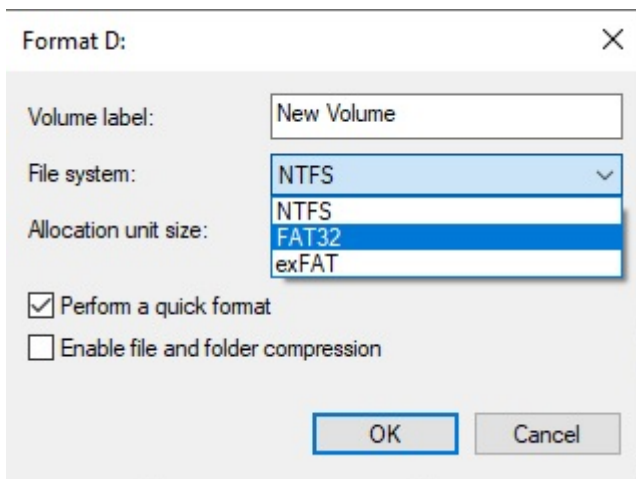

- After formatting the USB disk, download the "Shell.efi".
- Link to "<https://github.com/tianocore/edk2/branches>", select the latest branch.

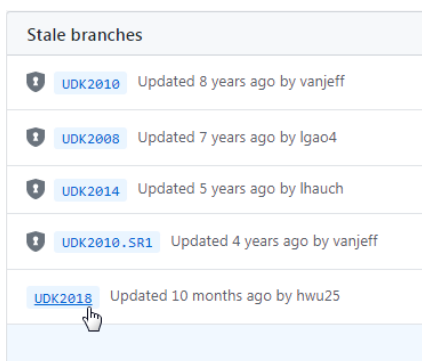

- As below path, download the "Shell.efi" then rename to "bootX64.efi".

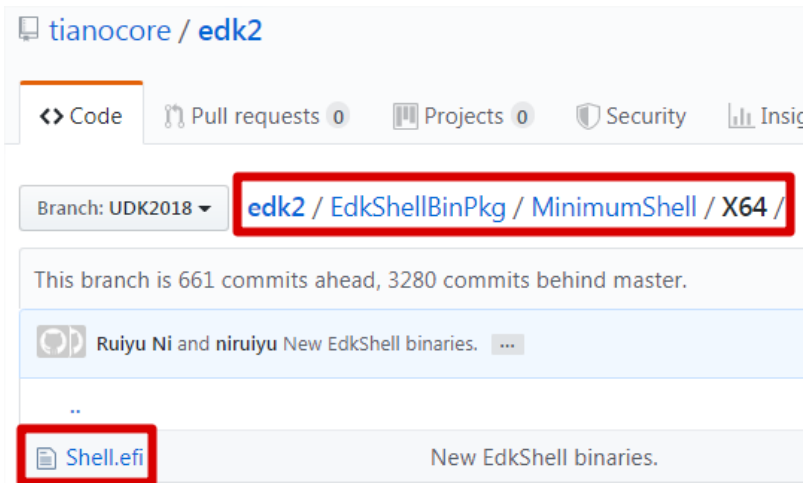

7. Copy the "bootX64.efi" to USB disk \efi\boot\bootX64.efi (Note: The folder should be created by absolute path as below).

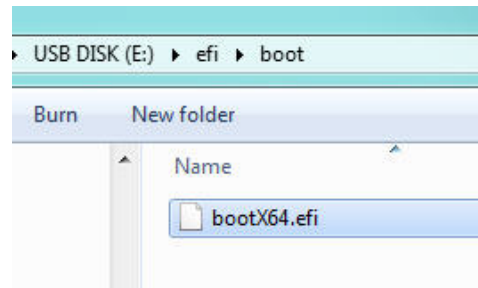
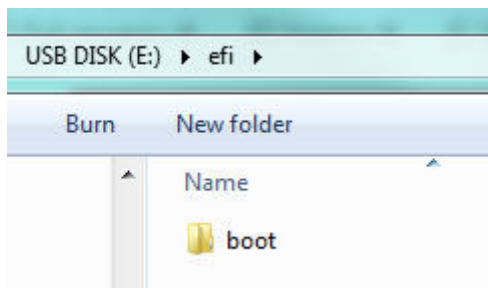

**Step 2: Prepare the Upgrade File**

You must use the BIOS upgrade installation file to upgrade the BIOS. Contact Moxa’s technical department for assistance.

1. Get the BIOS upgrade file. The file extension should be xxxx.efi
2. Copy the file to the Bootable USB Disk.

**Step 3: Run the upgrade program on the Computer**

1. Reboot the computer, and press F2 while booting up to go to the Boot Manager.
2. Select the USB Disk

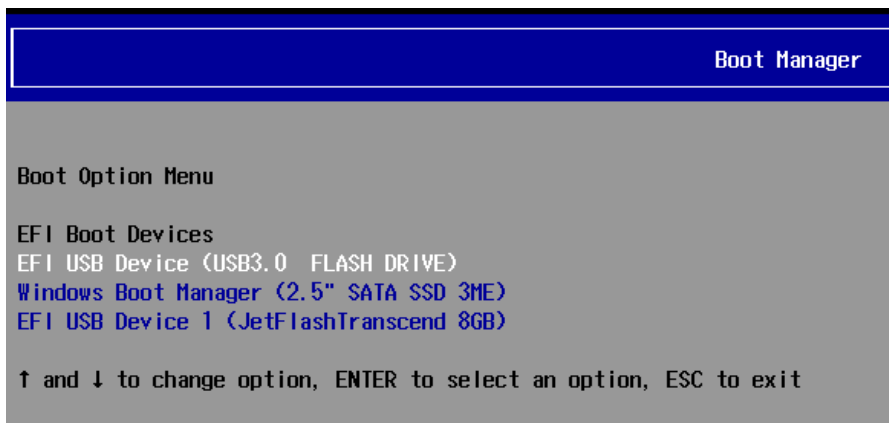



7. Go each **fsx** (x means number), then type **ls** to view the content of the boot device. If find the upgrade file, execute it

```
fs0:\> fs1:
fs1:\> ls
Directory of: fs1:\

06/27/19 11:43a <DIR>          16,384  efi
06/13/19 11:10a              17,974,704  820C100s16 efi
1 File(s) 17,974,704 bytes
1 Dir(s)
```

**ATTENTION**

Do NOT switch off the power supply during the BIOS upgrade, since doing so may cause the system to crash.

# Safety Installation Instructions

---

## A. RTC Battery Warning



### ATTENTION

There is a risk of explosion if the wrong type of battery is used. To avoid this potential danger, always be sure to use the correct type of battery. Contact the Moxa RMA service team if you need to replace your battery.

### Caution

There is a risk of explosion if the battery is replaced by an incorrect type. Dispose of used batteries according to the instructions on the battery.

## B. Fuse Warning

**CAUTION:** For continued protection against fire, replace only with the same type and rating of fuse.

## C. Rackmount Warning

The following or similar rackmount instructions are included with the installation instructions:

**(1) Elevated Operating Ambient:** If installed in a closed or multi-unit rack assembly, the operating ambient temperature of the rack environment may be greater than the room ambient temperature. Therefore, consideration should be given to installing the equipment in an environment compatible with the maximum ambient temperature (T<sub>ma</sub>) specified by the manufacturer.

**(2) Reduced Air Flow:** Installation of the equipment in a rack should be such that the amount of air flow required for safe operation of the equipment is not compromised.

**(3) Mechanical Loading:** Mounting of the equipment in the rack should be such that a hazardous condition is not achieved due to uneven mechanical loading.

**(4) Circuit Overloading:** Consideration should be given to the connection of the equipment to the supply circuit and the effect that overloading of the circuits might have on overcurrent protection and supply wiring. Appropriate consideration of equipment nameplate ratings should be used when addressing this concern.

**(5) Reliable Grounding:** Reliable grounding of rack-mounted equipment should be maintained. Particular attention should be given to supply connections other than direct connections to the branch circuit (e.g., by using power strips).