

# MAT-WDB-DA-RM-2-0203-1m 系列

MIMO 2x2、2.4/5 GHz 時 2/3 dBi、雙頻桌上型天線、RP-SMA (公)，1 m 纜線



## 特色與優點

- 小尺寸容易安裝
- 桌面安裝
- RP-SMA (公) 接頭

## 簡介

MAT-WDB-CA-RM-2-0203-1m 天線是輕巧型 MIMO 2x2 雙頻桌上型天線，配備 RP-SMA (公) 接頭。此天線可用於 2.4 GHz 和 5 GHz 頻率，提供 2/3 dBi 的天線增益，並配有 1 公尺纜線。

## 現場方向圖

連接埠 1 頻率：2.4 GHz

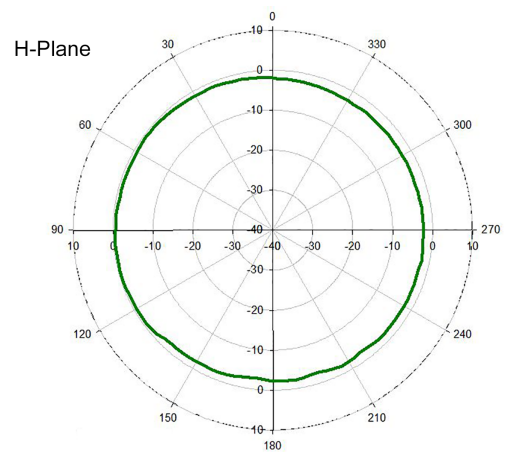
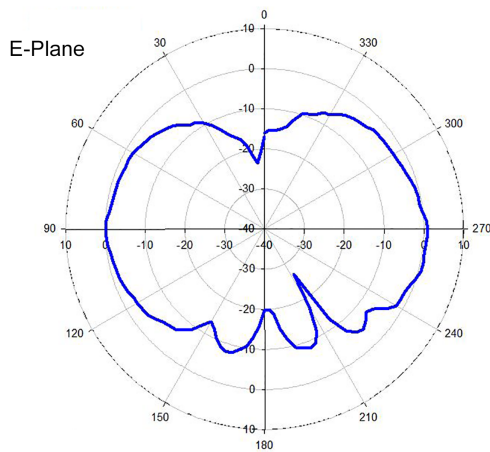

### 連接埠 2 頻率 : 2.4 GHz

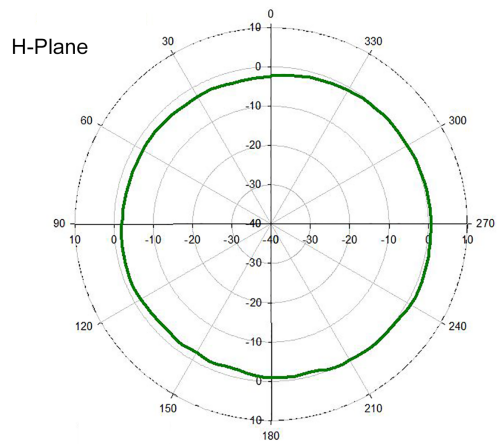
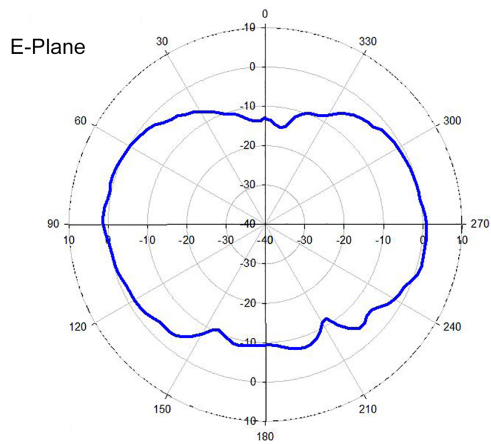

### 連接埠 1 頻率 : 5 GHz

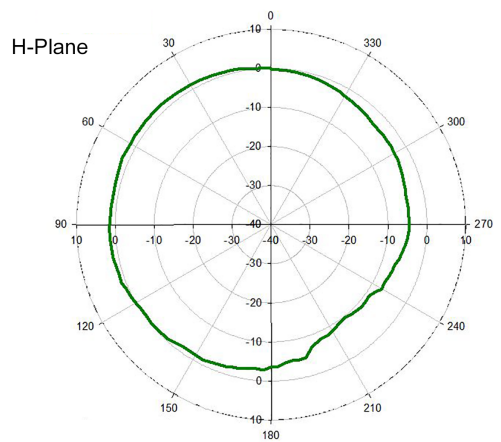
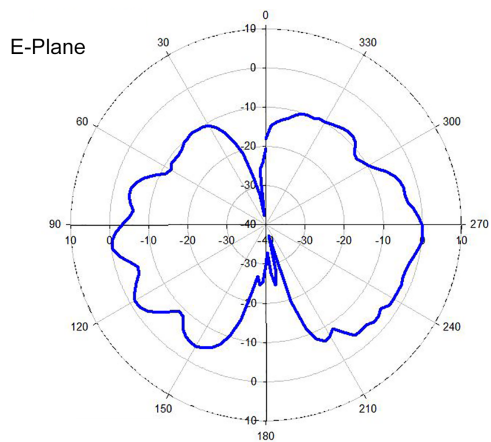

### 連接埠 2 頻率 : 5 GHz

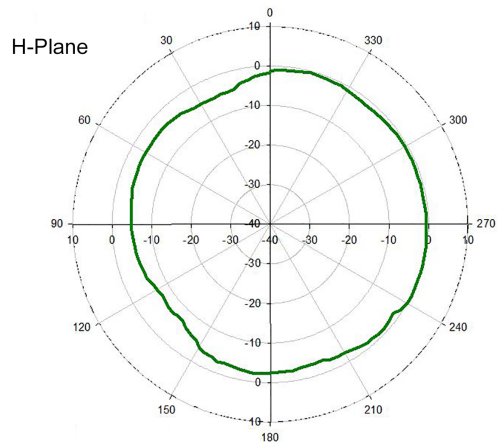
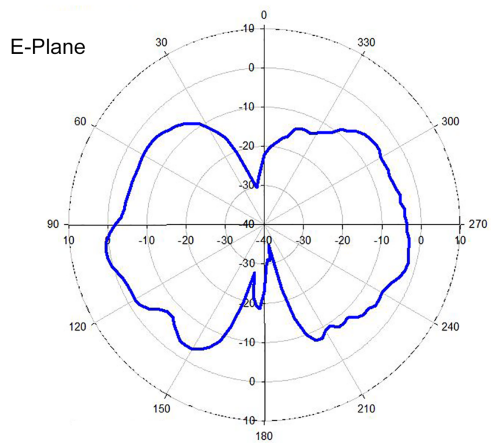

## 規格

### Antenna Characteristics

Frequency	2.4 to 2.5, 4.9 to 5.85 GHz
Antenna Type	MIMO 2x2, Omni-directional
Typical Antenna Gain	2/3 dBi
Connector	RP-SMA (male)
Impedance	50 ohms

Polarization	Linear, Vertical
HPBW/Horizontal	360/114°
HPBW/Vertical	75/54°
V.S.W.R.	2:1 max.
Power Handling	2 W (max.)

#### Physical Characteristics

Weight	156 g (0.34 lb)
Length (including RF cable)	194.3 mm (7.65 in)
IP Rating	IP55
Radome Color	Black
Radome Material	PC-1250G
Installation	Desktop Mount
Cable	RG-174
Cable Length	1 m

#### Environmental Limits

Operating Temperature	-40 to 75°C (-40 to 167°F)
Storage Temperature (package included)	-40 to 75°C (-40 to 167°F)
Ambient Relative Humidity	5 to 95% (30°C, non-condensing)

#### Warranty

Warranty Period	1 year
Details	See <a href="http://www.moxa.com/tw/warranty">www.moxa.com/tw/warranty</a>

# 尺寸

Unit: mm

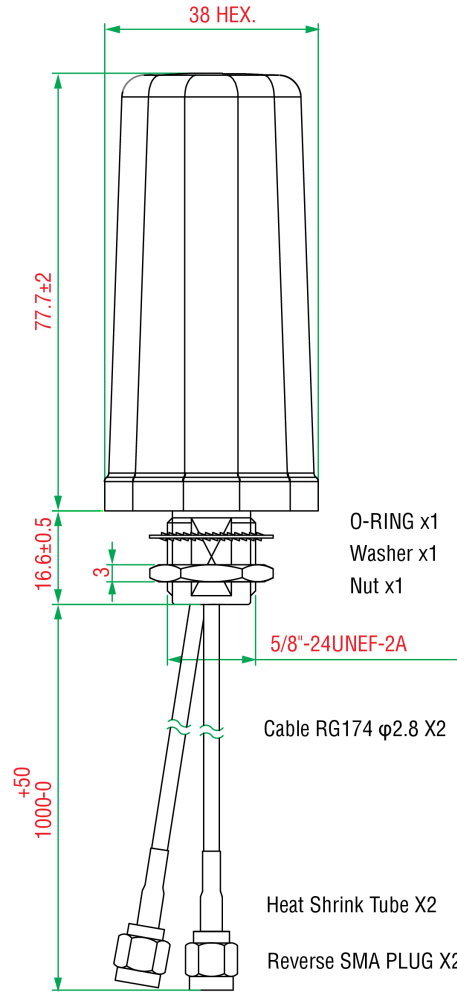

## 訂購資訊

Model Name	Frequency	Antenna Type	Antenna Gain	Connector
MAT-WDB-DA-RM-2-0203-1m	2.4 to 2.5, 4.9 to 5.85 GHz	MIMO 2x2, Omni-directional	2/3 dBi	RP-SMA (male)

© Moxa Inc. 版權所有.2018 年 11 月 12 日更新。

未經 Moxa Inc. 明確書面許可，不得以任何方式複製或使用本文件及其任何部分。產品規格如有變更，恕不另行通知。請至本公司官網了解最新的產品資訊。