

EDS-2016-ML Series Quick Installation Guide

Moxa EtherDevice Switch

Version 1.2, March 2021

Technical Support Contact Information
www.moxa.com/support

MOXA®

© 2021 Moxa Inc. All rights reserved.

P/N: 1802020160012



Overview

The EDS-2016-ML Series industrial Ethernet switches have 16 10/100M ports and up to two optical fiber ports with SC/ST connector type options.

The EDS-2016-ML provides 12/24/48 VDC redundant power inputs, and the switches are available with a standard operating temperature range from -10 to 60°C, or with a wide operating temperature range from -40 to 75°C. The switches are rugged enough to operate reliably in harsh industrial environments.

To provide greater versatility for use with applications from different industries, the EDS-2016-ML also allow users to enable or disable broadcast storm protection, Quality of Service (QoS) function, and port break alarm function with DIP switches on the outer panel.

The EDS-2016-ML switches can be easily installed with DIN-Rail mounting as well as distribution boxes. The DIN-rail mounting capability and IP30 metal housing with LED indicators make the plug-and-play EDS-2016-ML switches reliable and easy to use.

NOTE Throughout this Quick Installation Guide, we use **EDS** as an abbreviation for Moxa EtherDevice Switch:

EDS = Moxa EtherDevice Switch



ATTENTION

This device complies with part 15 of FCC Rules. Operation is subject to the following two conditions: (1) This device may not cause harmful interference, and (2) this device must accept any interference received, including interference that may cause undesired operation.

Package Checklist

Your EDS is shipped with the following items. If any of these items are missing or damaged, please contact your customer service representative for assistance.

- Moxa EtherDevice™ Switch
- Quick installation guide (printed)
- Warranty card
- Protective caps for unused ports

Features

High Performance Network Switching Technology

- 10/100BaseT(X) auto-negotiation speed, full/half duplex mode, auto MDI/MDI-X connection, and 100BaseFX (SC/ST type, Multi/Single mode).
- IEEE 802.3 for 10BaseT, IEEE 802.3u for 100BaseT(X) and 100BaseFX.
- IEEE 802.1p for Quality of Service (QoS) traffic prioritized function.
- Store-and-forward switching process type.

Industrial-grade Reliability

- Power failure, port break alarm by relay output
- Redundant dual DC power inputs
- Broadcast storm protection to prevent network devices from crashing

Rugged Design

- Operating temperature range from -10 to 60°C, or extended operating temperature from -40 to 75°C for “-T” models
- IP30, rugged high-strength case
- DIN-rail or panel mounting ability



WARNING

The power for this product is intended to be supplied by a Listed Power Supply, with output marked LPS, and rated to deliver 12 to 48 VDC at a maximum of 0.62 A.

The DC jack should be used with an LPS unit that is rated to deliver 12 to 48 VDC at a minimum of 1.1A. The product should not be disassembled by operators or service people.

Panel Layout of EDS-2016-ML (Standard type)

Front Panel View

Top Panel View

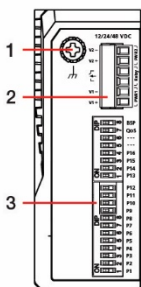
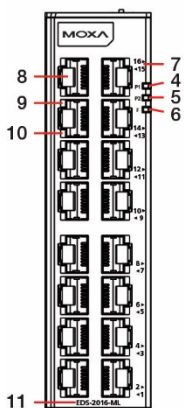

1. Grounding screw
2. Terminal block for power input (PWR1, PWR2) and relay output
3. DIP switch
4. Power input PWR1 LED
5. Power input PWR2 LED
6. Fault LED
7. Port number
8. 10/100 BaseT(X) Port
9. TP port's 100 Mbps LED
10. TP port's 10 Mbps LED
11. Model name

Panel Layout of EDS-2016-ML (SC type)

Front Panel View

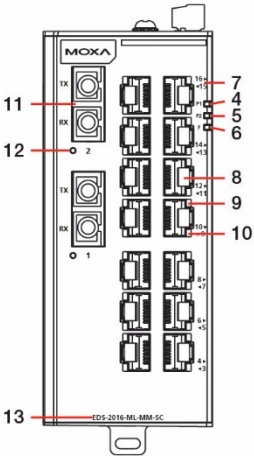

Top Panel View

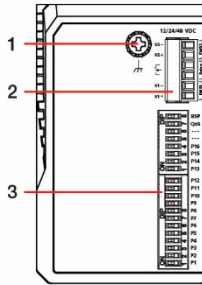

1. Grounding screw
2. Terminal block for power input (PWR1, PWR2) and relay output
3. DIP switch
4. Power input PWR1 LED
5. Power input PWR2 LED
6. Fault LED
7. Port number
8. 10/100 BaseT(X) Port
9. TP port's 100 Mbps LED
10. TP port's 10 Mbps LED
11. 100BaseFX Port
12. FX port's 100 Mbps LED
13. Model name

Panel Layout of EDS-2016-ML (ST type)

Front Panel View

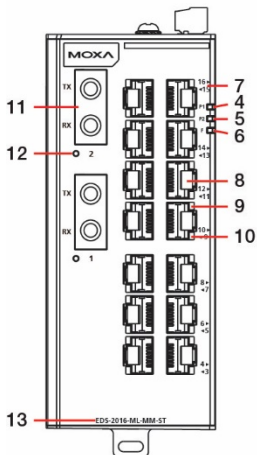

Top Panel View

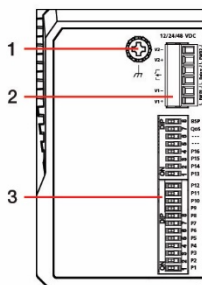

1. Grounding screw
2. Terminal block for power input (PWR1, PWR2) and relay output
3. DIP switch
4. Power input PWR1 LED
5. Power input PWR2 LED
6. Fault LED
7. Port number
8. 10/100 BaseT(X) Port
9. TP port's 100 Mbps LED
10. TP port's 10 Mbps LED
11. 100BaseFX Port
12. FX port's 100 Mbps LED
13. Model name

Mounting Dimensions

EDS-2016-ML Series

Unit = mm (inch)

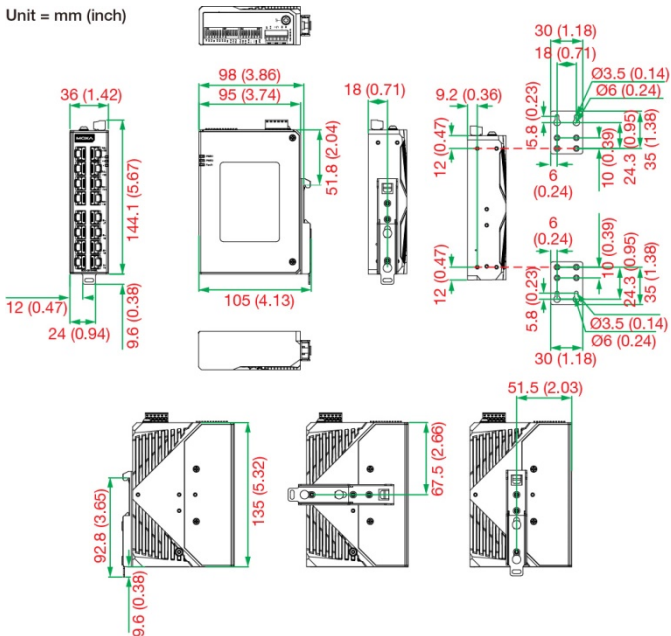

EDS-2016-ML Fiber Series

Unit: mm (inch)

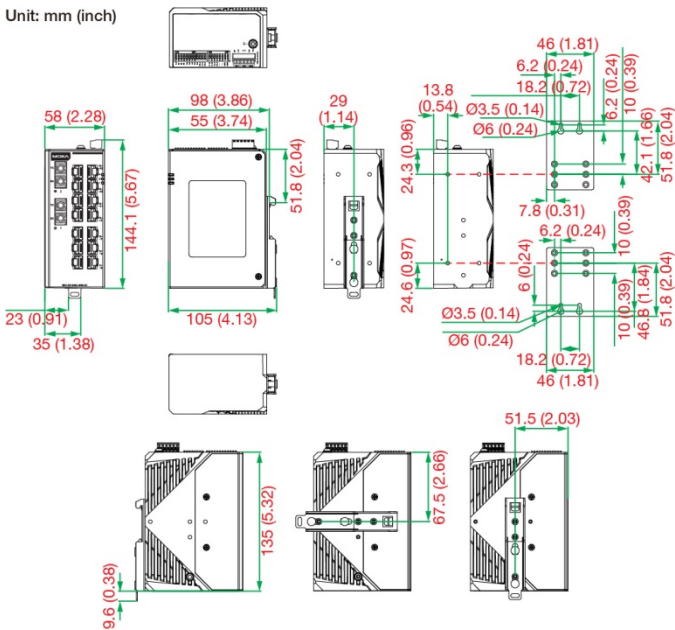

DIN-Rail Mounting

There are two options for DIN-rail mounting that can be used on an EDS. Option 1 is the default type when the product is shipped.

Option 1 (Default):

When shipped, the metal DIN-rail mounting kit is fixed to the back panel of the EDS. Mount the EDS on the corrosion-free mounting rail that adheres to the EN 60715 standard.

Suggested Installation Method

STEP 1:

Insert the upper lip of the DIN-rail kit into the mounting rail.

STEP 2:

Press the device towards the mounting rail until it snaps into place.

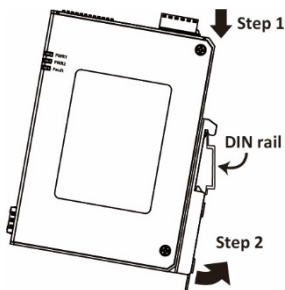

Suggested Removal Method

STEP 1:

Pull down the latch on the DIN-rail kit with a screwdriver.

STEP 2:

Slightly pull the device forward and lift up to remove it from the mounting rail.

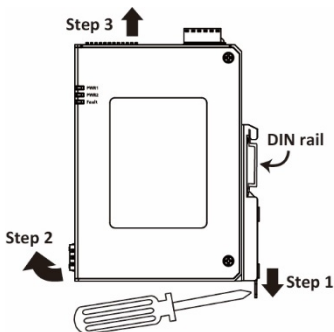

Option 2 (when side cabling is needed):

The metal DIN-rail mounting kit can be fixed to the side panel (mold side) of the EDS (horizontal or vertical). Mount the EDS on the corrosion-free mounting rail that adheres to the EN 60715 standard.

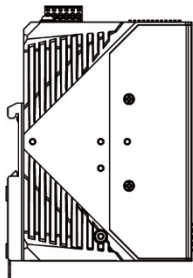

Default

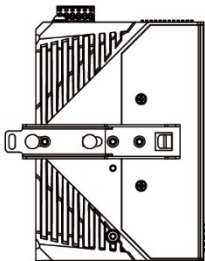

Horizontal

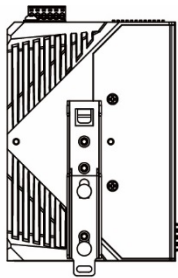

Vertical

Suggested Installation Method

STEP 1:

Detach the metal DIN-rail mounting kit from the back panel and attach it to the side panel (mold side) in either the horizontal or vertical direction as indicated in the figure below.

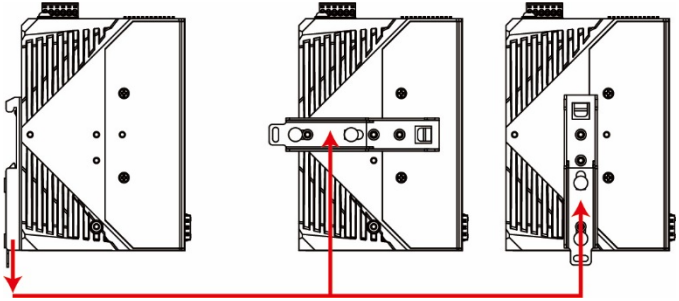

STEP 2:

Insert the upper lip of the DIN-rail kit into the mounting rail.

STEP 3:

Press the device towards the mounting rail until it snaps into place.

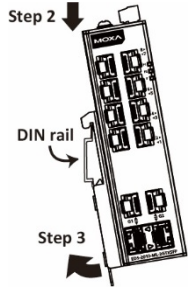

Suggested Removal Method

STEP 1:

Pull down the latch on the DIN-rail kit with a screwdriver.

STEP 2:

Slightly pull the device forward and lift up to remove it from the mounting rail.

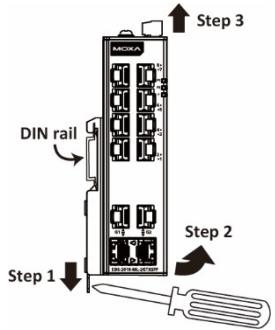

NOTE Screws that are used to fix the DIN-rail kit on the EDS should be securely fastened before mounting on the mounting rail. Please make sure that if you remove the DIN-rail, it must be securely fastened when it is reattached.

Wall Mounting (optional)

For some applications, you will find it convenient to mount EDS on the wall, as illustrated below.

STEP 1:

Remove the aluminum DIN-Rail attachment plate from EDS's rear panel, and then attach the wall mount plates, as shown in the diagram below.

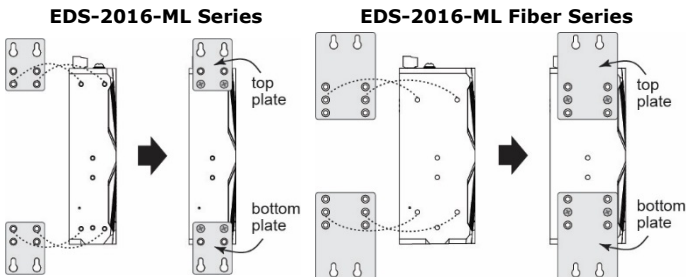

STEP 2:

Mounting the EDS on the wall requires 4 screws. Use the switch, with wall mount plates attached, as a guide to mark the correct locations of the 4 screws. The heads of the screws should be less than 6.0 mm in diameter, and the shafts should be less than 3.5 mm in diameter, as shown in the figure at the right.

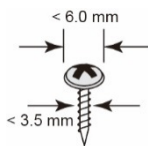

NOTE Before tightening screws into the wall, make sure the screw head and shank size are suitable by inserting the screw into one of the keyhole-shaped apertures of the Wall Mounting Plates.

Do not screw the screws in all the way—leave about 2 mm to allow room for sliding the wall mount panel between the wall and the screws.

STEP 3:

Once the screws are fixed in the wall, insert the four screw heads through the large parts of the keyhole-shaped apertures, and then slide EDS downwards, as indicated. Tighten the four screws for added stability.

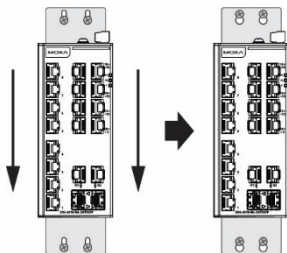

WARNING

External metal parts can be hot. Take necessary precautions if it is necessary to touch.

Wiring Requirements



WARNING

Do not disconnect modules or wires unless the power supply has been switched off or the area is known to be non-hazardous. The devices may only be connected to the supply voltage shown on the type plate.

The devices are designed for operation with a Safety Extra-Low Voltage. Thus, they may only be connected to the supply voltage connections and to the signal contact with the Safety Extra-Low Voltages (SELV) in compliance with IEC950/ EN60950/ VDE0805.



WARNING

Safety First!

Be sure to disconnect the power cord before installing and/or wiring your Moxa EtherDevice Switch.

Calculate the maximum possible current in each power wire and common wire. Observe all electrical codes dictating the maximum current allowable for each wire size.

If the current goes above the maximum ratings, the wiring could overheat, causing serious damage to your equipment.

You should also pay attention to the following items:

- Use separate paths to route wiring for power and devices. If power wiring and device wiring paths must cross, make sure the wires are perpendicular at the intersection point.
NOTE: Do not run signal or communications wiring and power wiring in the same wire conduit. To avoid interference, wires with different signal characteristics should be routed separately.
- You can use the type of signal transmitted through a wire to determine which wires should be kept separate. The rule of thumb is that wiring that shares similar electrical characteristics can be bundled together.
- Keep input wiring and output wiring separated.
- It is strongly advised that you label wiring to all devices in the system when necessary.

Grounding Moxa EtherDevice Switch

Grounding and wire routing help limit the effects of noise due to electromagnetic interference (EMI). Run the ground connection from the ground screw to the grounding surface prior to connecting devices.

A 4 mm² conductor must be used when a connection to the external grounding screw is utilized.



ATTENTION

This product is intended to be mounted to a well-grounded mounting surface, such as a metal panel.

Wiring the Alarm Contact

The Alarm Contact consists of the two middle contacts of the terminal block on the EDS's top panel. You may refer to the next section for detailed instructions on how to connect the wires to the terminal block connector, and how to attach the terminal block connector to the terminal block receptor. In this section, we explain the meaning of the two contacts used to connect the Alarm Contact.

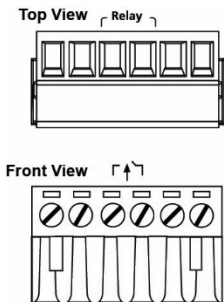

FAULT: The two middle contacts of the 6-contact terminal block connector are used to detect both power faults and port faults. The two wires attached to the Fault contacts form an open circuit when:

1. The EDS has lost power from one of the DC power inputs.
OR
2. One of the ports for which the corresponding PORT ALARM DIP Switch is set to ON is not properly connected.

If neither of these two conditions is satisfied, the Fault circuit will be closed.

Wiring the Redundant Power Inputs

The top two contacts and the bottom two contacts of the 6-contact terminal block connector on the EDS's top panel are used for the EDS's two DC inputs. Top and front views of one of the terminal block connectors are shown here.

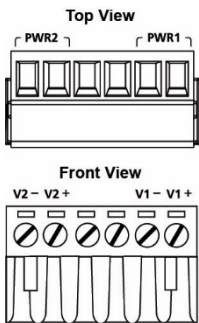

STEP 1:

Insert the negative/positive DC wires into the V-/V+ terminals.

STEP 2:

To keep the DC wires from pulling loose, use a small flat-blade screwdriver to tighten the wire-clamp screws on the front of the terminal block connector.

STEP 3:

Insert the plastic terminal block connector prongs into the terminal block receptor, which is located on the EDS's top panel.



ATTENTION

Before connecting the EDS to the DC power inputs, make sure the DC power source voltage is stable.



ATTENTION

One individual conductor in a clamping point with 28-14 AWG wire size, and a torque value of 1.7 lb-in should be used.

Communication Connections

The EDS-2016-ML models have 14 or 16 10/100BaseT(X) Ethernet ports, and 0 or 2 100BaseFX (SC/ST-type connector) fiber ports.

10/100BaseT(X) Ethernet Port Connection

The 10/100BaseT(X) ports located on the EDS's front panel are used to connect to Ethernet-enabled devices.

Below we show pinouts for both MDI (NIC-type) ports and MDI-X (HUB/Switch-type) ports, and also show cable wiring diagrams for straight-through and cross-over Ethernet cables.

10/100Base T(x) RJ45 Pinouts

MDI Port Pinouts

Pin	Signal
1	Tx+
2	Tx-
3	Rx+
6	Rx-

MDI-X Port Pinouts

Pin	Signal
1	Rx+
2	Rx-
3	Tx+
6	Tx-

8-pin RJ45

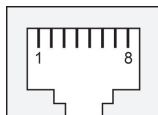

RJ45 (8-pin) to RJ45 (8-pin) Straight-through Cable Wiring

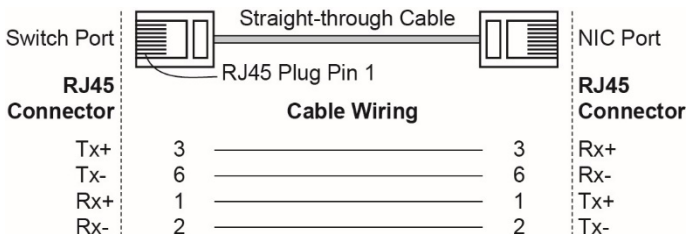

RJ45 (8-pin) to RJ45 (8-pin) Cross-over Cable Wiring

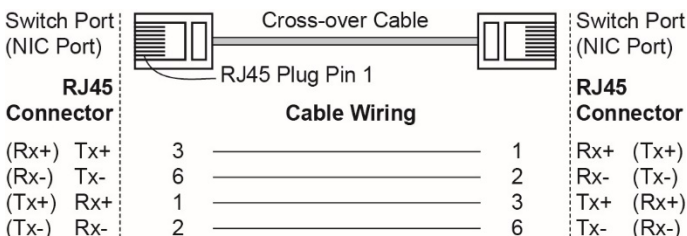

100BaseFX Ethernet Port Connection

The concept behind the SC/ST port and cable is very straightforward. Suppose you are connecting devices I and II. Contrary to electrical signals, optical signals do not require a circuit in order to transmit data. Consequently, one of the optical lines is used to transmit data from device I to device II, and the other optical line is used to transmit data from device II to device I, for full-duplex transmission.

All you need to remember is to connect the Tx (transmit) port of device I to the Rx (receive) port of device II, and the Rx (receive) port of device I to the Tx (transmit) port of device II. If you make your own cable, we suggest labeling the two sides of the same line with the same letter (A-to-A and B-to-B, as shown below, or A1-to-A2 and B1-to-B2).

SC-Port Pinouts

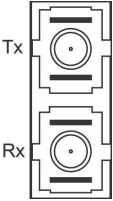

SC-Port to SC-Port Cable Wiring

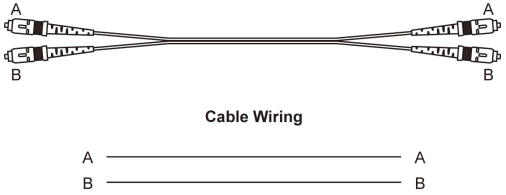

ST-Port Pinouts



ST-Port to ST-Port Cable Wiring

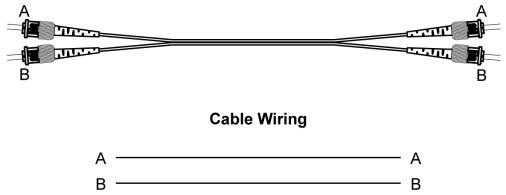

ATTENTION

This is a Class 1 Laser/LED product. To avoid causing serious damage to your eyes, do not stare directly into the Laser Beam.

Redundant Power Inputs

Both power inputs can be connected simultaneously to live DC power sources. If one power source fails, the other live source acts as a backup, and automatically supplies all of EDS's power needs.

Alarm Contact

The Moxa EtherDevice Switch has one Alarm Contact located on the top panel. For detailed instructions on how to connect the Alarm Contact power wires to the two middle contacts of the 6-contact terminal block connector, see the Wiring the Alarm Contact section on page 10. A typical scenario would be to connect the Fault circuit to a warning light located in the control room. The light can be set up to switch on when a fault is detected.

The Alarm Contact has two terminals that form a Fault circuit for connecting to an alarm system. The two wires attached to the Fault contacts form an open circuit when (1) EDS has lost power from one of the DC power inputs, or (2) one of the ports for which the corresponding PORT ALARM DIP Switch is set to ON is not properly connected.

If neither of these two conditions occurs, the Fault circuit will be closed.

NOTE The DIP settings will be activated when the device is powered on the next time.

DIP Switch Settings

EDS-2016-ML Series DIP Switches

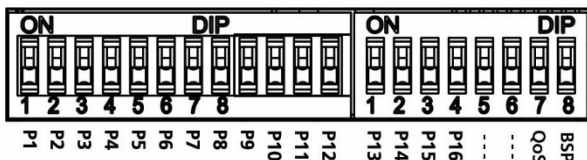

DIP Switch	Setting	Description																				
Port Alarm Function P1 to P16	ON	Enables the corresponding PORT Alarm. If the port's link fails, the relay will form an open circuit and the fault LED will light up.																				
	OFF	Disables the corresponding PORT Alarm. The relay will form a closed circuit and the Fault LED will never light up.																				
Quality of Service (QoS)	ON	Enable the Quality of Service to handle packet priorities in four WRR queues. <i>QoS and ToS/DSCP priority mapping matrix in each queue</i> <table border="1" data-bbox="393 873 984 1059"> <thead> <tr> <th>CoS Priority</th> <th>7,6</th> <th>5,4</th> <th>3,2</th> <th>1,0</th> </tr> </thead> <tbody> <tr> <td>ToS/DSCP Priority</td> <td>63 to 48</td> <td>47 to 32</td> <td>31 to 16</td> <td>15 to 0</td> </tr> <tr> <td>Queues</td> <td>3</td> <td>2</td> <td>1</td> <td>0</td> </tr> <tr> <td>WRR</td> <td>8</td> <td>4</td> <td>2</td> <td>1</td> </tr> </tbody> </table>	CoS Priority	7,6	5,4	3,2	1,0	ToS/DSCP Priority	63 to 48	47 to 32	31 to 16	15 to 0	Queues	3	2	1	0	WRR	8	4	2	1
	CoS Priority	7,6	5,4	3,2	1,0																	
ToS/DSCP Priority	63 to 48	47 to 32	31 to 16	15 to 0																		
Queues	3	2	1	0																		
WRR	8	4	2	1																		
OFF	Disable the Quality of Service.																					
Broadcast Storm Protection (BSP)	ON	Enables broadcast storm protection (at a maximum of 2000 broadcast packets per second) in the EDS switch for all ports.																				
	OFF	Disables broadcast storm protection.																				

LED Indicators

The front panel of the Moxa EtherDevice Switch contains several LED indicators. The function of each LED is described in the table below.

LED	Color	State	Description
System LEDs			
PWR1	Amber	On	Power is being supplied to the main module's power input PWR1.
		Off	Power is not being supplied to the main module's power input PWR1.
PWR2	Amber	On	Power is being supplied to the main module's power input PWR2.
		Off	Power is not being supplied to the main module's power input PWR2.
FAULT	Red	On	When the corresponding PORT alarm is enabled, and the port's link is inactive.
		Off	When the corresponding PORT alarm is enabled and the port's link is active, or when the corresponding PORT alarm is disabled.

LED	Color	State	Description
100M Fiber LED	Green	On	TP port's 100Mbps link is active.
		Blinking	Data is being transmitted at 100Mbps.
		Off	TP port's 100Mbps link is inactive.
10M/100M Copper top LED	Green	On	TP port's 100Mbps link is active.
		Blinking	Data is being transmitted at 100Mbps.
		Off	TP port's 100Mbps link is inactive.
10M/100M Copper bottom LED	Green	On	TP port's 10Mbps link is active.
		Blinking	Data is being transmitted at 10Mbps.
		Off	TP port's 10Mbps link is inactive.

Auto MDI/MDI-X Connection

The Auto MDI/MDI-X function allows users to connect the EDS's 10/100BaseT(X) ports to any kind of Ethernet device, without paying attention to the type of Ethernet cable being used for the connection. This means that you can use either a straight-through cable or cross-over cable to connect the EDS to Ethernet devices.

Dual Speed Functionality and Switching Moxa EDS's 10/100 Mbps switched RJ45 port auto negotiates with the connected device for the fastest data transmission rate supported by both devices. All models of Moxa EtherDevice Switch are plug-and-play devices, so that software configuration is not required at installation, or during maintenance. The half/full duplex mode for the switched RJ45 ports is user dependent and changes (by auto-negotiation) to full or half duplex, depending on which transmission speed is supported by the attached device.

Fiber Ports

Moxa EDS's fiber switched ports operate at a fixed 100 Mbps speed and full-duplex mode to provide the best performance. The fiber ports are factory-built as either a multi-mode or single-mode SC/ST connector.

Consequently, you should use fiber cables that have SC/ST connectors at both ends. When plugging the connector into the port, make sure the slider guide is positioned to the right side so that it fits snugly into the port.

The 100 Mbps fiber ports are switched ports, and perform as a domain, providing a high bandwidth backbone connection that supports long fiber cable distances (up to 5 km for multi-mode, and 40 km for single-mode) for installation versatility.

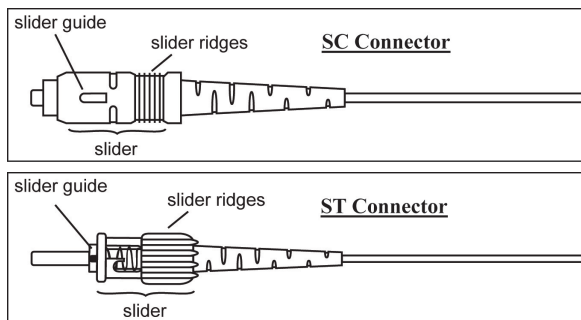

Switching, Filtering, and Forwarding

Each time a packet arrives at one of the switched ports, a decision is made to either filter or forward the packet. Packets with source and destination addresses belonging to the same port segment will be filtered, constraining those packets to one port, and relieving the rest of the network from the need to process them. A packet with destination address on another port segment will be forwarded to the appropriate port, and will not be sent to the other ports where it is not needed. Packets that are used in maintaining the operation of the network (such as the occasional multi-cast packet) are forwarded to all ports. EDS operates in the store-and-forward switching mode, which eliminates bad packets and enables peak performance to be achieved when there is heavy traffic on the network.

Switching and Address Learning

Moxa EDS has an address table that can hold up to 8K node addresses, which makes it suitable for use with large networks. The address tables are self-learning, so that as nodes are added or removed, or moved from one segment to another, EDS automatically keeps up with new node locations. An address-aging algorithm causes the least-used addresses to be deleted in favor of newer, more frequently used addresses. To reset the address buffer, power down the unit and then power it back up.

Auto-Negotiation and Speed Sensing

The EDS's RJ45 Ethernet ports independently support auto-negotiation for transmission speeds of 10 Mbps and 100 Mbps with operation according to the IEEE802.3 standard. This means that some nodes could be operating at 10 Mbps, while at the same time, other nodes are operating at 100 Mbps.

Auto-negotiation takes place when an RJ45 cable connection is made, and then each time a LINK is enabled. The EDS advertises its capability for using 10 Mbps and 100 Mbps transmission speeds, with the device at the other end of the cable expected to advertise similarly.

Depending on what type of device is connected, this will result in agreement to operate at a speed of 10 Mbps, 100 Mbps.

If an EDS's RJ45 Ethernet port is connected to a non-negotiating device, it will default to 10 Mbps speed and half-duplex mode, as required by the IEEE802.3 standard.

Specifications

Technology	
Standards	IEEE 802.3 for 10BaseT, IEEE 802.3u for 100BaseT(X) and 100Base FX, IEEE 802.1p for Class of Service
Flow Control	IEEE 802.3x flow control, back pressure flow control
Interface	
RJ45 Ports	10/100BaseT(X) auto negotiation speed
Fiber Ports	100BaseFX ports (SC/ST connector)
LED Indicators	PWR1, PWR2, Fault, 10/100M, 100M
DIP Switch	Port break alarm, QoS, BSP
Alarm Contact	One relay output with current carrying capacity of 1A @ 24 VDC

Optical Fiber

		100Base FX			
		Multi-mode	Single-mode 40 km	Single-mode 80 km	
Fiber Cable Type	OM1	50/125 μm	G.652	G.652	
		800 MHz*Km			
Typical Distance		4 km	5 km	40 km	80 km
Wavelength	Typical (nm)	1300		1310	1550
	TX Range (nm)	1260 to 1360		1280 to 1340	1530 to 1570
	RX Range (nm)	1100 to 1600		1100 to 1600	1100 to 1600
Optical Power	TX Range (dBm)	-10 to -20		0 to -5	0 to -5
	RX Range (dBm)	-3 to -32		-3 to -34	-3 to -34
	Link Budget (dB)	12		29	29
	Dispersion Penalty (dB)	3		1	1

Note: When connecting 40 km or 80 km single-mode fiber over a short distance, we recommend putting an attenuator to prevent the transceiver from being damaged by excessive optical power.

Typical Distance: To reach the typical distance of a specified fiber transceiver, please refer to the following formula: Link budget(dB) > dispersion penalty(dB) + total link loss(dB).

Switch Properties

MAC Table Size	8 K
Packet Buffer Size	2 Mbits
Processing Type	Store and Forward

Power

Input Voltage	12/24/48 VDC redundant dual inputs
Input Current	EDS-2016-ML: 0.171 A (max.) EDS-2016-ML-MM-SC: 0.291 A (max.) EDS-2016-ML-MM-ST: 0.303 A (max.) EDS-2016-ML-SS-SC: 0.325 A (max.) Relay output: 24 VDC, 1 A, Resistance
Connection	Removable 6-contact terminal block 28-14 AWG, 1.7 lb-in All wires must be able to withstand at least 85°C
Overload Current Protection	Present
Reverse Polarity Protection	Present

Mechanical

Casing	IP30 protection, metal case
Dimensions (W x H x D)	EDS-2016-ML Copper model: 36 x 135 x 95 mm (1.41 x 5.31 x 3.74 in) EDS-2016-ML Fiber model: 58 x 135 x 95 mm (2.28 x 5.31 x 3.74 in)

Weight	EDS-2016-ML Copper model: 486 g (1.07 lb) EDS-2016-ML Fiber model: 648 g (1.43 lb)
Installation	DIN-rail, Wall Mounting (optional kit)
Environmental Limits	
Operating Temperature	-10 to 60°C (32 to 140°F) -40 to 75°C (-40 to 167°F) for -T models
Storage Temperature	-40 to 85°C (-40 to 185°F)
Ambient Relative Humidity	5 to 95% (non-condensing)
Altitude	Up to 2,000 m
Note	This device must be installed within a suitable, final enclosure
Regulatory Approvals	
Note: Only for indoor use.	
Safety	UL 61010-2-201, EN 62368-1(LVD)
EMI	FCC Part 15, CISPR (EN55032) class A
EMS	EN61000-4-2 (ESD), Level 3 EN61000-4-3 (RS), Level 3 EN61000-4-4 (EFT), Level 3 EN61000-4-5 (Surge), Level 3 EN61000-4-6 (CS), Level 3 EN61000-4-8
Hazardous Location*	UL/cUL Class I, Division 2, Groups A, B, C, and D; ATEX Zone 2, Ex nA nC IIC T4 Gc
Rail Traffic	EN 50121-4
Shock	IEC60068-2-27
Free Fall	IEC60068-2-32
Vibration	IEC60068-2-6
Warranty	
Warranty Period	5 years
Details	See www.moxa.com/warranty

NOTE Please check Moxa's website for the latest certification status.