

MGate MB3000 Modbus Gateway User Manual

Version 13.0, September 2022

www.moxa.com/products



© 2022 Moxa Inc. All rights reserved.

MGate MB3000 Modbus Gateway User Manual

The software described in this manual is furnished under a license agreement and may be used only in accordance with the terms of that agreement.

Copyright Notice

© 2022 Moxa Inc. All rights reserved.

Trademarks

The MOXA logo is a registered trademark of Moxa Inc.
All other trademarks or registered marks in this manual belong to their respective manufacturers.

Disclaimer

- Information in this document is subject to change without notice and does not represent a commitment on the part of Moxa.
- Moxa provides this document as is, without warranty of any kind, either expressed or implied, including, but not limited to, its particular purpose. Moxa reserves the right to make improvements and/or changes to this manual, or to the products and/or the programs described in this manual, at any time.
- Information provided in this manual is intended to be accurate and reliable. However, Moxa assumes no responsibility for its use, or for any infringements on the rights of third parties that may result from its use.
- This product might include unintentional technical or typographical errors. Changes are periodically made to the information herein to correct such errors, and these changes are incorporated into new editions of the publication.

Technical Support Contact Information

www.moxa.com/support

Table of Contents

1. Introduction	5
Overview	5
Package Checklist	6
Product Features	6
2. Getting Started	7
Connecting Power	7
Connecting Serial Devices	7
RS-485 Termination and Pull High/Low Resistors	8
Connecting to a Host or the Network	8
Installing the Software	8
Mounting the Unit	8
3. Hardware: MB3180	9
Panel Layout	9
LED Indicators	10
Dimensions	10
Jumpers	11
DIN-Rail and Wall Mounting	12
Specifications	12
4. Hardware: MB3280	14
Panel Layout	14
LED Indicators	15
Dimensions	15
Jumpers	16
DIN-Rail and Wall Mounting	17
Specifications	17
5. Hardware: MB3480	19
Panel Layout	19
LED Indicators	20
Dimensions	20
Jumpers	21
DIN-Rail and Wall Mounting	22
Specifications	22
6. Hardware: MB3170, MB3170I	24
Panel Layout	24
LED Indicators	24
Dimensions	25
Jumpers	26
DIN-Rail and Wall Mounting	27
Specifications	28
7. Hardware: MB3270, MB3270I	30
Panel Layout	30
LED Indicators	30
Dimensions	31
Jumpers	32
DIN-Rail and Wall Mounting	33
Specifications	33
8. Pin Assignments	35
DB9 (Male)	35
Terminal Block (RS-422, RS-485)	35
Power Input, Relay Output	35
9. Typical Applications	36
Ethernet Masters with Multiple Serial Slaves	36
Serial Masters with Multiple Ethernet Slaves	36
Modbus TCP Clients with ASCII and RTU Slaves	37
Serial Master with Serial Slaves over Internet	37
10. Configuring the Modbus Gateway	38
Installing the Software	38
Starting MGate Manager	42

Change Language Setting.....	42
Connecting to the Unit.....	43
Broadcast Search	44
Specify IP Address.....	45
Modifying the Configuration	47
Password Protection.....	47
Basic Settings	48
Network Settings.....	49
Serial Settings	50
Protocol Settings	51
System Settings.....	59
Verifying the Location of the Unit.....	67
Monitoring Modbus Activity	67
ProCOM Mapping	72
Upgrading Firmware.....	75
Load Default	77
Export/Import	78
MXview	80
MXconfig	82
11. Case Studies	83
Introduction.....	83
Replace Serial Masters with Ethernet Master(s), Slave IDs are Configurable	83
Replace Serial Masters with Ethernet Master(s), Slave IDs are Fixed	84
Keep Serial Master and Add Ethernet Master(s)	84
Serial Redirector.....	85
Integrate Modbus RTU, ASCII, and TCP at the Same Time	85
A. Modbus Overview	86
Introduction.....	86
Devices are Either Masters or Slaves.....	86
Slaves are Identified by ID.....	86
Communication is by Request and Response	86
Requests Need a Time Limit.....	87
Modbus Ethernet vs. Modbus Serial.....	88
Integrate Modbus Serial and Ethernet with Gateways.....	88
B. SNMP Agents with MIB II and RS-232-Like Groups	89
RFC1213 MIB-II Supported SNMP Variables	89
RFC1317 RS-232-Like Groups	90

1. Introduction

Welcome to the MGate MB3000 line of Modbus gateways. All models feature easy integration of Modbus TCP to Modbus RTU/ASCII and feature RS-232/422/485 ports for Modbus serial communication. One, two, and four-port models are available.

This user's manual applies to the following models:

- MGate MB3180
- MGate MB3280
- MGate MB3480
- MGate MB3170/3170I
- MGate MB3270/3270I

Overview

The MGate MB3000 is a line of Modbus protocol gateways that provides users with

- seamless integration of Ethernet and serial Modbus devices
- powerful operation modes to handle almost any Modbus application
- Windows utilities for easy setup and traffic monitoring

Seamless integration of Ethernet and serial Modbus devices

Modbus is one of the most popular automation protocols in the world, supporting traditional RS-232/422/485 devices and recently developed Ethernet devices. Many industrial devices, such as PLCs, DCSs, HMIs, instruments, and meters, use Modbus as their communication standard. However, the Ethernet-based Modbus protocol is so different from the original serial-based protocols that a communication gateway is needed as a bridge for integration.

In order to integrate Modbus networks, the MGate MB3000 includes an Ethernet port and up to four serial ports that support RS-232, RS-422, and RS-485 communication. It automatically and intelligently translates between Modbus TCP (Ethernet) and Modbus ASCII/RTU (serial) protocols, allowing Ethernet-based PLCs to control instruments over RS-485 without additional programming or effort.

Powerful operation modes to handle almost any Modbus application

With the Modbus protocol, devices must be clearly defined as either masters or slaves. Unlike other Modbus gateways, the MGate MB3000's operation modes allow users to select master or slave operation for each serial port. Not only does the MB3000 allow Ethernet masters to control serial slaves, it also allows serial masters to control Ethernet slaves. In addition, the advanced models (the MGate MB3170 and MB3270 Series) allow both Ethernet and serial slaves to be controlled by both Ethernet and serial masters. On multiport models, each serial port's operation mode is independent of the other ports, so that one port may be configured for slave mode and another port configured for master mode.

Extra address mapping and exception parameters are provided to ensure that most situations can be handled.

Web console and Windows utilities for easy setup and traffic monitoring

A Windows utility is provided to make configuration and operation of the MGate MB3000 as easy as possible. The utility automatically connects to all available MGate MB3000 units on the LAN for you. Traffic monitoring functions help you troubleshoot Modbus communication problems by tracking items such as connection status and address translation errors. All series provide a web console for configuration.

Package Checklist

All models in the MGate MB3000 line are shipped with the following items:

Standard Accessories

- 1 MGate MB3000 Modbus gateway
- Quick installation guide (printed)
- Power adapter (MB3180, MB3280, and MB3480 only)
- Warranty card

Optional Accessories

- DK-35A: DIN-rail mounting kit (35 mm)
- Mini DB9F-to-TB Adaptor: DB9 female to terminal block adapter
- DR-4524: 45W/2A DIN-rail 24 VDC power supply with universal 85 to 264 VAC input
- DR-75-24: 75W/3.2A DIN-rail 24 VDC power supply with universal 85 to 264 VAC input
- DR-120-24: 120W/5A DIN-rail 24 VDC power supply with 88 to 132 VAC/176 to 264 VAC input by switch



NOTE

Notify your sales representative if any of the above items is missing or damaged.

Product Features

- Integration of Modbus TCP and Modbus RTU/ASCII networks
- Auto device routing (patented)
- Up to 31 Modbus RTU/ASCII slaves per serial port
- Allow access to up to 16 (MB3180/MB3280/MB3480) or 32 (MB3170/MB3270) TCP master/client devices, connect up to 32 TCP slave/server devices
- Configuration over Ethernet with easy-to-use Windows utility
- 10/100M Fast Ethernet with automatic IP setting (DHCP)
- Software-selectable RS-232/485/422 communication
- High-speed serial interface supporting 921.6 Kbps
- Serial port routing by IP address, TCP port, or ID mapping
- Extend transmission distance up to 4 km / 20 km through multimode/single-mode fiber models.
- ProCOM: Virtual Serial Port for flexible Modbus to Modbus TCP communication (for MB3170/MB3170I/MB3270/MB3270I)
- Supports MXview utility
- Supports SNMP v1, v2c, and v3.

2. Getting Started

This chapter provides basic instructions for installing the MGate MB3000.

Connecting Power

The unit can be powered using the AC adaptor or by connecting a power source to the terminal block, depending on the model. The following instructions are for the AC adaptor:

1. Plug the connector of the power adapter into the DC-IN jack on the back of the unit.
2. Plug the power adapter into an electrical outlet.
3. Follow these instructions to connect a power source to the terminal block:
4. Loosen or remove the screws on the terminal block.
5. Connect the 12~48 VDC power line to the terminal block.
6. Tighten the connections using the screws on the terminal block.

Note that the unit does not have an on/off switch. It automatically turns on when it receives power. The PWR LED on the top panel will glow to indicate that the unit is receiving power.

For power terminal block pin assignments, please refer to the hardware reference chapter for your model.

Connecting Serial Devices

The unit's serial port(s) are located on the back panel. There are two options for connecting serial devices, depending on the serial interface:

- You may use a DB9-to-DB9 cable to connect a serial device to the unit. Plug one end of the cable into the port on the unit's back panel and plug the other end of the cable into the device's serial port.
- You may make your own customized serial cable to connect a serial device to the unit. For the pin assignments of the unit's serial port, please refer to Chapter 10. This information can then be used to construct your own serial cable.

If you are connecting a RS-485 multidrop network with multiple devices, please note the following:

- All devices that are connected to a single serial port must use the same protocol (i.e., either Modbus RTU or Modbus ASCII).
- Each master device must get its own port on the unit. If you are connecting a network with both master and slave devices, the master must be connected to a separate port from the slaves. Furthermore, the master will only be able to communicate to Modbus TCP servers, not to the ASCII or RTU slaves that are connected to a different serial port.

For serial port pin assignments, please refer to the hardware reference chapter for your model.

RS-485 Termination and Pull High/Low Resistors

In some critical RS-485 environments, you may need to add termination resistors to prevent the reflection of serial signals. When using termination resistors, it is important to set the pull high/low resistors correctly so that the electrical signal is not corrupted. For each serial port, DIP switches or jumper settings are used to set the pull high/low resistor values. For all models except the MB3180, a built-in 120 Ω termination resistor can also be enabled.

To modify the termination and pull high/low resistor settings, please refer to the hardware reference chapter for your model.



ATTENTION

Do not use the 1 K Ω pull high/low setting on the MGate MB3000 when using the RS-232 interface. Doing so will degrade the RS-232 signals and reduce the effective communication distance.

Connecting to a Host or the Network

A 10/100BaseT Ethernet port is located on the unit's front panel. This port is used for the unit's connection to a host or Ethernet network, as follows:

- For normal operation, use a standard straight-through Ethernet cable to connect the unit to your Modbus TCP network.
- For initial configuration or for troubleshooting purposes, you may connect the unit directly to a PC. In this case, use a crossover Ethernet cable to connect the unit to your PC's Ethernet connector.

The unit's Link LED will light up to indicate a live Ethernet connection.

For advanced models (MB 3170, MB3170I, MB3270, and MB3270I), two Ethernet ports are provided. One port can be used to connect to the network, and the other port can be used to connect to another Ethernet device.

Installing the Software

The Windows management utility is available for download. Please download it from Moxa's website at <http://www.moxa.com>. For additional details, please refer to Chapter 9.

Mounting the Unit

The unit can be placed on a desktop, mounted on the wall, or mounted on a DIN-rail. The MB3180, MB3280, and MB3480 require optional attachments for DIN-rail mounting. For additional details, please refer to the hardware reference chapter for your model.

3. Hardware: MB3180

This chapter provides hardware information for the MGate MB3180.

Panel Layout

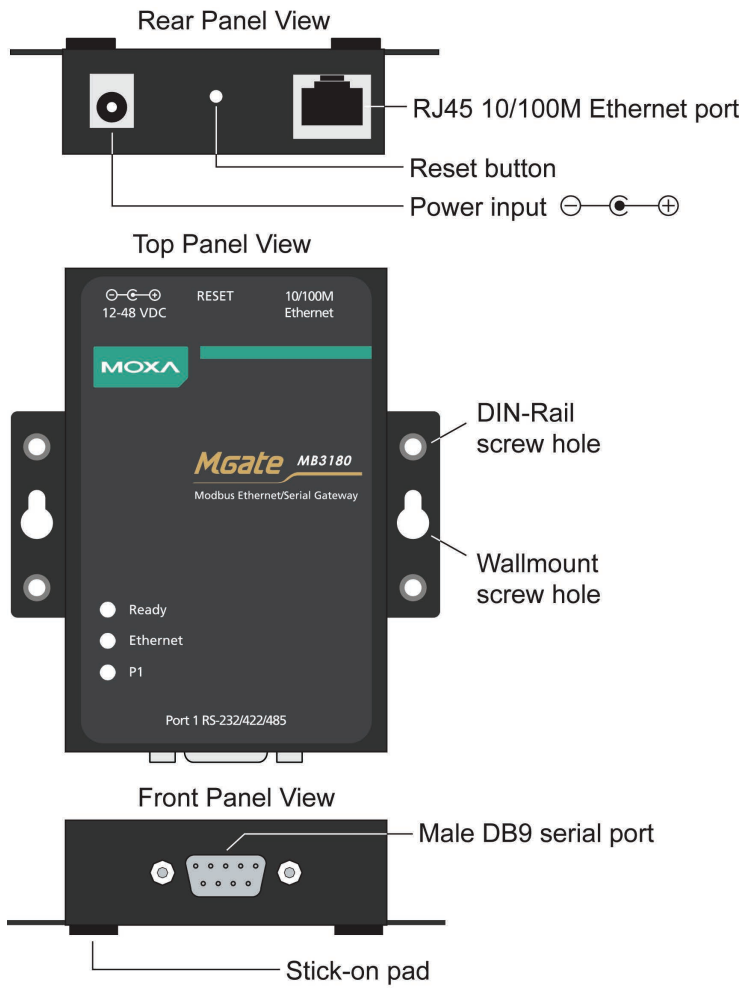

LED Indicators

Name	Color	Function
Ready	Red	Steady on: Power is on and unit is booting up. Blinking: Indicates an IP conflict, or the DHCP or BOOTP server is not responding properly.
	Green	Steady on: Power is on and unit is functioning normally. Blinking: Unit is responding to software Locate function.
	Off	Power is off, or power error condition exists.
Ethernet	Amber	10 Mbps Ethernet connection.
	Green	100 Mbps Ethernet connection.
	Off	Ethernet cable is disconnected, or has a short.
P1	Amber	Serial port is receiving data.
	Green	Serial port is transmitting data.
	Off	No data is being transmitted or received through the serial port.

Dimensions

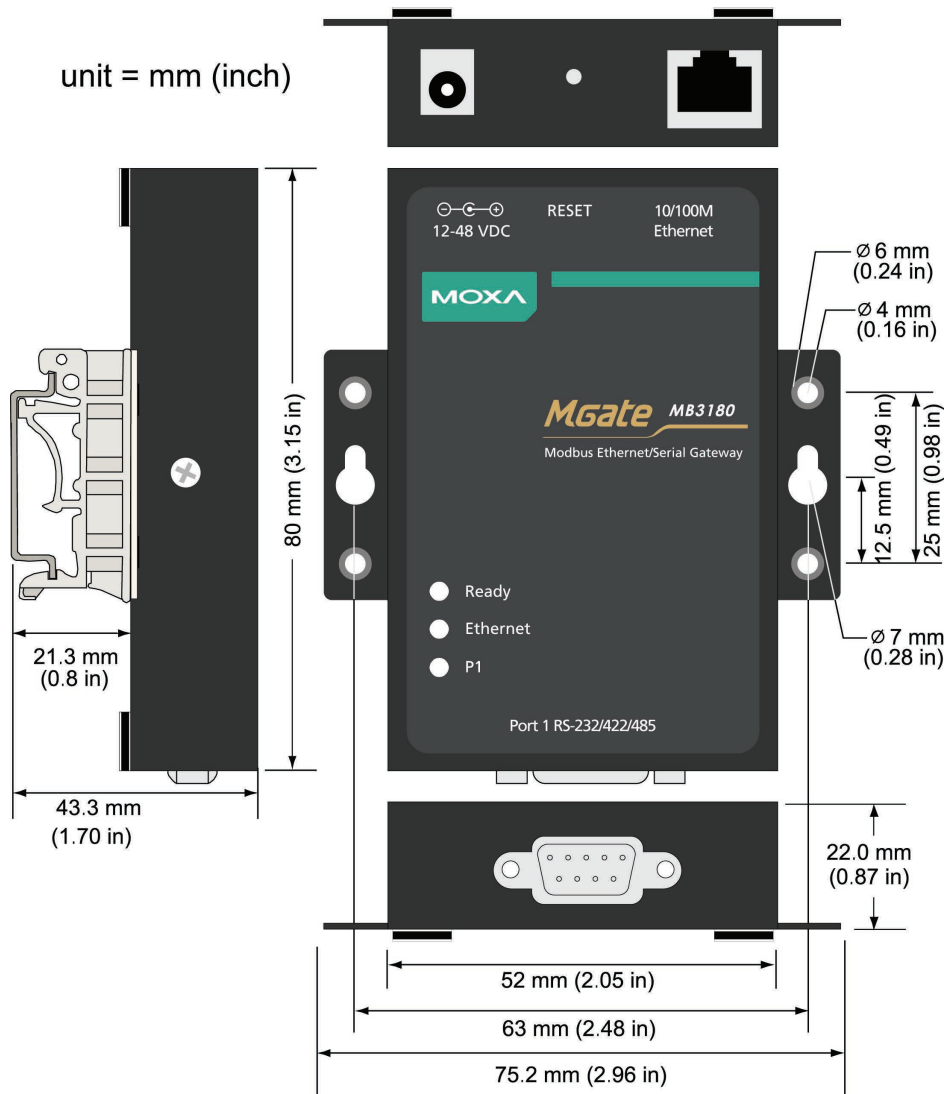

Jumpers

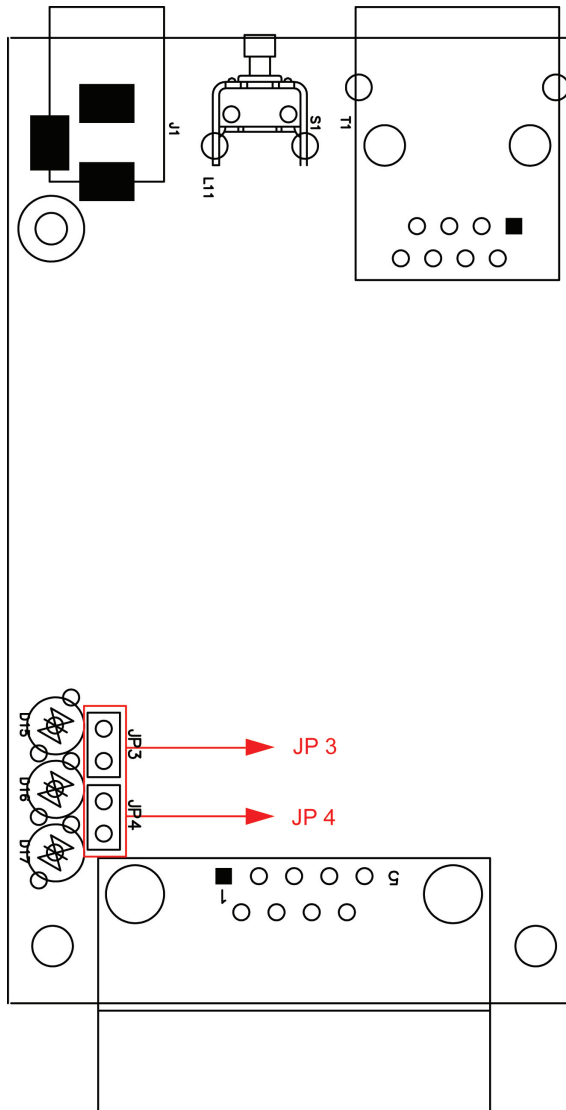

To set the pull high/low resistors to 150 K Ω , leave jumpers **JP3** and **JP4** open (not shorted). This is the default setting.

To set the pull high/low resistors to 1 K Ω , short jumpers **JP3** and **JP4** with jumper caps.



ATTENTION

Do not use the 1 K Ω pull high/low setting on the MGate MB3000 when using the RS-232 interface. Doing so will degrade the RS-232 signals and reduce the effective communication distance.

DIN-Rail and Wall Mounting

Mounting on a DIN-rail: Attach the DIN-rail accessories and latch the unit onto the DIN-rail as shown. The DIN-rail kit is ordered separately.

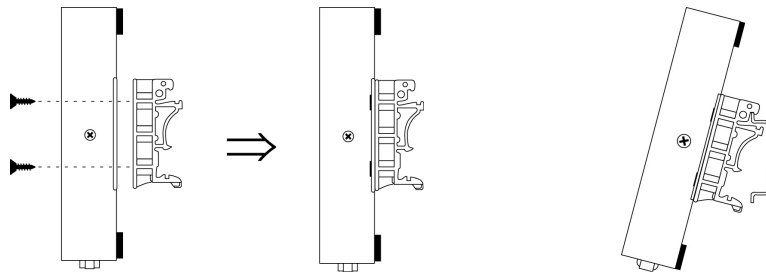

Mounting on the wall: Place two screws in the wall and slide the unit onto the screws as shown. The head of the screws should be 5 to 7 mm in diameter, the shaft should be 3 to 4 mm in diameter, and the length of the screws should be at least 10.5 mm. Make sure to leave about 2 mm of space between the head and the wall.

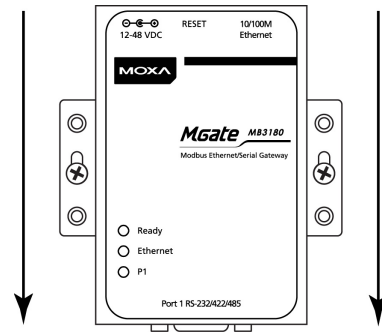
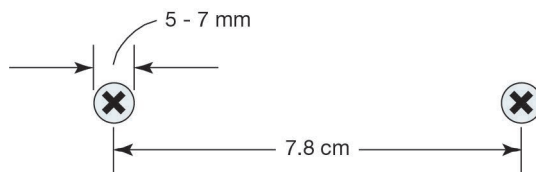
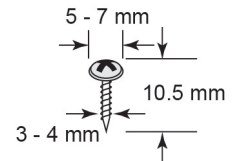

Specifications

LAN	
Ethernet	10/100 Mbps, RJ45, Auto MDI/MDIX
Protection	Built-in 1.5 kV magnetic isolation
Serial Interface	
Interface	RS-232/422/485
No. of Ports	1 port
Connector Type	DB9 (male)
Signals	RS-232: TxD, RxD, RTS, CTS, DTR, DSR, DCD, GND RS-422: Tx+, Tx-, Rx+, Rx-, GND RS-485 (2-wire): Data+, Data-, GND RS-485 (4-wire): Tx+, Tx-, Rx+, Rx-, GND
Serial Line Protection	15 kV ESD for all signals
RS-485 Data Direction	Patented ADDC™
Serial Communication Parameters	
Parity	None, Even, Odd, Space, Mark
Data Bits	7, 8
Stop Bits	1, 2
Flow Control	RTS/CTS
Transmission Speed	50 bps to 921.6 Kbps
Software Features	
Operation Mode	RTU Slave, RTU Master, ASCII Slave, ASCII Master
Utilities	MGate Manager
Multi-Masters and Multi-Request	16 simultaneous TCP masters, 32 simultaneous requests for each TCP master

Power Requirements

Power Input	12 to 48 VDC
Power Connector	Power jack
Power Consumption	200 mA @ 12 VDC, 60 mA @ 48 VDC

Environmental Limits

Operating Temperature	0 to 60°C (32 to 140°F)
Storage Temperature	-40 to 85°C (-40 to 185°F)
Ambient Relative Humidity	5 to 95% (non-condensing)
Altitude	Up to 2000 m (795 hPa); higher altitudes on demand

Note: Please contact Moxa if you require products guaranteed to function properly at higher altitudes.

Standards and Certifications

Safety	UL 60950-1, EN 60950-1
EMC	CE, FCC
EMI	EN 55032 Class A, FCC Part 15 Subpart B Class A
EMS	EN 55024, EN 61000-4-2 (ESD) Level 2, EN 61000-4-3 (RS) Level 2, EN 61000-4-4 (EFT) Level 2, EN 61000-4-5 (Surge) Level 2, EN 61000-4-6 (CS) Level 2, EN 61000-4-8 (PFMF) Level 1, EN 61000-4-11

Reliability

MTBF (mean time between failures)	MGate M3180: 908,440 hrs
-----------------------------------	--------------------------

Warranty

Period	5 years
--------	---------

4. Hardware: MB3280

This chapter provides hardware information for the MGate MB3280.

Panel Layout

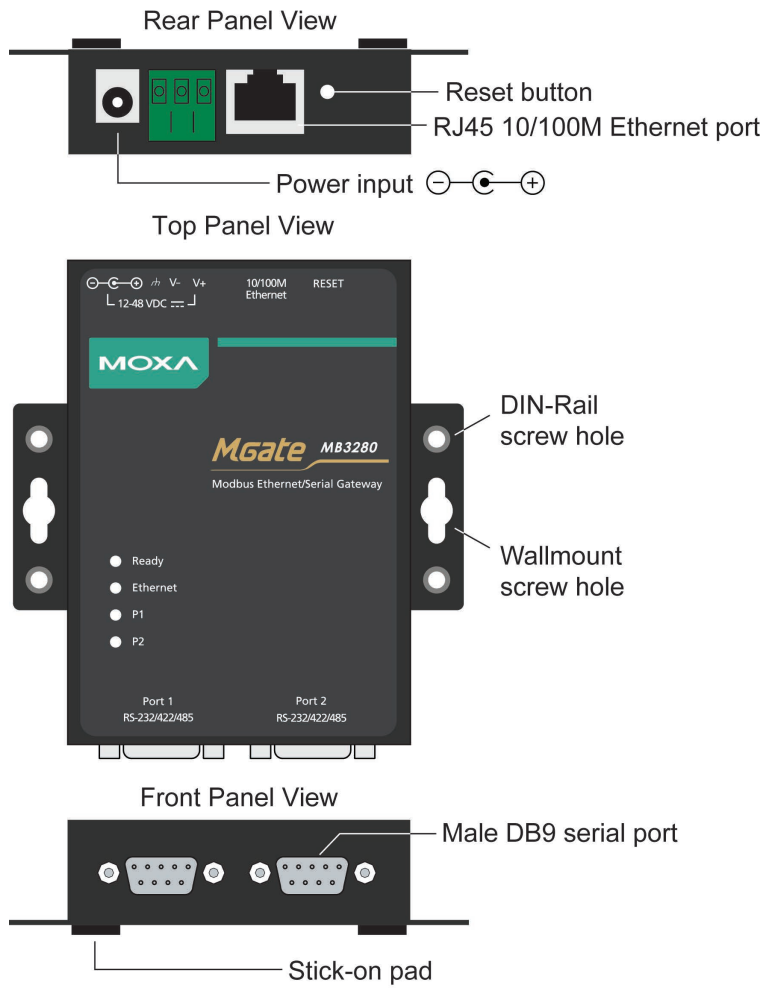

LED Indicators

Name	Color	Function
Ready	Red	Steady on: Power is on and unit is booting up. Blinking: Indicates an IP conflict, or the DHCP or BOOTP server is not responding properly.
	Green	Steady on: Power is on and unit is functioning normally. Blinking: Unit is responding to software Locate function.
	Off	Power is off, or power error condition exists.
Ethernet	Amber	10 Mbps Ethernet connection.
	Green	100 Mbps Ethernet connection.
	Off	Ethernet cable is disconnected, or has a short.
P1/P2	Amber	Serial port is receiving data.
	Green	Serial port is transmitting data.
	Off	No data is being transmitted or received through the serial port.

Dimensions

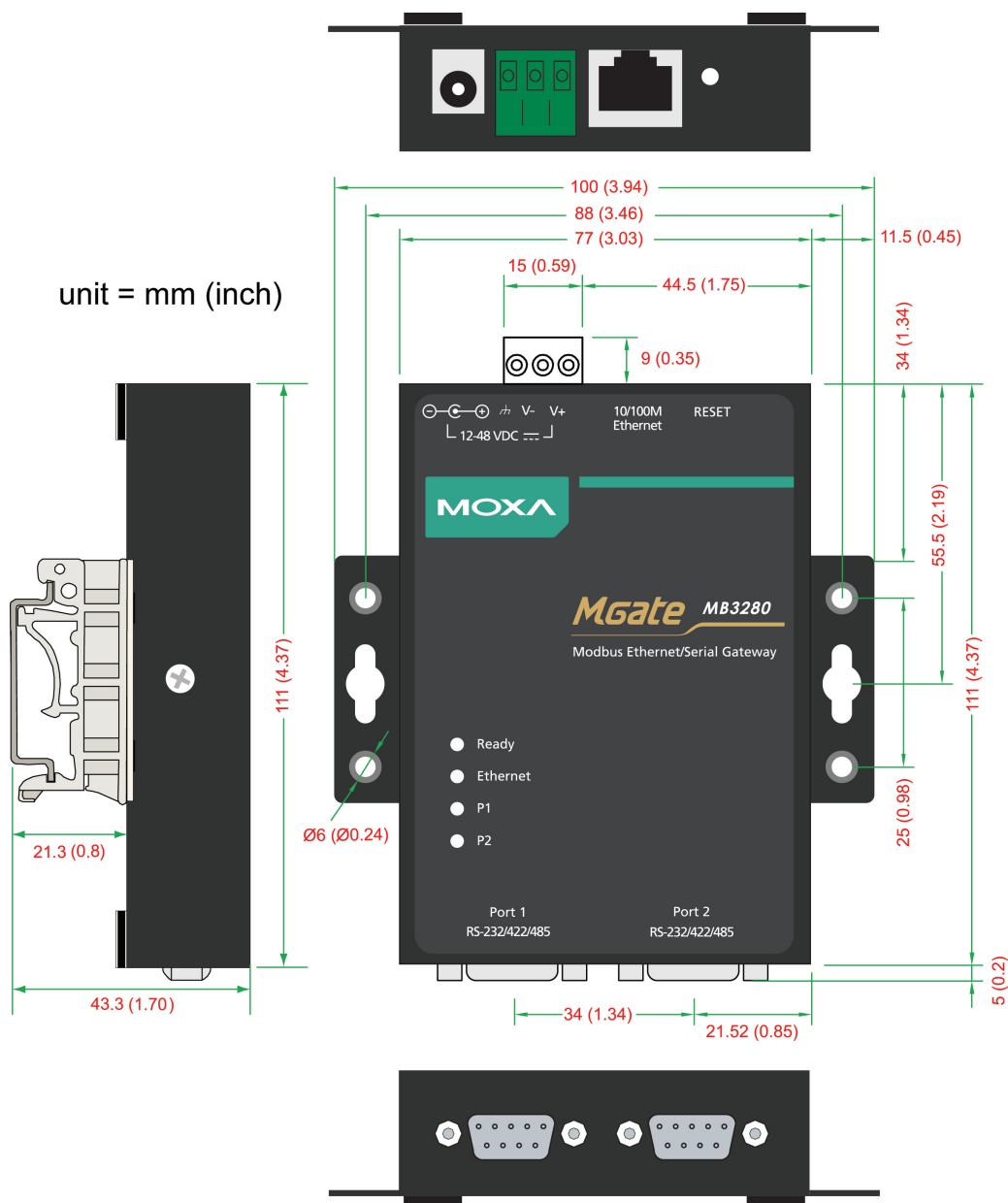

Jumpers

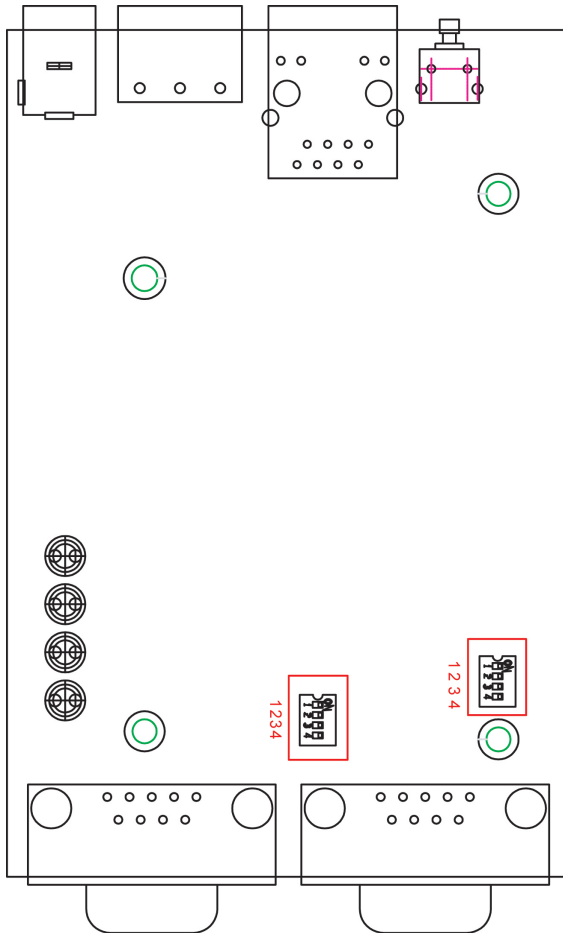

To add a 120 Ω termination resistor, set switch 3 on the port's assigned DIP switch to ON; set switch 3 to OFF (the default setting) to disable the termination resistor.

To set the pull high/low resistors to 150 K Ω , set switches 1 and 2 on the port's assigned DIP switch to OFF. This is the default setting.

To set the pull high/low resistors to 1 K Ω , set switches 1 and 2 on the port's assigned DIP switch to ON.

Switch 4 on the port's assigned DIP switch is reserved.



ATTENTION

Do not use the 1 K Ω pull high/low setting on the MGate MB3000 when using the RS-232 interface. Doing so will degrade the RS-232 signals and reduce the effective communication distance.

DIN-Rail and Wall Mounting

Mounting on a DIN-rail: Attach the DIN-rail accessories and latch the unit onto the DIN-rail as shown. The DIN-rail kit is ordered separately.

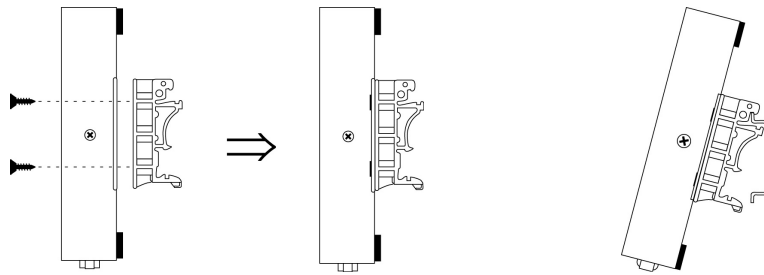

Mounting on the wall: Place two screws in the wall and slide the unit onto the screws as shown. The head of the screws should be 5 to 7 mm in diameter, the shaft should be 3 to 4 mm in diameter, and the length of the screws should be at least 10.5 mm. Make sure to leave about 2 mm of space between the head and the wall.

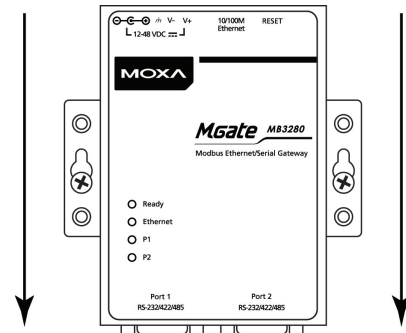
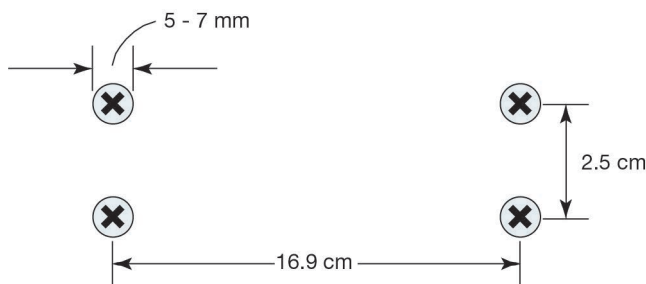
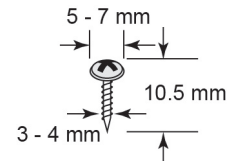

Specifications

LAN

Ethernet 10/100 Mbps, RJ45, Auto MDI/MDIX
Protection Built-in 1.5 kV magnetic isolation

Serial Interface

Interface RS-232/422/485
No. of Ports 2 ports
Connector Type DB9 (male)
Signals
RS-232: TxD, RxD, RTS, CTS, DTR, DSR, DCD, GND
RS-422: Tx+, Tx-, Rx+, Rx-, GND
RS-485 (2-wire): Data+, Data-, GND
RS-485 (4-wire): Tx+, Tx-, Rx+, Rx-, GND

Serial Line Protection 15 kV ESD for all signals
RS-485 Data Direction Patented ADDC™

Serial Communication Parameters

Parity None, Even, Odd, Space, Mark
Data Bits 7, 8
Stop Bits 1, 2
Flow Control RTS/CTS
Transmission Speed 50 bps to 921.6 Kbps

Software Features

Operation Mode RTU Slave, RTU Master, ASCII Slave, ASCII Master
Utilities MGate Manager
Multi-Masters and Multi-Request 16 simultaneous TCP masters, 32 simultaneous requests for each TCP master

Power Requirements

Power Input	12 to 48 VDC
Power Connector	Power jack and terminal block
Power Consumption	250 mA @ 12 VDC, 90 mA @ 48 VDC

Environmental Limits

Operating Temperature	0 to 60°C (32 to 140°F)
Storage Temperature	-40 to 85°C (-40 to 185°F)
Ambient Relative Humidity	5 to 95% (non-condensing)
Altitude	Up to 2000 m (795 hPa); higher altitudes on demand

Note: Please contact Moxa if you require products guaranteed to function properly at higher altitudes.

Standards and Certifications

Safety	UL 60950-1, IEC 60950-1, UL 62368-1, IEC 62368-1
EMC	CE, FCC
EMI	EN 55032 Class A, FCC Part 15 Subpart B Class A
EMS	EN 55024, EN 61000-4-2 (ESD) Level 2, EN 61000-4-3 (RS) Level 2, EN 61000-4-4 (EFT) Level 2, EN 61000-4-5 (Surge) Level 2, EN 61000-4-6 (CS) Level 2, EN 61000-4-8 (PFMF) Level 1, EN 61000-4-11

Reliability

MTBF (mean time between failures)	MGate M3280: 749,455 hrs
-----------------------------------	--------------------------

Warranty

Period	5 years
--------	---------

5. Hardware: MB3480

This chapter provides hardware information for the MGate MB3480.

Panel Layout

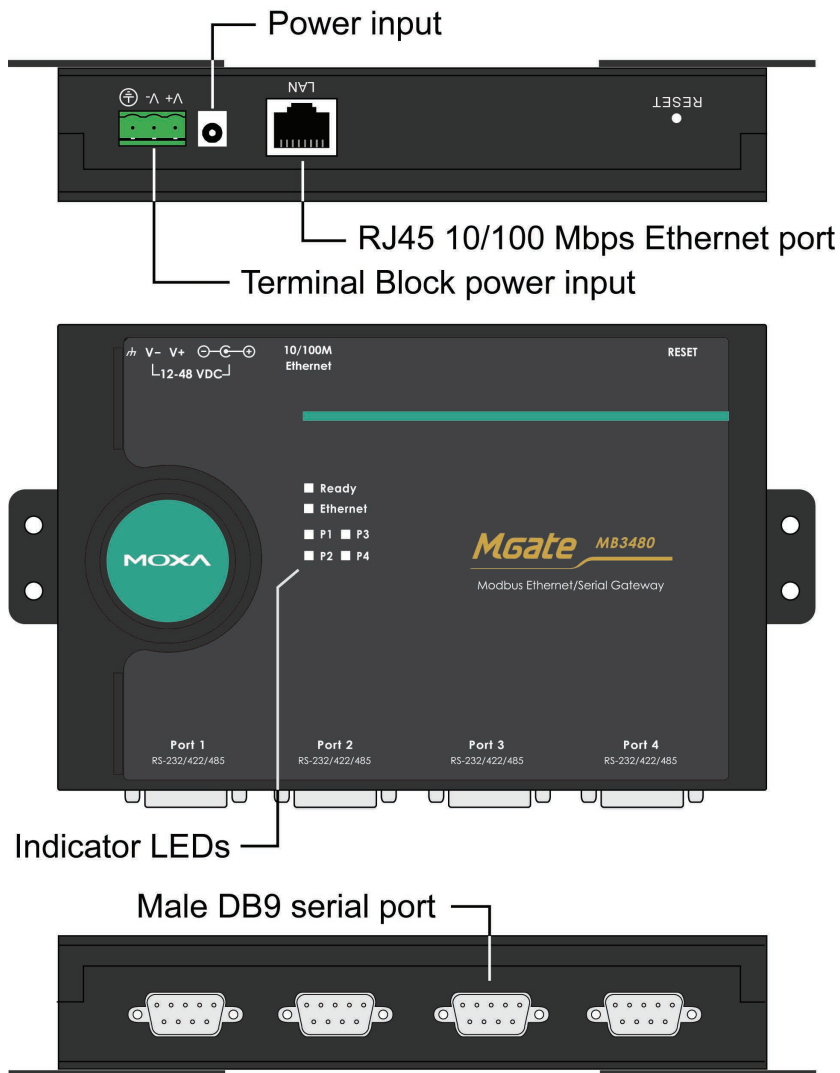

LED Indicators

Name	Color	Function
Ready	Red	Steady on: Power is on and unit is booting up. Blinking: Indicates an IP conflict, or the DHCP or BOOTP server is not responding properly.
	Green	Steady on: Power is on and unit is functioning normally. Blinking: Unit is responding to software Locate function.
	Off	Power is off, or power error condition exists.
Ethernet	Amber	10 Mbps Ethernet connection.
	Green	100 Mbps Ethernet connection.
	Off	Ethernet cable is disconnected, or has a short.
P1, P2, P3, P4	Amber	Serial port is receiving data.
	Green	Serial port is transmitting data.
	Off	No data is being transmitted or received through the serial port.

Dimensions

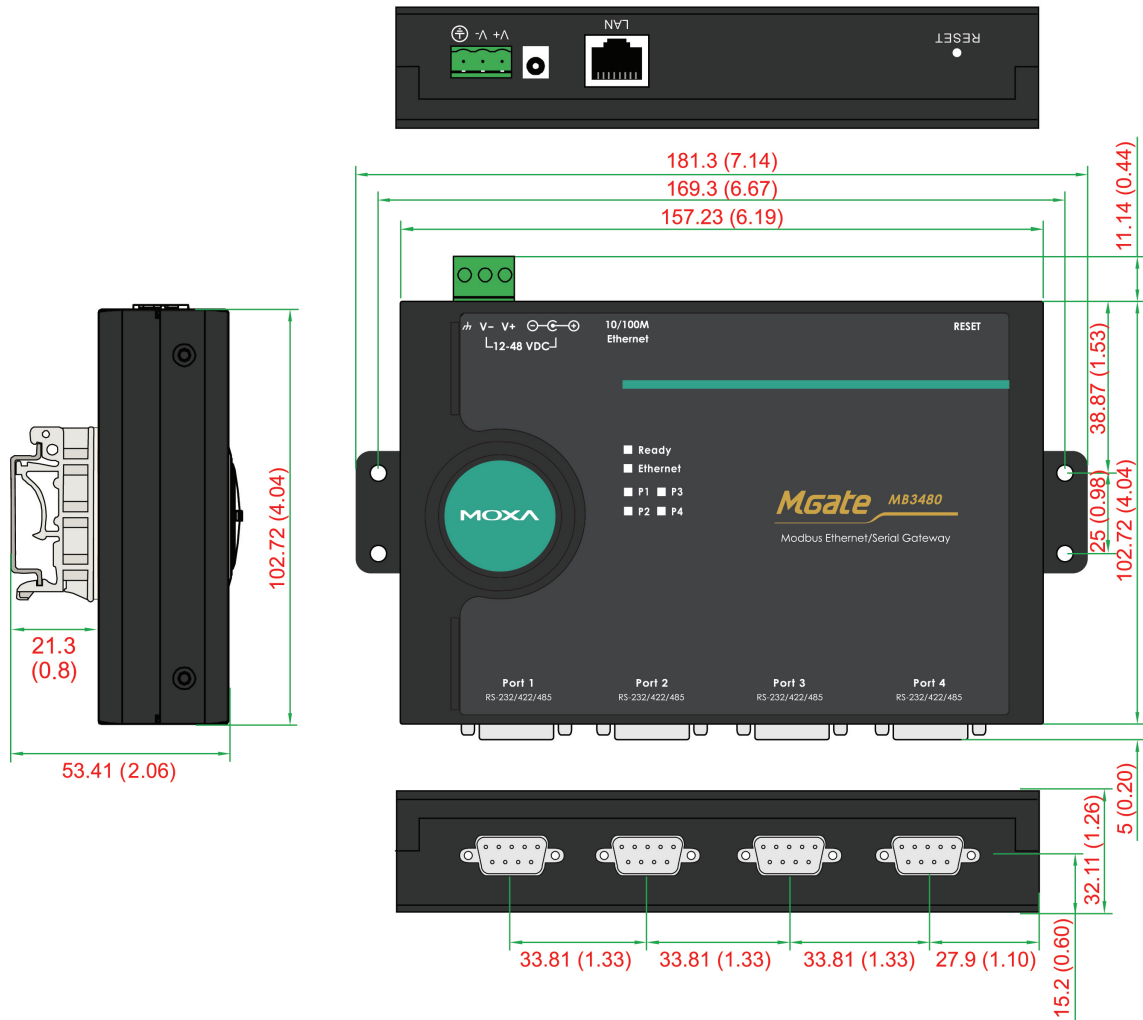

Jumpers

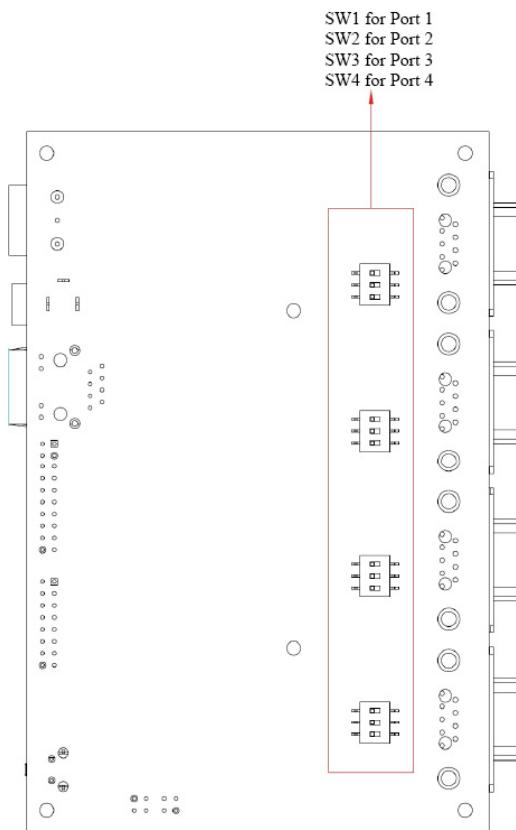

To add a 120 Ω termination resistor, set switch 3 on the port's assigned DIP switch to ON; set switch 3 to OFF (the default setting) to disable the termination resistor.

To set the pull high/low resistors to 150 K Ω , set switches 1 and 2 on the port's assigned DIP switch to OFF. This is the default setting.

To set the pull high/low resistors to 1 K Ω , set switches 1 and 2 on the port's assigned DIP switch to ON.



ATTENTION

Do not use the 1 K Ω pull high/low setting on the MGate MB3000 when using the RS-232 interface. Doing so will degrade the RS-232 signals and reduce the effective communication distance.

DIN-Rail and Wall Mounting

Mounting on a DIN-rail: Attach the DIN-rail accessories and latch the unit onto the DIN-rail as shown. The DIN-rail kit is ordered separately.

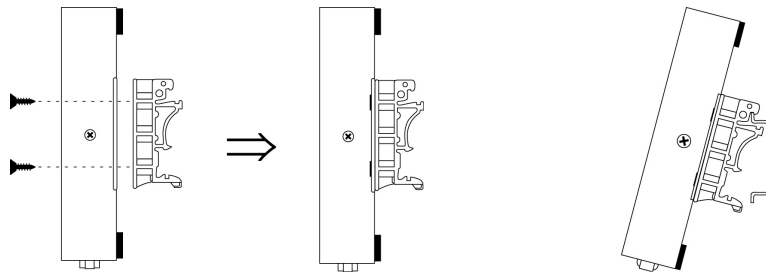

Mounting on the wall: You will first need to attach the mounting plates to the unit. Place four screws in the wall and slide the unit onto the screws as shown.

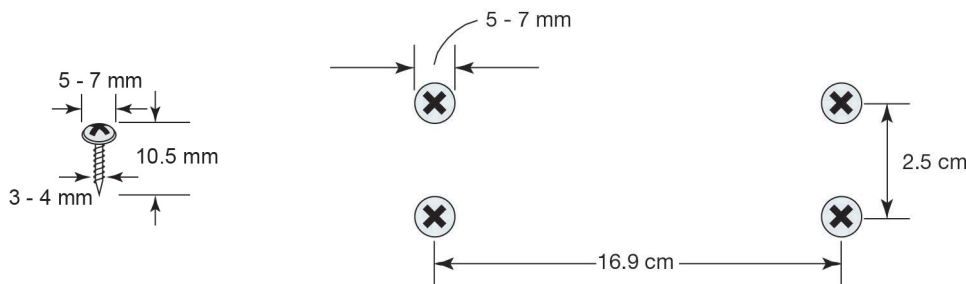

The head of the screws should be 5 to 7 mm in diameter, the shaft should be 3 to 4 mm in diameter, and the length of the screws should be at least 10.5 mm. Make sure to leave about 5 mm of space between the head and the wall.

Specifications

LAN

Ethernet 10/100 Mbps, RJ45, Auto MDI/MDIX
Protection Built-in 1.5 kV magnetic isolation

Serial Interface

Interface RS-232/422/485
No. of Ports 4 ports
Connector Type DB9 (male)
Signals
RS-232: TxD, RxD, RTS, CTS, DTR, DSR, DCD, GND
RS-422: Tx+, Tx-, Rx+, Rx-, GND
RS-485 (2-wire): Data+, Data-, GND
RS-485 (4-wire): Tx+, Tx-, Rx+, Rx-, GND
Serial Line Protection 15 kV ESD for all signals
RS-485 Data Direction Patented ADDC™

Serial Communication Parameters

Parity None, Even, Odd, Space, Mark
Data Bits 7, 8
Stop Bits 1, 2
Flow Control RTS/CTS
Transmission Speed 50 bps to 921.6 Kbps

Software Features

Operation Mode RTU Slave, RTU Master, ASCII Slave, ASCII Master
Utilities MGate Manager
Multi-Masters and Multi-Request 16 simultaneous TCP masters, 32 simultaneous requests for each TCP master

Power Requirements

Power Input	12 to 48 VDC
Power Connector	Power jack and terminal block
Power Consumption	385 mA @ 12 VDC, 110 mA @ 48 VDC

Environmental Limits

Operating Temperature	0 to 60°C (32 to 140°F)
Storage Temperature	-40 to 85°C (-40 to 185°F)
Ambient Relative Humidity	5 to 95% (non-condensing)
Altitude	Up to 2000 m (795 hPa); higher altitudes on demand

Note: Please contact Moxa if you require products guaranteed to function properly at higher altitudes.

Standards and Certifications

Safety	UL 60950-1, EN 60950-1
EMC	CE, FCC
EMI	EN 55032 Class A, FCC Part 15 Subpart B Class A
EMS	EN 55024, EN 61000-4-2 (ESD) Level 2, EN 61000-4-3 (RS) Level 2, EN 61000-4-4 (EFT) Level 2, EN 61000-4-5 (Surge) Level 2, EN 61000-4-6 (CS) Level 2, EN 61000-4-8 (PFMF) Level 1, EN 61000-4-11

Reliability

MTBF (mean time between failures)	MGate M3480: 1,242,173 hrs
-----------------------------------	----------------------------

Warranty

Period	5 years
--------	---------

6. Hardware: MB3170, MB3170I

This chapter provides hardware information for the MGate MB3170 and MB3170I.

Panel Layout

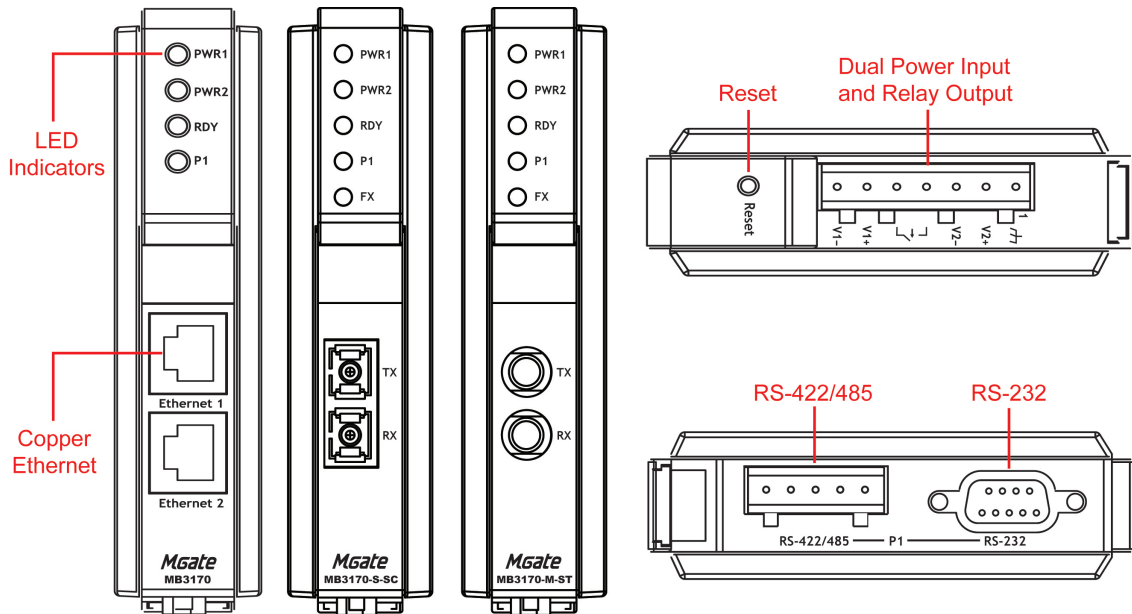

LED Indicators

Name	Color	Function
PWR1	Red	Power is being supplied to the power input.
PWR2	Red	Power is being supplied to the power input.
RDY	Red	Steady on: Power is on and unit is booting up. Blinking: IP conflict, the DHCP or BOOTP server did not respond properly, or a relay output occurred.
	Green	Steady on: Power is on and unit is functioning normally. Blinking: Unit is responding to software Locate function.
	Off	Power is off, or power error condition exists.
Ethernet	Amber	10 Mbps Ethernet connection.
	Green	100 Mbps Ethernet connection.
	Off	Ethernet cable is disconnected, or has a short.
P1	Amber	Serial port is receiving data.
	Green	Serial port is transmitting data.
	Off	No data is being transmitted or received through the serial port.
FX	Amber	Steady on: Ethernet fiber connection, but port is idle. Blinking: Fiber port is transmitting or receiving data.
	Off	Fiber port is not transmitting or receiving data.

Dimensions

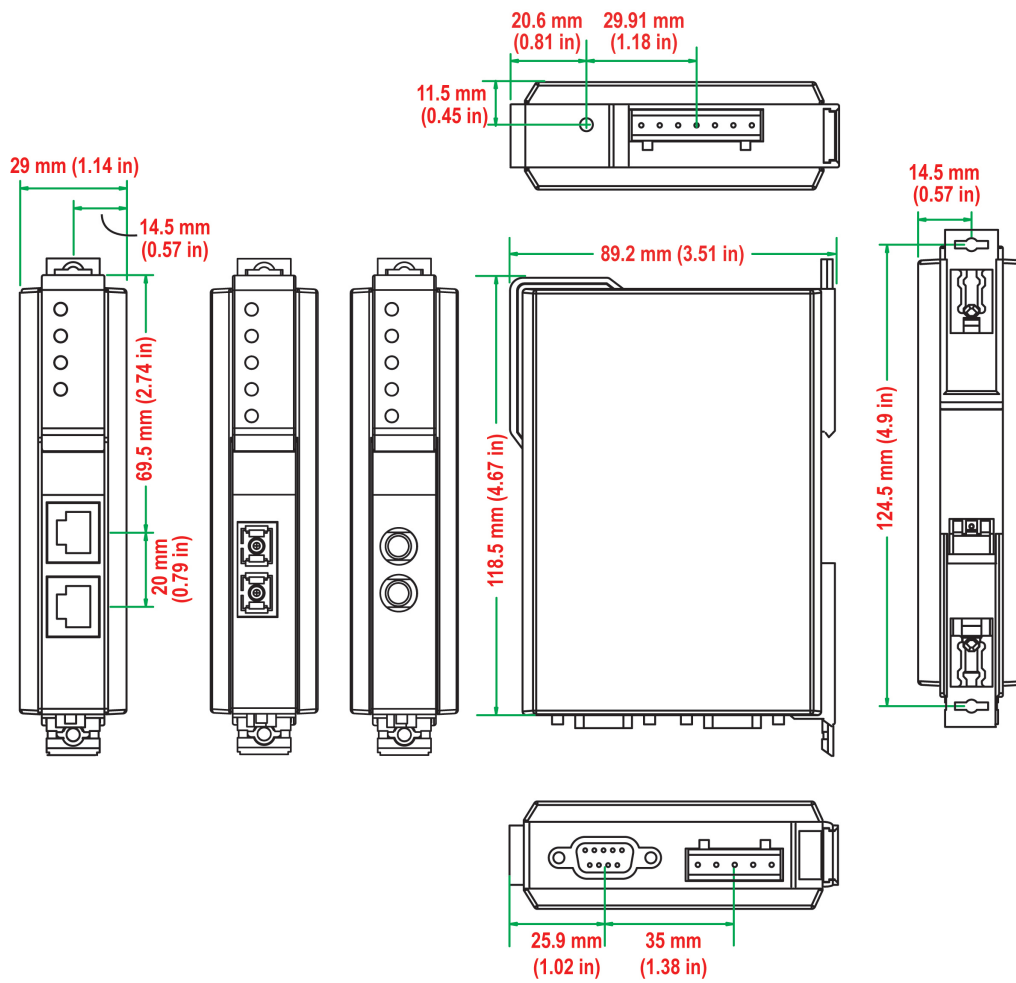

Jumpers

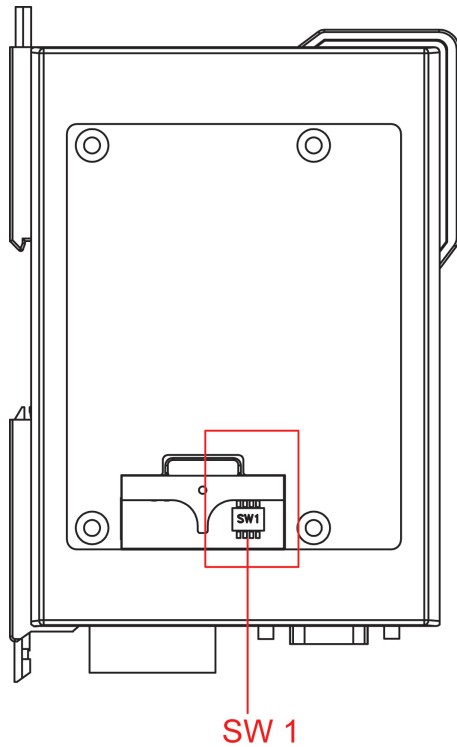

The DIP switches are located beneath the DIP switch panel on the side of the unit.

To add a 120 Ω termination resistor, set switch 3 to ON; set switch 3 to OFF (the default setting) to disable the termination resistor.

To set the pull high/low resistors to 150 K Ω , set switches 1 and 2 to OFF. This is the default setting.

To set the pull high/low resistors to 1 K Ω , set switches 1 and 2 to ON.

Switch 4 on the port's assigned DIP switch is reserved.



ATTENTION

Do not use the 1 K Ω pull high/low setting on the MGate MB3000 when using the RS-232 interface. Doing so will degrade the RS-232 signals and reduce the effective communication distance.

DIN-Rail and Wall Mounting

There are two sliders on the back of the unit for DIN-rail and wall mounting.

Mounting on a DIN-rail: Pull out the bottom slider, latch the unit onto the DIN-rail, and push the slider back in.

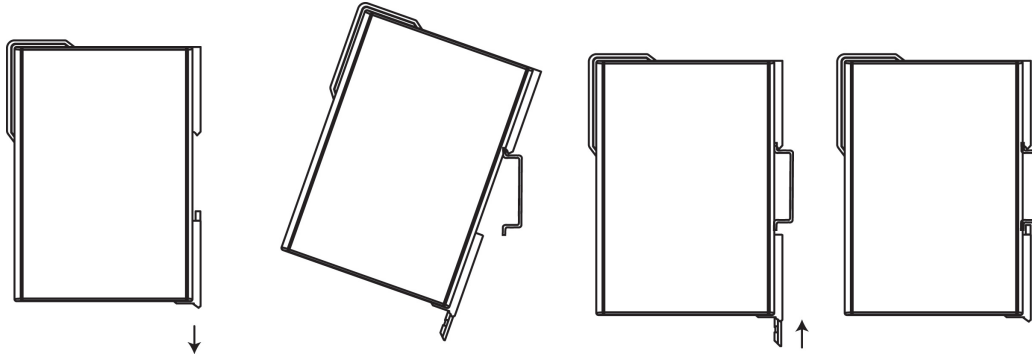

Mounting on the wall: Pull out both the top and bottom sliders and align the screws accordingly.

Mounting the MGate MB3170 Series on to a wall requires two screws. The heads of the screws should be 5 to 7 mm in diameter, the shafts should be 3 to 4 mm in diameter, and the length of the screws should be more than 10.5 mm.

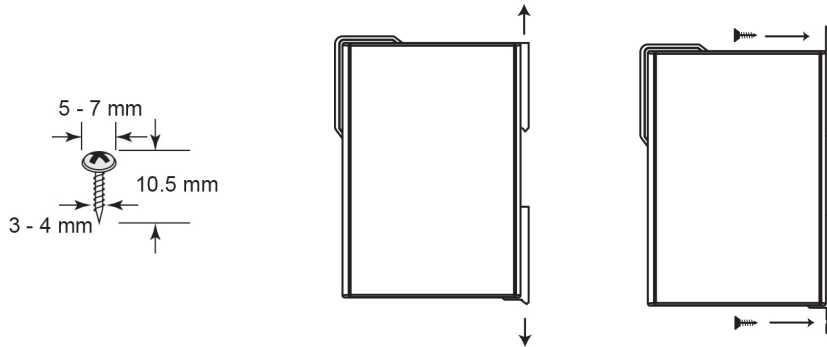

NOTE

Wall mounting is certified for use in maritime applications. The device must be installed more than 60 cm from the compass.

Specifications

LAN

Ethernet	10/100 Mbps, RJ45, Auto MDI/MDIX
Number of Ports	2 (1 IP, Ethernet cascade)
Connector	8-pin RJ45
Protection	Built-in 1.5 kV magnetic isolation

Optical Fiber Interface

Fiber Cable Type		100BaseFX		
		OM1	Multimode	Single-mode
			50/125 μm 800 MHz*km	G.652
Typical Distance		4 km	5 km	40 km
Wavelength	Typical (nm)	1300		1310
	TX Range (nm)	1260 to 1360		1280 to 1340
	RX Range (nm)	1100 to 1600		1100 to 1600
Optical Power	TX Range (dBm)	-10 to -20		0 to -5
	RX Range (dBm)	-3 to -32		-3 to -34
	Link Budget (dB)	12		29
	Dispersion Penalty (dB)	3		1

Note: When connecting a single-mode fiber transceiver, we recommend using an attenuator to prevent damage caused by excessive optical power.

Note: Compute the "typical distance" of a specific fiber transceiver as follows: Link budget (dB) > dispersion penalty (dB) + total link loss (dB).

Serial Interface

Interface	RS-232/422/485
No. of Ports	1 port
Connector Type	DB9 (male) for RS-232, terminal block for RS-422/485
Signals	RS-232: TxD, RxD, RTS, CTS, DTR, DSR, DCD, GND RS-422: Tx+, Tx-, Rx+, Rx-, GND RS-485 (2-wire): Data+, Data-, GND RS-485 (4-wire): Tx+, Tx-, Rx+, Rx-, GND
Serial Line Protection	15 kV ESD for all signals
Magnetic Isolation Protection	2 kV (for -I model)
RS-485 Data Direction	Patented ADDC™

Serial Communication Parameters

Parity	None, Even, Odd, Space, Mark
Data Bits	7, 8
Stop Bits	1, 2
Flow Control	RTS/CTS
Transmission Speed	50 bps to 921.6 Kbps

Software Features

Operation Mode	RTU Slave, RTU Master, ASCII Slave, ASCII Master
Utilities	MGate Manager
Multi-Masters and Multi-Request	32 simultaneous TCP masters, 32 simultaneous requests for each TCP master

Power Requirements

Power Input	12 to 48 VDC
Power Connector	Terminal block
Power Consumption (Input Rating)	<ul style="list-style-type: none"> MGate MB3170, MGate MB3170-T: 12 to 48 VDC, 435 mA (max.) MGate MB3170-M-ST, MGate MB3170-M-ST-T, MGate MB3170-M-SC, MGate MB3170-M-SC-T: 12 to 48 VDC, 510 mA (max.) MGate MB3170I, MGate MB3170I-T, MGate MB3170-S-SC, MGate MB3170-S-SC-T, MGate MB3170I-S-SC, MGate MB3170I-S-SC-T, MGate MB3170I-M-SC, MGate MB3170I-M-SC-T: 12 to 48 VDC, 555 mA (max.)
Relay Output	1 digital relay output to alarm (normal close): Current-carrying capacity 1 A @ 30 VDC

Environmental Limits

Operating Temperature	0 to 60°C (32 to 140°F) -40 to 75°C (-40 to 167°F) for “-T” models
Storage Temperature	-40 to 85°C (-40 to 185°F)
Ambient Relative Humidity	5 to 95% (non-condensing)
Altitude	Up to 2000 m (795 hPa); higher altitudes on demand

Note: Please contact Moxa if you require products guaranteed to function properly at higher altitudes.

Standards and Certifications

Safety	EN 60950-1, IEC 60950-1, UL 62368-1, IEC 62368-1
Hazardous Location	UL/cUL Class 1 Division 2 Groups A/B/C/D, ATEX Zone 2 Ex nA IIC T4 Gc
EMC	CE, FCC
EMI	EN 55032 Class A, FCC Part 15 Subpart B Class A
EMS	EN 55024, EN 61000-4-2 (ESD) Level 3, EN 61000-4-3 (RS) Level 3, EN 61000-4-4 (EFT) Level 4, EN 61000-4-5 (Surge) Level 3, EN 61000-4-6 (CS) Level 3, EN 61000-4-8 (PFMF) Level 1, EN 61000-4-11
Marine	DNV
Shock	IEC 60068-2-27
Freefall	IEC 60068-2-32
Vibration	IEC 60068-2-6

Reliability

MTBF (mean time between failures)	MGate MB3170: 1,349,710 hrs.
-----------------------------------	------------------------------

Warranty

Period	5 years
--------	---------

7. Hardware: MB3270, MB3270I

This chapter provides hardware information for the MGate MB3270 and MB3270I.

Panel Layout

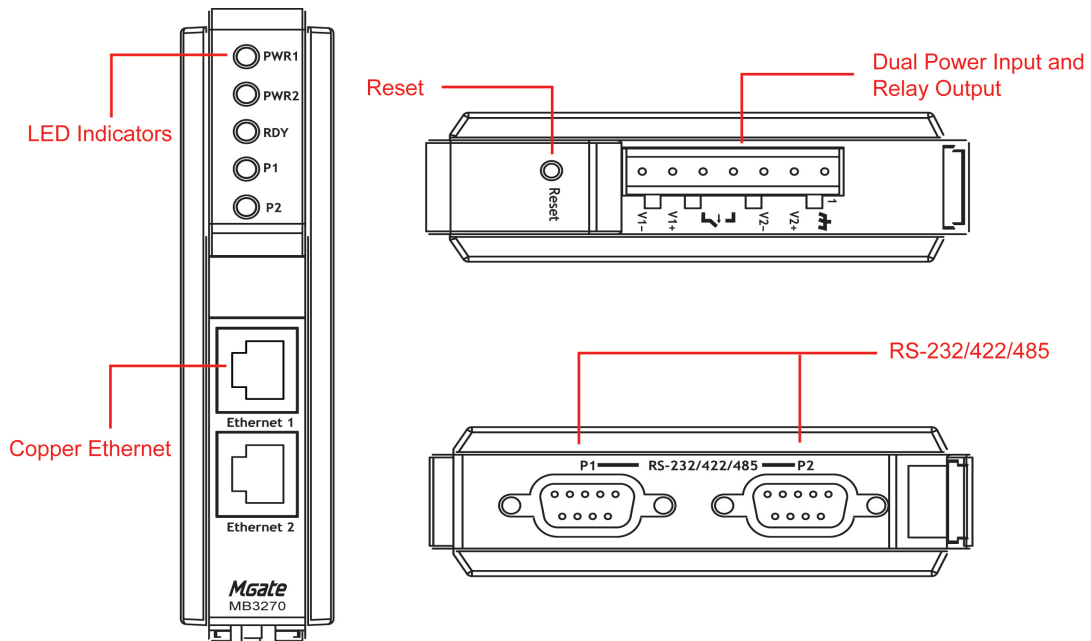

LED Indicators

Name	Color	Function
PWR1	Red	Power is being supplied to the power input.
PWR2	Red	Power is being supplied to the power input.
RDY	Red	Steady on: Power is on and unit is booting up. Blinking: IP conflict, the DHCP or BOOTP server did not respond properly, or a relay output occurred.
	Green	Steady on: Power is on and unit is functioning normally. Blinking: Unit is responding to software Locate function.
	Off	Power is off, or power error condition exists.
Ethernet	Amber	10 Mbps Ethernet connection.
	Green	100 Mbps Ethernet connection.
	Off	Ethernet cable is disconnected, or has a short.
P1, P2	Amber	Serial port is receiving data.
	Green	Serial port is transmitting data.
	Off	No data is being transmitted or received through the serial port.

Dimensions

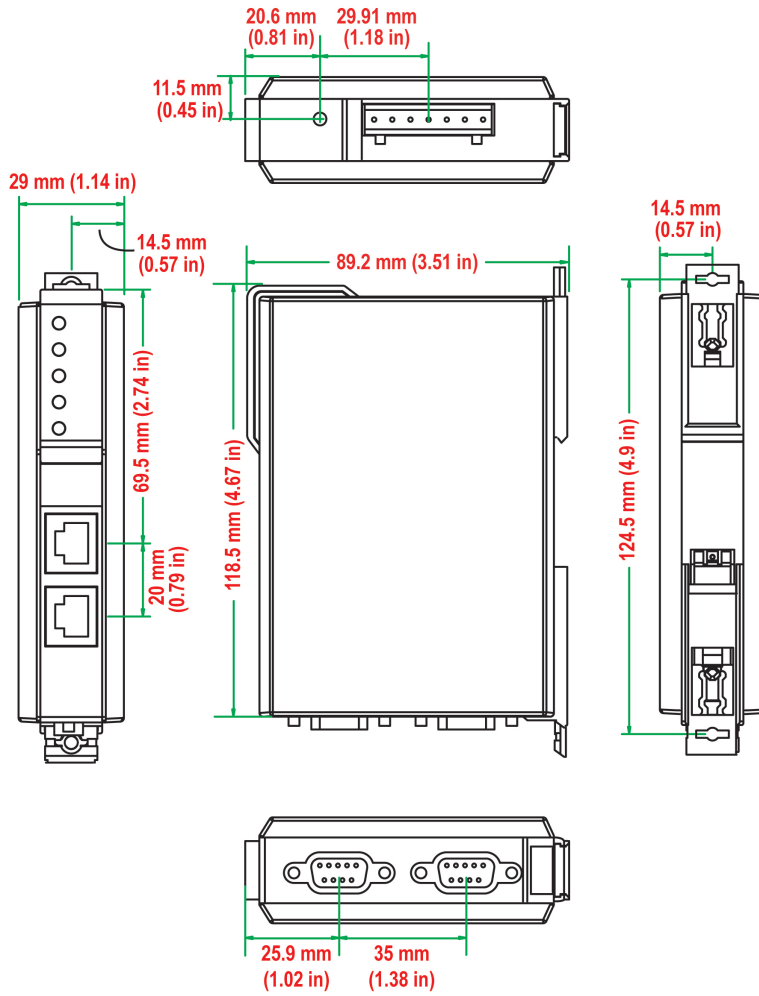

Jumpers

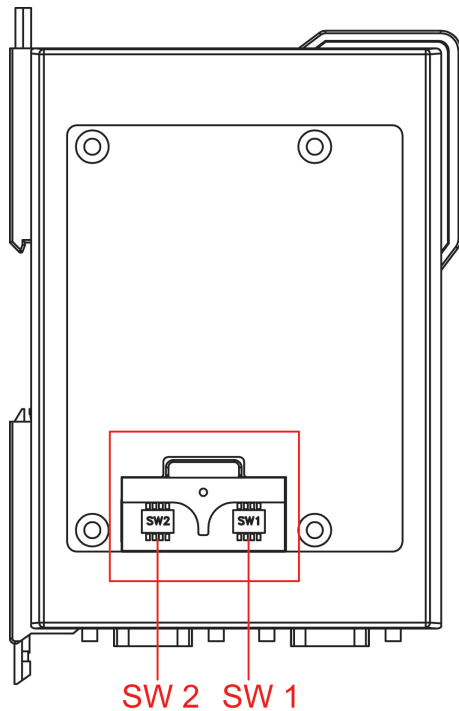

The DIP switches are located beneath the DIP switch panel on the side of the unit.

To add a 120 Ω termination resistor, set switch 3 on the port's assigned DIP switch to ON; set switch 3 to OFF (the default setting) to disable the termination resistor.

To set the pull high/low resistors to 150 K Ω , set switches 1 and 2 on the port's assigned DIP switch to OFF. This is the default setting.

To set the pull high/low resistors to 1 K Ω , set switches 1 and 2 on the port's assigned DIP switch to ON.

Switch 4 on the port's assigned DIP switch is reserved.



ATTENTION

Do not use the 1 K Ω pull high/low setting on the MGate MB3000 when using the RS-232 interface. Doing so will degrade the RS-232 signals and reduce the effective communication distance.

DIN-Rail and Wall Mounting

There are two sliders on the back of the unit for DIN-rail and wall mounting.

Mounting on a DIN-rail: Pull out the bottom slider, latch the unit onto the DIN-rail, and push the slider back in.

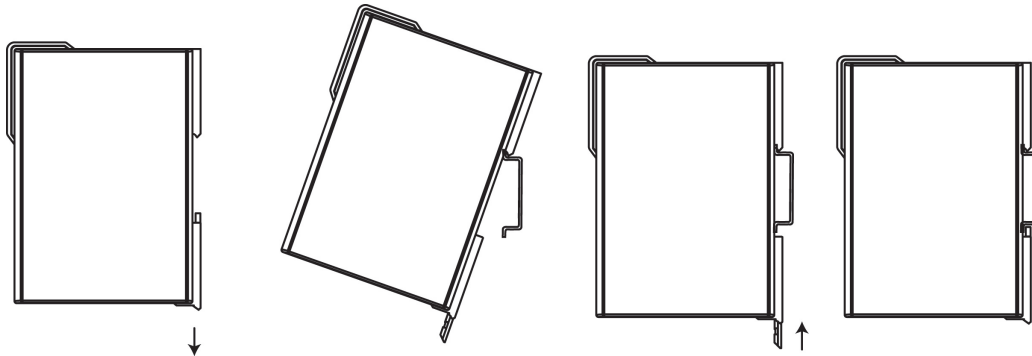

Mounting on the wall: Pull out both the top and bottom sliders and align the screws accordingly.

Mounting the MGate MB3270 Series on to a wall requires two screws. The heads of the screws should be 5 to 7 mm in diameter, the shafts should be 3 to 4 mm in diameter, and the length of the screws should be more than 10.5 mm.

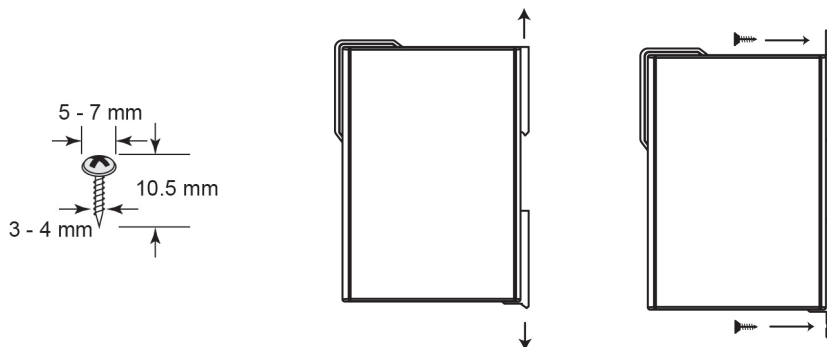

NOTE

Wall mounting is certified for use in maritime applications. The device must be installed more than 60 cm from the compass.

Specifications

LAN

Ethernet 10/100 Mbps, RJ45, Auto MDI/MDIX
Protection Built-in 1.5 kV magnetic isolation

Serial Interface

Interface RS-232/422/485
No. of Ports 2 ports
Connector Type DB9 (male)
Signals
RS-232: TxD, RxD, RTS, CTS, DTR, DSR, DCD, GND
RS-422: Tx+, Tx-, Rx+, Rx-, GND
RS-485 (2-wire): Data+, Data-, GND
RS-485 (4-wire): Tx+, Tx-, Rx+, Rx-, GND
Serial Line Protection 15 kV ESD for all signals
Magnetic Isolation Protection 2 kV (for -I model)
RS-485 Data Direction Patented ADDC™

Serial Communication Parameters

Parity	None, Even, Odd, Space, Mark
Data Bits	7, 8
Stop Bits	1, 2
Flow Control	RTS/CTS
Transmission Speed	50 bps to 921.6 Kbps

Software Features

Operation Mode	RTU Slave, RTU Master, ASCII Slave, ASCII Master
Utilities	MGate Manager
Multi-Masters and Multi-Request	32 simultaneous TCP masters, 32 simultaneous requests for each TCP master

Power Requirements

Power Input	12 to 48 VDC
Power Connector	Terminal block
Power Consumption (Input Rating)	<ul style="list-style-type: none"> • MGate MB3270, MGate MB3270-T: 12 to 48 VDC, 435 mA (max.) • MGate MB3270I, MGate MB3270I-T: 12 to 48 VDC, 510 mA (max.)
Relay Output	1 digital relay output to alarm (normal close): Current-carrying capacity 1 A @ 30 VDC

Environmental Limits

Operating Temperature	0 to 60°C (32 to 140°F) -40 to 75°C (-40 to 167°F) for "-T" models
Storage Temperature	-40 to 85°C (-40 to 185°F)
Ambient Relative Humidity	5 to 95% (non-condensing)
Altitude	Up to 2000 m (795 hPa); higher altitudes on demand

Note: Please contact Moxa if you require products guaranteed to function properly at higher altitudes.

Standards and Certifications

Safety	EN 60950-1, IEC 60950-1, UL 62368-1, IEC 62368-1
Hazardous Location	UL/cUL Class 1 Division 2 Groups A/B/C/D, ATEX Zone 2 Ex nA IIC T4 Gc
EMC	CE, FCC
EMI	EN 55032 Class A, FCC Part 15 Subpart B Class A
EMS	EN 55024, EN 61000-4-2 (ESD) Level 3, EN 61000-4-3 (RS) Level 3, EN 61000-4-4 (EFT) Level 4, EN 61000-4-5 (Surge) Level 3, EN 61000-4-6 (CS) Level 3, EN 61000-4-8 (PFMF) Level 1, EN 61000-4-11
Marine	DNV
Shock	IEC 60068-2-27
Freefall	IEC 60068-2-32
Vibration	IEC 60068-2-6

Reliability

MTBF (mean time between failures)	MGate MB3270: 1,236,384 hrs.
-----------------------------------	------------------------------

Warranty

Period	5 years
--------	---------

8. Pin Assignments

DB9 (Male)

The MGate MB3000 uses DB9 (male) serial ports to connect Modbus RTU or ASCII devices. Each port supports three serial interfaces: RS-232, RS-422, and RS-485 (both 2 and 4-wire).

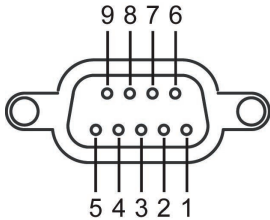

Pin	RS-232	RS-422/ RS-485 (4W)	RS-485 (2W)
1	DCD	TxD-	-
2	RxD	TxD+	-
3	TxD	RxD+	Data+
4	DTR	RxD-	Data-
5	GND	GND	GND
6	DSR	-	-
7	RTS	-	-
8	CTS	-	-
9	-	-	-

Terminal Block (RS-422, RS-485)

The MB3170 and MB3170I have a terminal block connector for RS-422 and RS-485 signals.

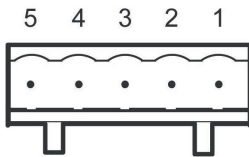

Pin	RS-422/ RS-485 (4W)	RS-485 (2W)
1	TxD+	-
2	TxD-	-
3	RxD+	Data+
4	RxD-	Data-
5	GND	GND

Power Input, Relay Output

The MGate MB3170/MB3270 gateways have dual power inputs for redundancy and a relay output for event warnings.

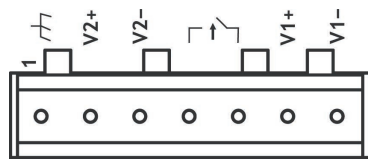

Shielded Ground	V2+	V2-	Relay Output	Relay Output	V1+	V1-
DC Power Input 1	DC Power Input 1	DC Power Input 1	Relay Output	Relay Output	DC Power Input 2	DC Power Input 2

9. Typical Applications

Ethernet Masters with Multiple Serial Slaves

Connect all Modbus devices over an Ethernet network

Most modern PLCs and host computers support Modbus TCP over Ethernet. In order to access discrete Modbus RTU/ASCII devices for data collection and control, they can rely on the MGate MB3000 Modbus gateway.

The MGate MB3000 supports Modbus TCP with up to 16 or 32 simultaneous connections. The serial interface supports both RS-232 and RS-422/485, selectable through software. Each serial port can be connected to one RS-232 or RS-422 serial device, or to 31 RS-485 serial devices.

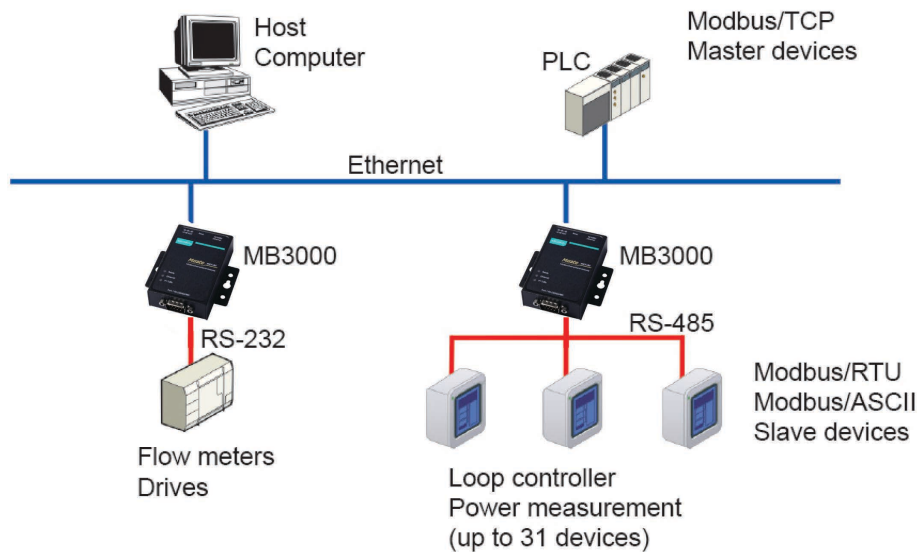

Serial Masters with Multiple Ethernet Slaves

Link a serial master device with Ethernet slave devices

Many HMI (Human Machine Interface) systems use a serial interface to connect to a discrete DCS (Data Control System). However, many DCSs are now Ethernet-based and operate as a Modbus TCP server device.

The MGate MB3000 Modbus gateway can link a serial-based HMI to distributed DCSs over an Ethernet network. Up to 32 Modbus TCP server devices are supported by each MGate MB3000.

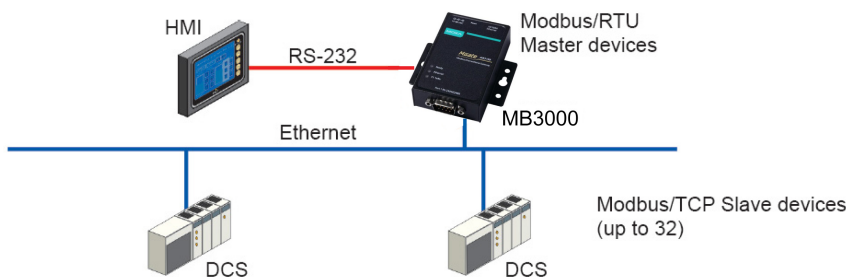

Modbus TCP Clients with ASCII and RTU Slaves

Link TCP master devices with both ASCII and RTU serial devices simultaneously

When integrating Modbus networks, you may encounter different Modbus serial networks that use different baudrates or a different protocol. Modbus ASCII might be used by some devices, while Modbus RTU is used by other devices.

The two and four-port MGate models can integrate serial Modbus networks that use different parameters or protocols. You can configure each serial port to a specific Modbus serial environment; set up a slave ID table. After configuration, only the gateway will be visible to Modbus TCP clients, and all serial devices will be integrated behind it.

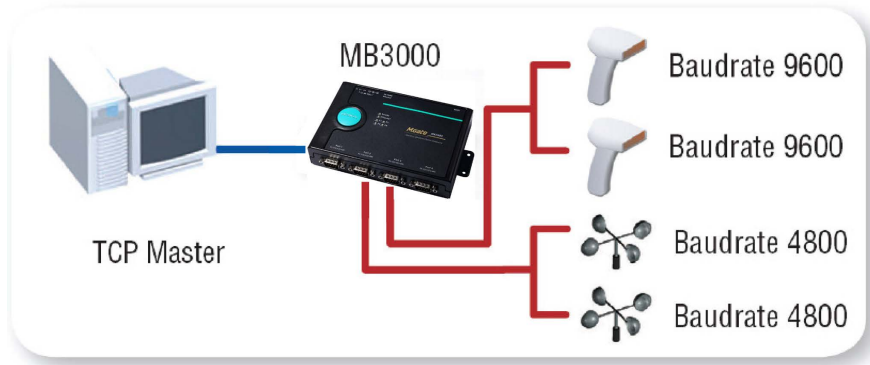

Serial Master with Serial Slaves over Internet

Let Modbus serial devices communicate over the Internet

Many Modbus devices communicate over RS-485, which limits the number of devices in a network to 32 and the transmission distance to 1.2 km.

With the MGate MB3000 Modbus gateway, you can link all Modbus devices over an Ethernet network. Up to 32 Modbus gateways can be installed in a single control network, so each device can now be accessed from anywhere the TCP/IP network can reach.

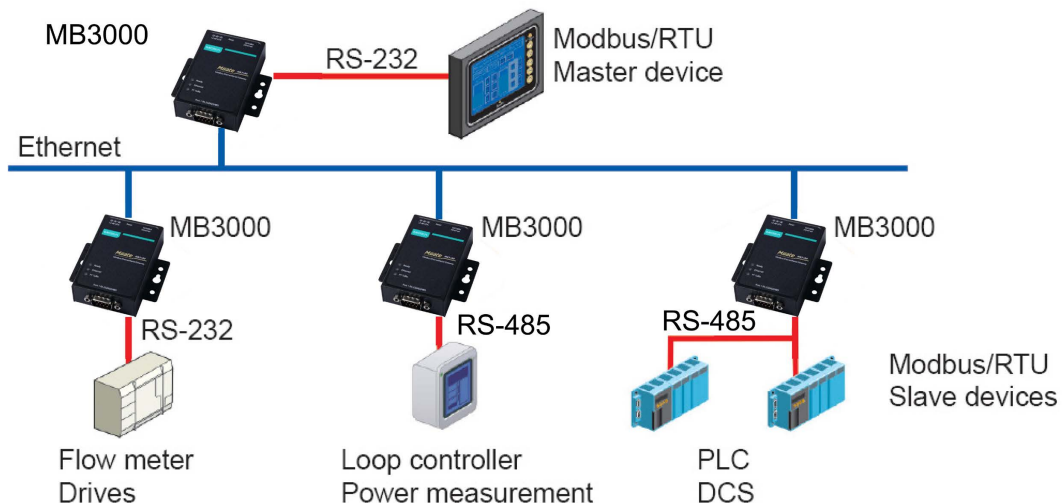

10. Configuring the Modbus Gateway

Installing the Software

The following instructions explain how to install MGate Manager, a utility for configuring and monitoring MGate MB3000 units over the network.

1. To install MGate Manager, please download it from Moxa's website at <http://www.moxa.com>. Then run the following setup program to begin the installation process:

MGM_Setup_[Version]_Build_[DateTime].exe

The filename of the latest version may have the following format:

MGM_Setup_Verx.x.x_Build_xxxxxxxx.exe, for example:



2. You will be greeted by the Welcome window. Click **Next** to continue.

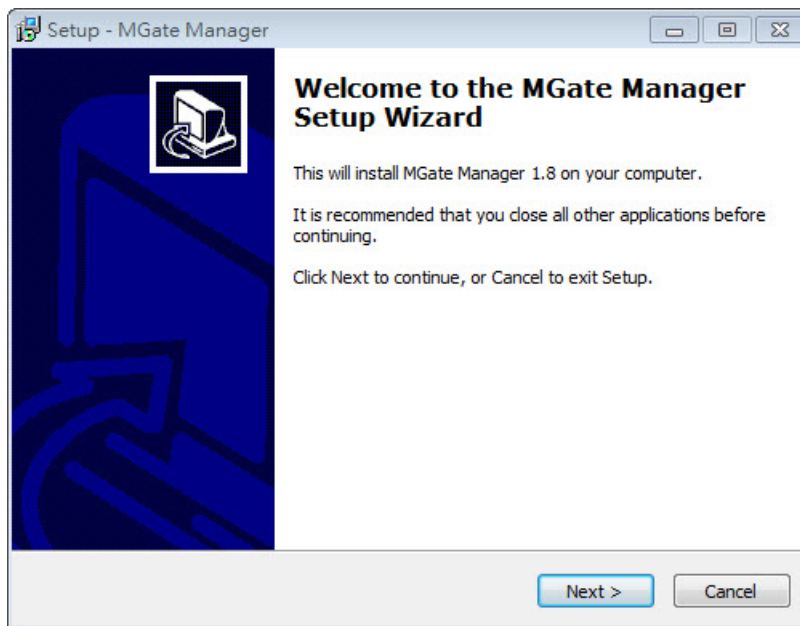

- When the **Select Destination Location** window appears, click **Next** to continue. You may change the destination directory by first clicking on **Browse....**

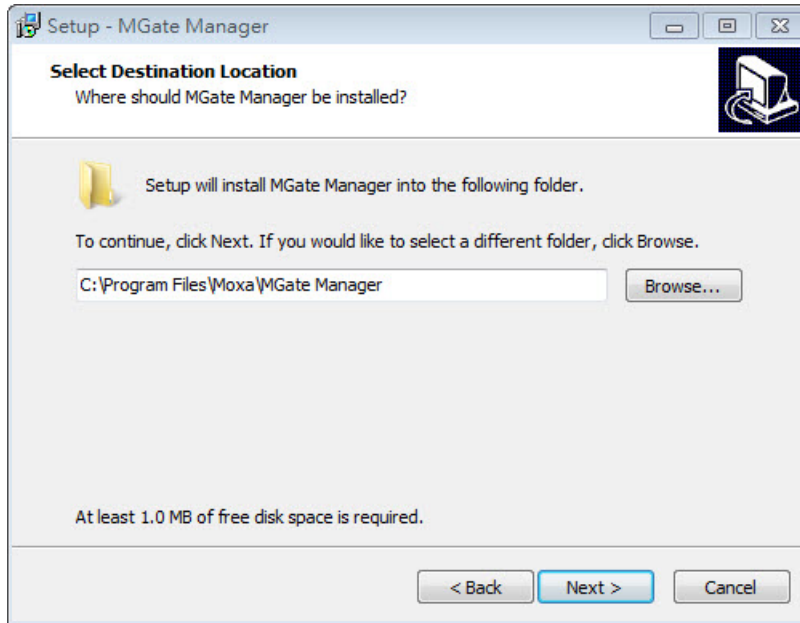

- When the **Select Additional Tasks** window appears, click **Next** to continue. You may select **Create a desktop icon** if you would like a shortcut to MGate Manager on your desktop.

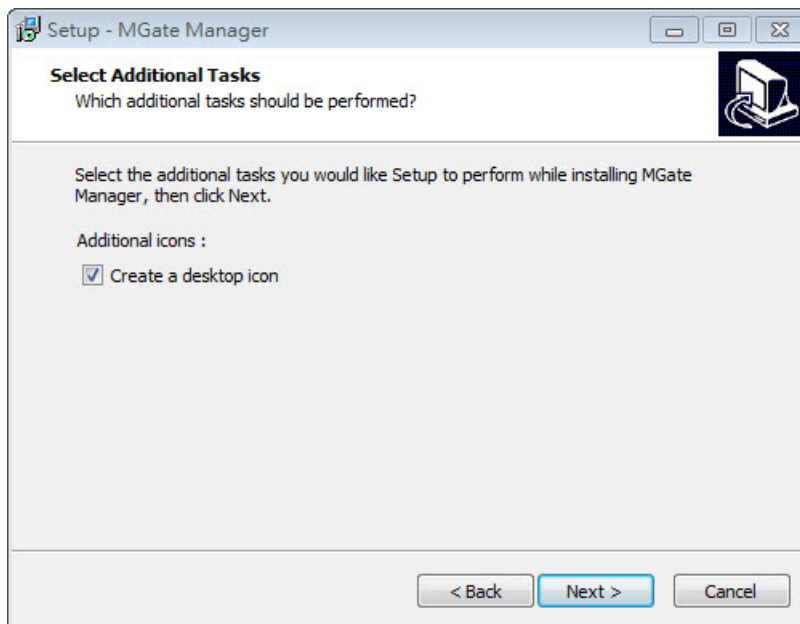

5. Click **Install** to start copying the software files.

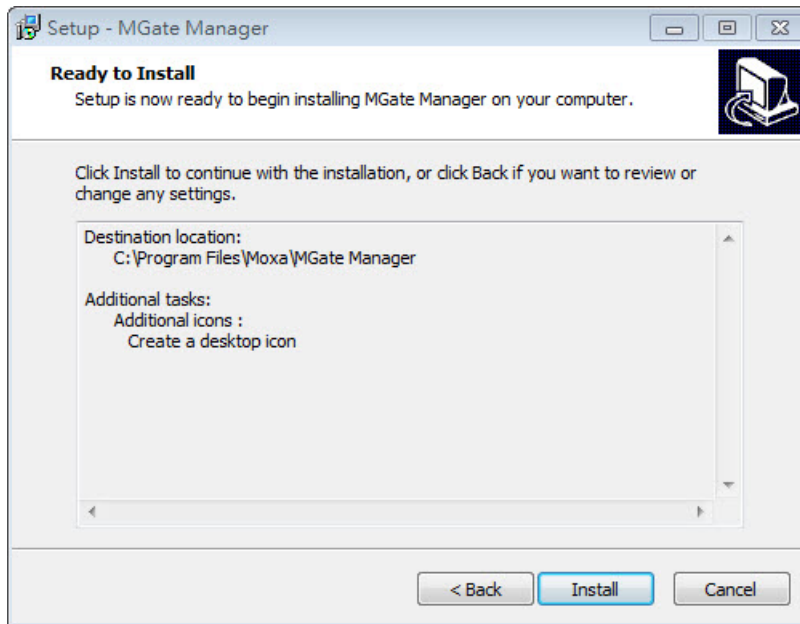

6. A progress bar will appear. The procedure should take only a few seconds to complete.

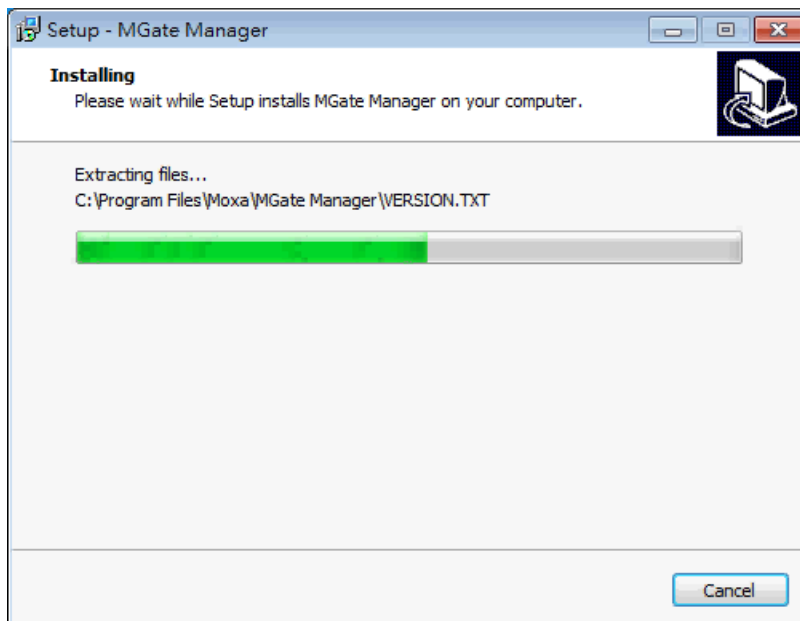

7. A message will indicate that MGate Manager is successfully installed. You may choose to run it immediately by selecting **Launch MGate Manager**.

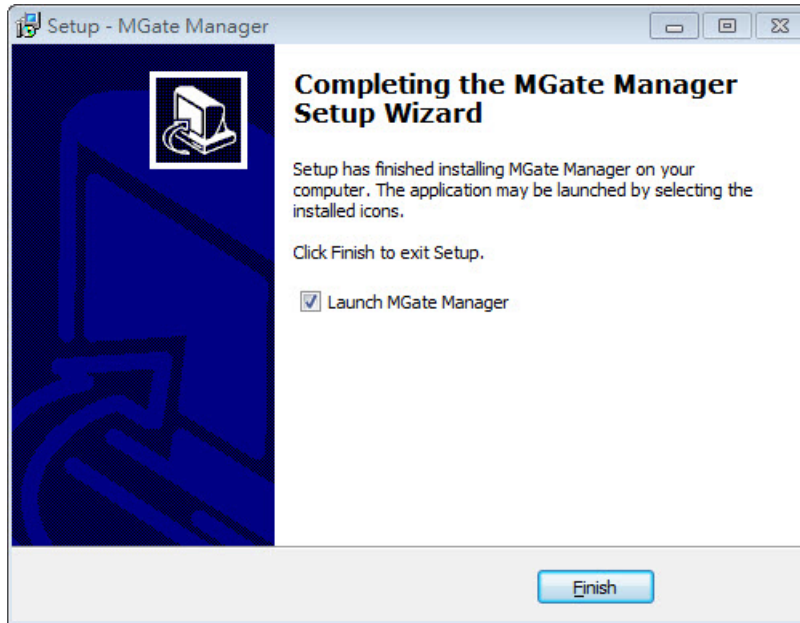

You may also open MGate Manager through **Start > Programs > MGate Manager > MGate Manager**, as shown below.

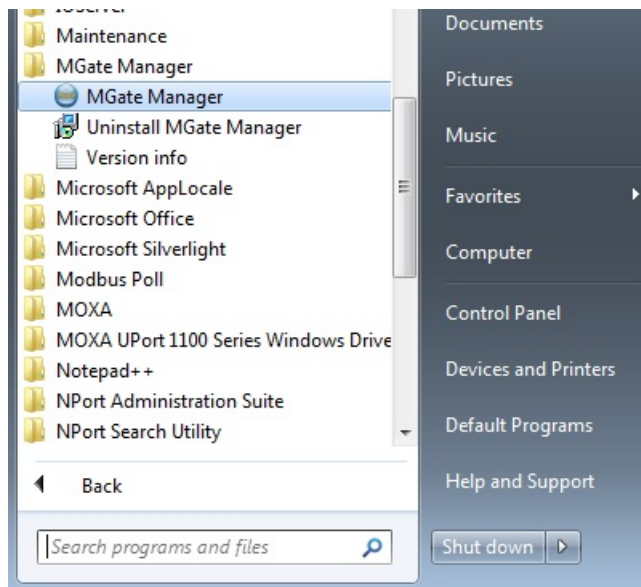

Starting MGate Manager

MGate Manager is a Windows-based utility that is used to configure the MGate MB3000.

Before running MGate Manager, make sure that your PC and the MGate MB3000 are connected to the same network. Alternatively, the MGate MB3000 may be connected directly to the PC for configuration purposes. Please refer to Chapter 2 for more details.

You may open MGate Manager from the Windows Start menu by clicking **Start > Programs > MGate Manager > MGate Manager**. The MGate Manager window should appear as shown below.

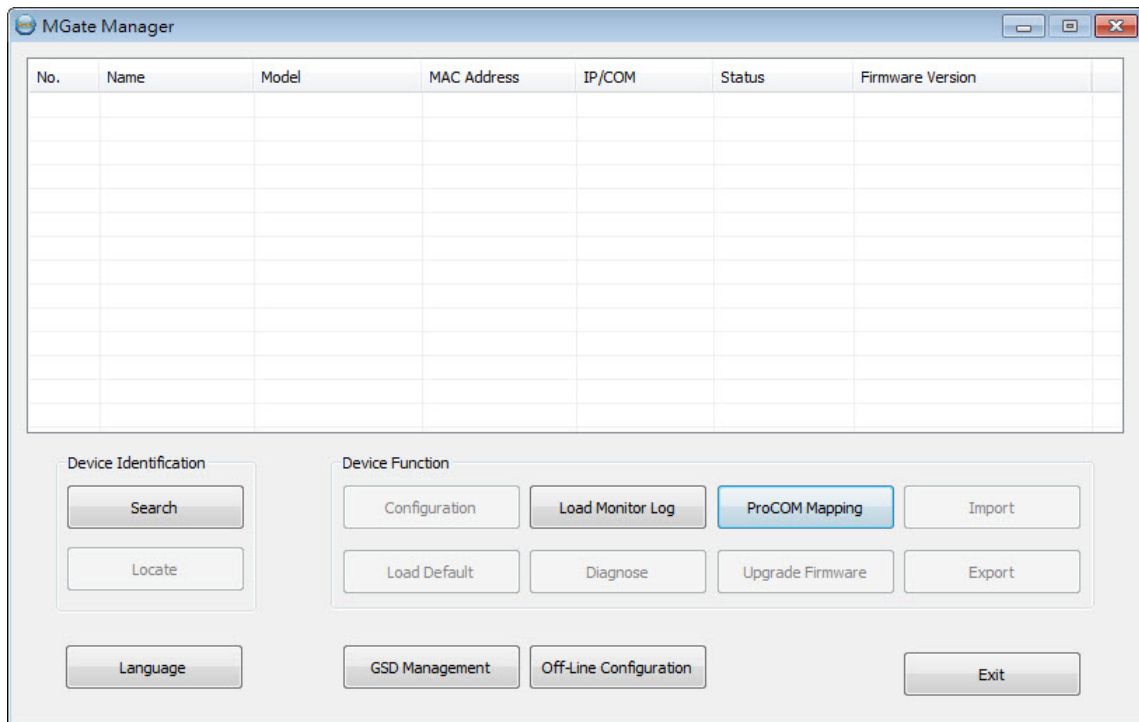

Change Language Setting

If you wish to run MGate Manager in a different language, you may click **Language** to change the language setting. A dialog box showing the available languages should appear as shown below.

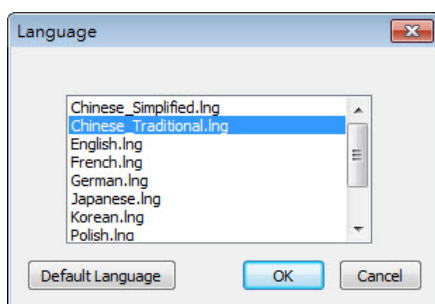

When you click **OK**, MGate Manager will immediately reflect your chosen language.



ATTENTION

Use **Default Language** before contacting Moxa Technical Support.

With support for multiple languages, MGate Manager is more user-friendly and accessible. However, if you need assistance from Moxa Technical Support, please change the language to **Default Language**. This will prevent any misunderstandings or confusion about MGate Manager menu items and commands as our engineers assist you.

The default language is English and will only be active for the current MGate Manager session. When you open MGate Manager again, the language will revert to your original setting.

Connecting to the Unit

MGate Manager needs to connect to the unit before the unit can be configured. There are two methods to connect to the unit. **Broadcast Search** is used to find every MGate MB3000 on the LAN. **Search by IP** attempts to connect to a specific unit by IP address, which is useful if the unit is located outside the LAN or can only be accessed by going through a router.

Except for the Broadcast Search feature, you can also use the Device Search Utility (DSU) to detect MGate gateways on your network, which can be downloaded from Moxa's website at <http://www.moxa.com>. This utility can further support multiple gateways configuration to ease your job.

Broadcast Search

Click **Search** and a new Search window will pop up.

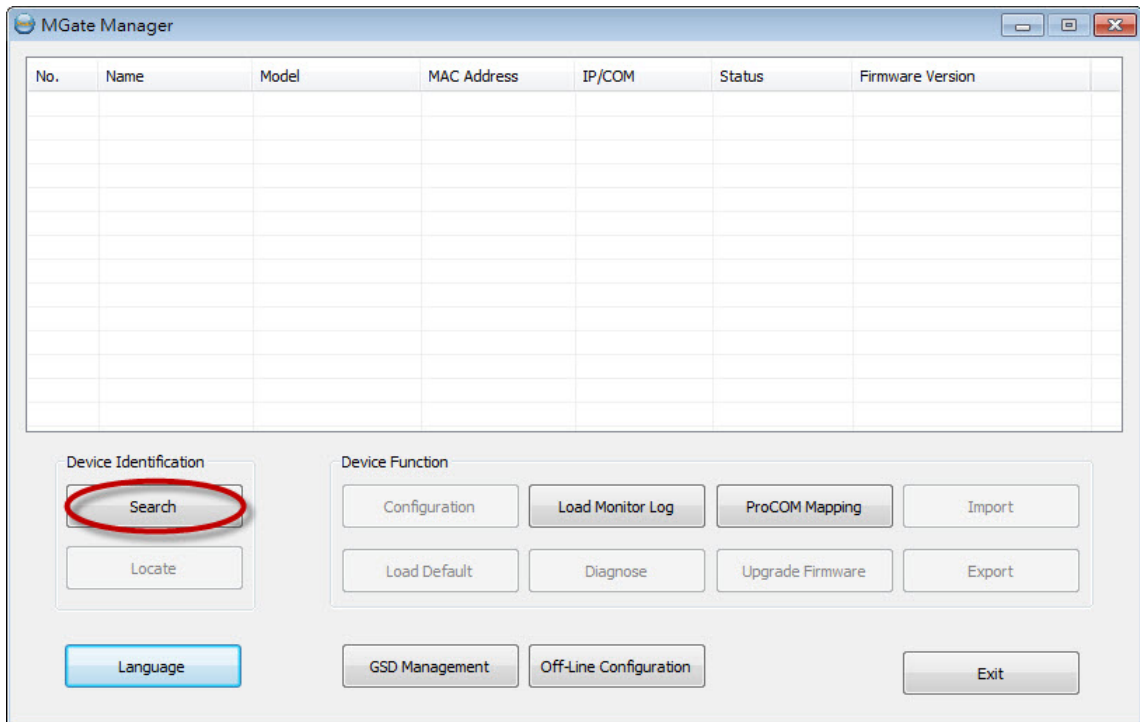

Select **Broadcast Search** and click **OK** to begin searching the LAN for all MGate MB3000 units.

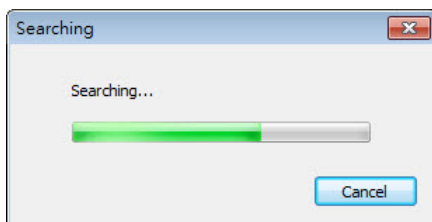
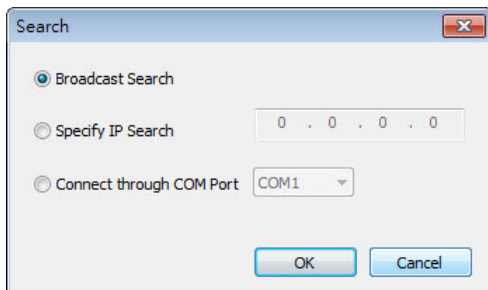

When the search is complete, every MGate MB3000 that is found on the LAN will appear in the window with MAC address and IP address. Simply select the one that you wish to configure.

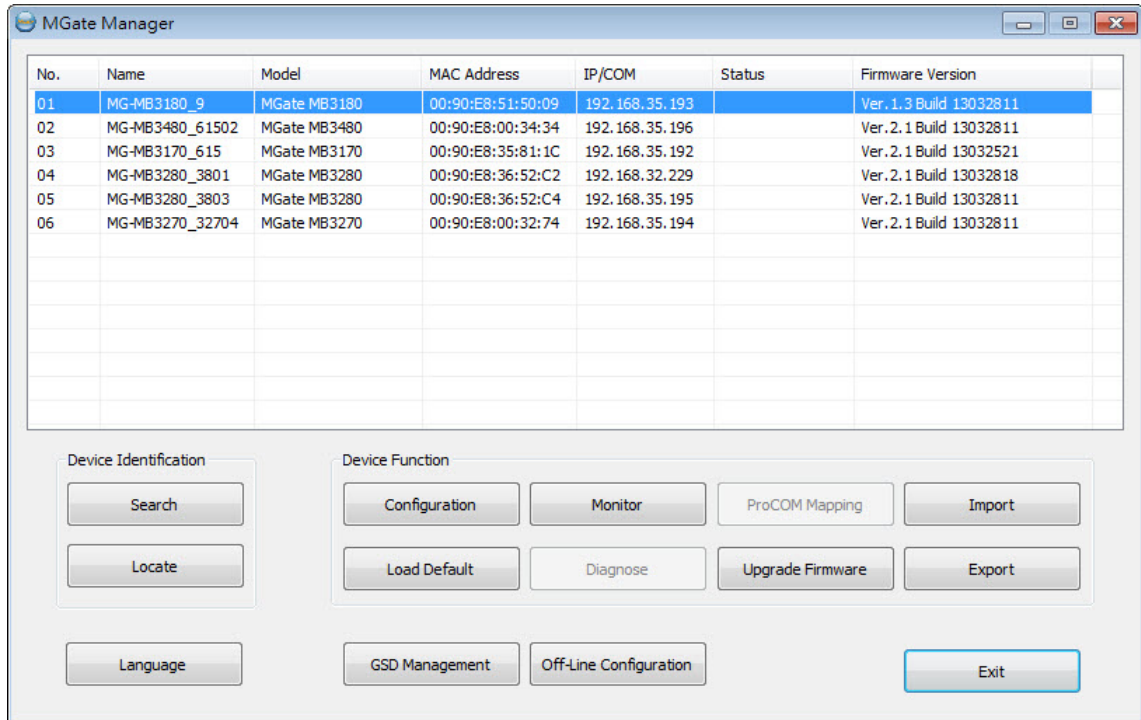

Specify IP Address

Click **Specify IP Search Address** if you know the IP address of the unit and wish to connect to it directly.

Enter the unit's IP address and click **OK**.

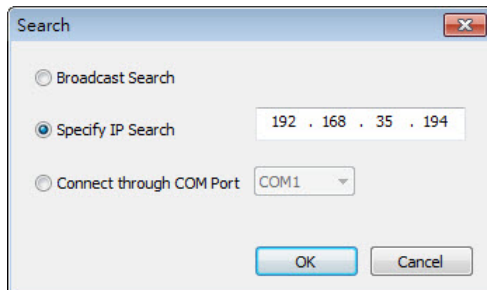

If the search is successful, the model items will be listed in MGate Manager. Configuration can be done in two ways: left click the item to begin the MGate Manager configuration; right click the item to begin the Web Console configuration. In this chapter, all the setting functions are introduced and highlighted by MGate Manager.

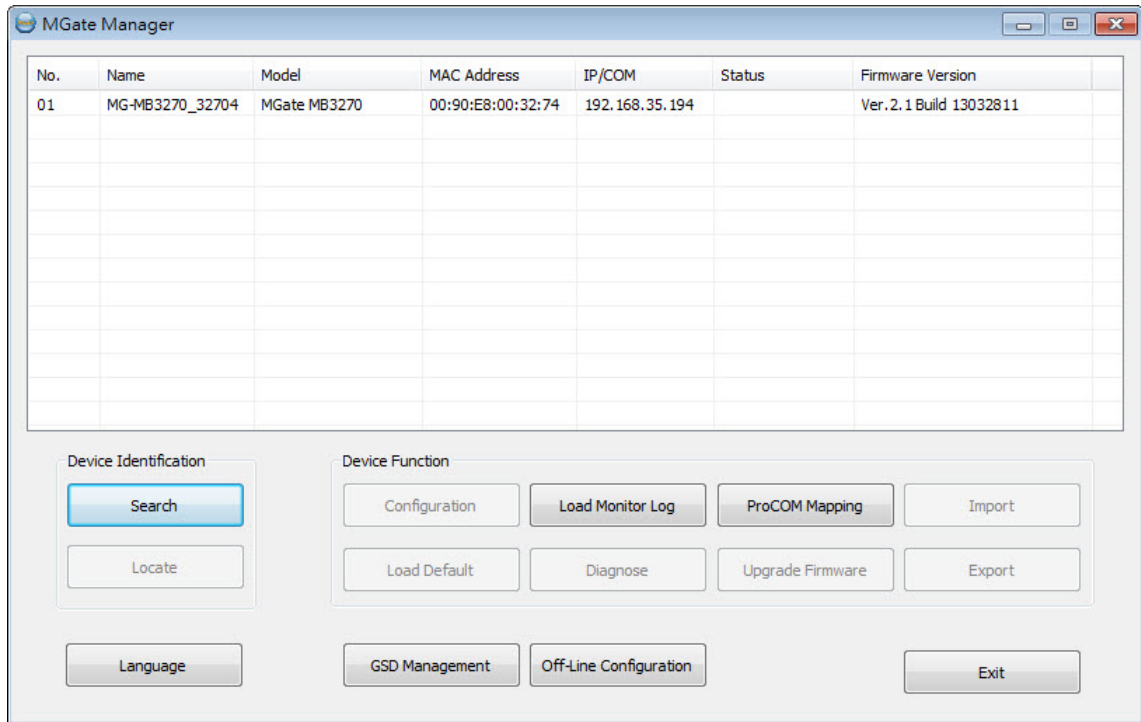

ATTENTION

If Search IP Address fails to locate the MGate MB3000, the IP address that you entered might be incorrect. Try doing the search again and re-entering the IP address carefully.

Another possibility is that the MGate MB3000 is located on the same LAN as your PC, but on a different subnet. In this case, you can modify your PC's IP address and/or netmask so that it is on the same subnet as the MGate MB3000. After your PC and the MGate MB3000 are on the same subnet, MGate Manager should be able to find the unit.

Modifying the Configuration

Once your unit is displayed in MGate Manager, click on it to select it. The Configuration button will become available. Click **Configuration** to open the configuration window.

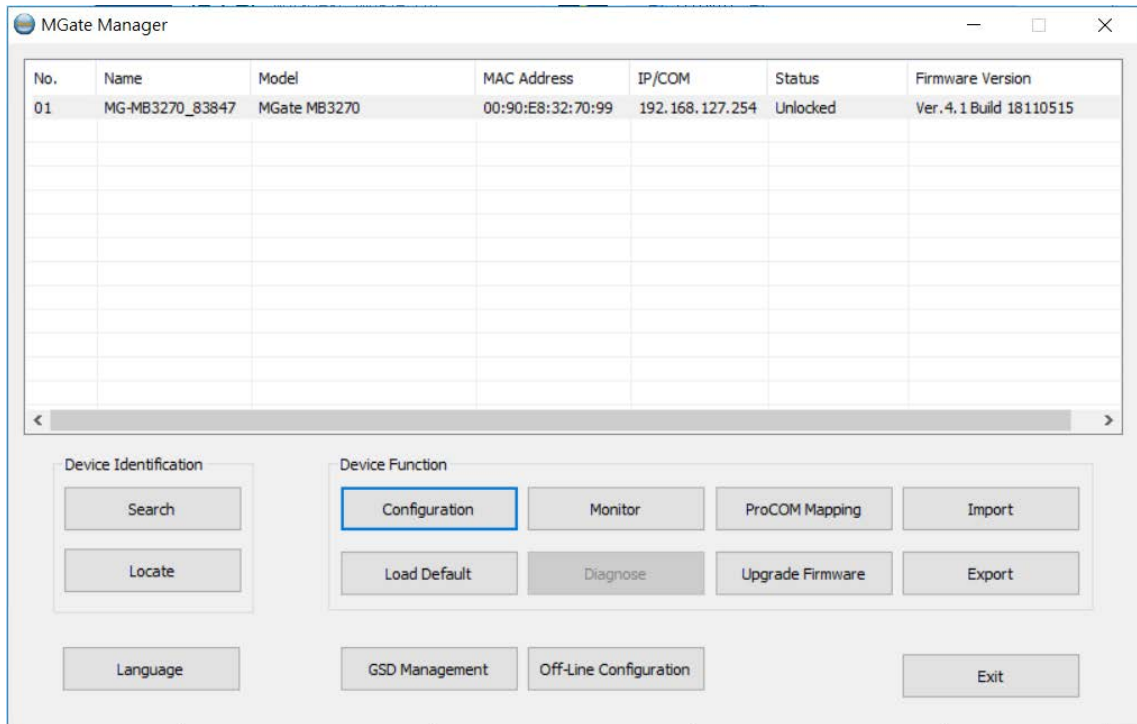

Password Protection

For security reasons, account and password protection is enabled by default, so you must provide the correct password to unlock the device before configuring the device.

Default account: **admin**
Default password: **moxa**

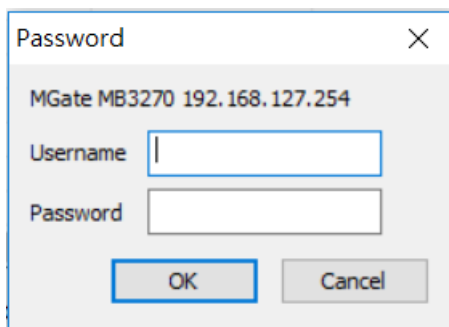

Basic Settings

On the first page, you can change the device name and time zone settings.

Server Setting

Parameter	Value	Notes
Server Name	(an alphanumeric string)	You can enter a name to help you identify the unit, such as the function, etc.
Server Location	(an alphanumeric string)	You can enter a name to help you identify the unit location. Such as "Cabinet A001."

Time Settings

The MGate MB3000 Series has a built-in real-time clock for time-calibration functions. Functions such as the log function can add real-time information to the message. You can do time calibration either followed by local time or time server. **Please note that this feature is not supported on the MB3180 gateway.**



ATTENTION

First-time users should select the time zone first. The console will display the real time according to the relevant GMT time zone. If you would like to modify the real-time clock, select **Local time**. The MGate's firmware will modify the GMT time according to the time zone.

Parameter	Value	Notes
Time Zone	User selectable time zone	This field shows the current selected time zone and allows you to select a different time zone.
Local Time	User adjustable time. (1900/1/1-2037/12/31)	Modify icon needs to be selected to adjust Local Time.
Time Server	IP or Domain address (e.g., 192.168.1.1 or time.stdtime.gov.tw)	This optional field specifies your time server's IP address or domain name if a time server is used on your network. The module supports SNTP (RFC-1769) for automatic time calibration. The MGate will request time information from the specified time server every 10 minutes.



ATTENTION

When modifying the local time, select the time zone first. The time display will be updated to reflect the specified time zone.

Network Settings

The Network tab is where the unit's network settings are configured. You can modify the Name, Network Configuration, IP Address, Netmask, Default Gateway, and DNS.

The screenshot shows a configuration window with tabs: Basic, Network (selected), Serial, Protocol, and System. Under the Network tab, there are several fields:

- Network Configure: Static (dropdown menu)
- IP Address: 192 . 168 . 127 . 254
- Netmask: 255 . 255 . 255 . 0
- Gateway: 255 . 255 . 255 . 255
- DNS1: 0 . 0 . 0 . 0
- DNS2: 0 . 0 . 0 . 0

Ethernet Settings

Parameter	Value	Notes
IP Configuration	Static IP, DHCP, BOOTP	Select Static IP if you are using a fixed IP address. Select one of the other options if the IP address is set dynamically.
IP Address	192.168.127.254 (or other 32-bit number)	The IP (Internet Protocol) address identifies the server on the TCP/IP network.
Netmask	255.255.255.0 (or other 32-bit number)	This identifies the server as belonging to a Class A, B, or C network.
Gateway	0.0.0.0 (or other 32-bit number)	This is the IP address of the router that provides network access outside the server's LAN.

DNS Server

Parameter	Value	Notes
DNS Server 1	0.0.0.0 (or other 32-bit number)	This is the IP address of the primary domain name server.
DNS Server 2	0.0.0.0 (or other 32-bit number)	This is the IP address of the secondary domain name server.

Serial Settings

The MGate MB 3000 Series serial interface supports RS-232, 2-wire RS-485, 4-wire RS-485, and RS-422 interfaces. You must configure baudrate, parity, data bits, and stop bits before using the serial interface with Modbus RTS/ASCII protocol. Incorrect settings will result in communication failures.

Port 1		Port 2	
Baudrate	Flow Control	Baudrate	Flow Control
115200	None	115200	None
Parity	FIFO	Parity	FIFO
None	Enable	None	Enable
Stop bit	Interface	Stop bit	Interface
1	RS232	1	RS232
Data bits		Data bits	
8		8	

Serial settings

Parameter	Value	Notes
Baudrate	50 bps to 921600 bps	
Parity	None, Odd, Even, Mark, Space	
Data bits	8	
Stop bits	1, 2	
Flow control	None, RTS/CTS, RTS Toggle	RTS Toggle will turn off RTS signals when there is no data to be sent. If there is data to be sent, RTS will turn on before data transmission and off after the transmission completes.
FIFO	Enable, Disable	The internal buffer of UART. Disabling FIFO can reduce the latency time when receiving data from serial communications, but this will also slow down the throughput.
Interface	RS-232, RS-422, RS-485 2 wire, RS-485 4 wire	
RTS on delay	0-100 ms	Only available for RTS Toggle
RTS off delay	0-100 ms	Only available for RTS Toggle

Protocol Settings

Mode

The MGate gateway supports Modbus RTU/ASCII and Modbus TCP protocols. The operation mode determines whether the device(s) that are connected to the serial port will operate as a master or a slave and whether the Modbus RTU or Modbus ASCII protocol will be used. There are four operation modes as follows:

Mode	Description
RTU Slave	Modbus RTU slave(s) will be connected to the serial port.
RTU Master	A Modbus RTU master will be connected to the serial port.
ASCII Slave	Modbus ASCII slave(s) will be connected to the serial port.
ASCII Master	A Modbus ASCII master will be connected to the serial port.
Disable	Protocol settings will be disabled in the serial port

- For entry-level models (MB3180, MB3280, and MB3480), Modbus TCP clients will control Modbus RTU/ASCII slaves, and Modbus RTU/ASCII masters will control Modbus TCP servers.
- For advanced models (MB3170, MB3270), both Modbus TCP and Modbus RTU/ASCII masters can control Modbus TCP and Modbus RTU/ASCII slaves.

Use the radio buttons to select the desired operation mode for each serial port on the Modbus gateway. Select the **ProCOM Enable** checkbox located in the center of the page to enable ProCOM. For detailed information, refer to the ProCOM function description in this manual.

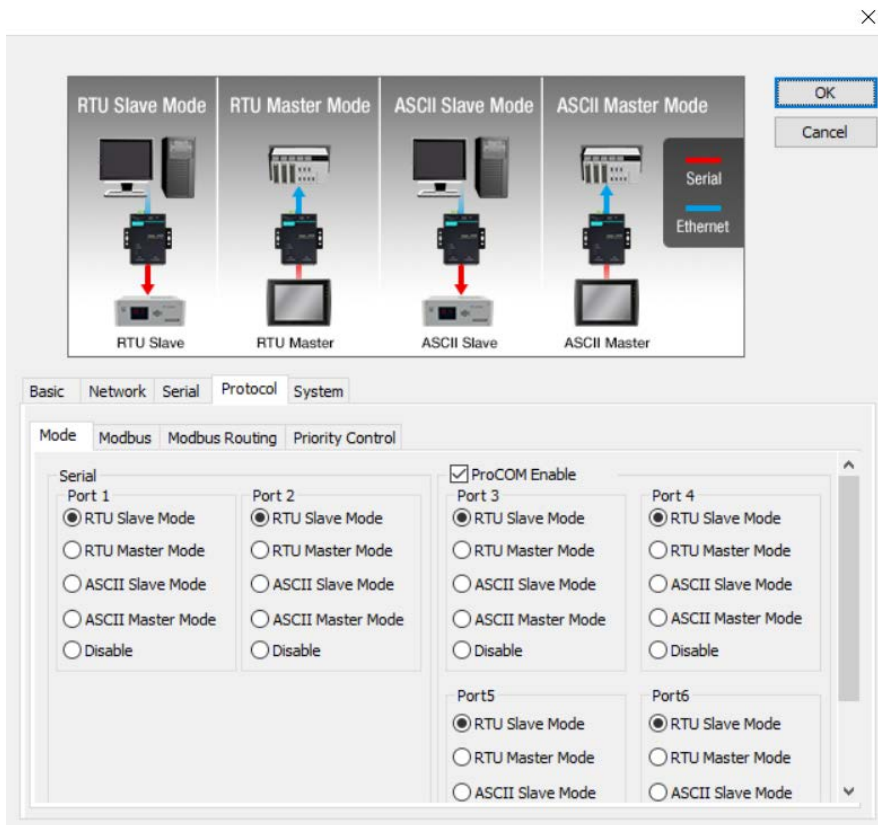

ProCOM

ProCOM is a Moxa proprietary function that creates virtual serial ports on the MGate MB3x70 Series to make fieldbus gateway communications more versatile. This intelligent fieldbus gateway mimics the behavior of a native serial port when transmitting data to the desired destination. PCs can use ProCOM to communicate over the Ethernet with serial devices connected to the MGate MB3x70 as if they were connected to the PC's native COM ports. This advanced feature only works with the MGate MB3x70 Series. For the detailed ProCOM mapping configuration, please check **ProCOM Mapping**.

Modbus

The Modbus tab is where certain adjustments can be made to fine-tune the communication between different Modbus networks. You can configure Initial Delay, Modbus TCP Exception, Slave Channel, and Response Time-out.

The screenshot shows the Modbus configuration window with the following settings:

- Initial Delay:** 0 (0-30000 ms)
- Modbus TCP Exception:** Disable, Enable
- Slaves Channel:** Port 1, Port 2, TCP / ProCOM
- Listen Port:** 502 (1-65535)
- Response Time-out:** 1000 (10-120000 ms)
- Response Time-out Detected Report:** Auto Detection
- Interval Time-out:**
 - Inter-character Time-out:** 0 (10-500ms, Default: 0ms)
 - Inter-frame Delay:** 0 (10-500ms, Default: 0ms)

Parameter	Value
Initial Delay	Numeric
Modbus TCP Exception	Enable or Disable
Slave Channel	Port 1, Port 2, TCP/ProCOM
Listen Port	1-65535
Response Time-out	Numeric
Inter-character Time-out	10-500 ms, Default: 0 ms
Inter-frame Delay	10-500 ms, Default: 0 ms

Initial Delay

Some Modbus slaves may take more time to boot up than other devices. For certain environments, this may cause the entire system to suffer from repeated exceptions during the initial boot-up. You can force the MGate to wait after booting up before sending the first request with the **Initial Delay** setting.

Modbus TCP Exception

The MGate MB3000 is a protocol gateway that transparently passes requests and responses between the Ethernet and serial interfaces. In some situations, it may be necessary for the gateway to return an exception in response to a request from a Modbus TCP clients. This is enabled or disabled with the **Modbus TCP Exception** setting. When enabled, the unit can return two types of exceptions:

Exception	Conditions
Time-out	There is no response from the slave. Maybe the device is offline or the serial cable is broken. (Exception code = 0x0B, MB_EXC_NORESP)
Request dropped	There are two situations that will result in this exception: The request queue is full, and 32 request queue is for each master. (Exception code = 0x06, MB_EXC_BUSY) The destination ID is not included in the slave ID table. (Exception code = 0x0A, MB_EXC_UNAVAILABLE)

Not all Modbus TCP clients require this exception, so it is up to you to determine if this setting should be enabled.

Modbus TCP Port

Allows you to change the Modbus TCP listen port from the default value (502).

Slave Channel and Response Time-out

According to the Modbus standard, the time that it takes for a slave device to respond to a request is defined by the device manufacturer (please refer to Appendix A for details). Based on this response time, a master can be configured to wait a certain amount of time for a slave's response. If no response is received within the specified time, the master will disregard the request and continue operation. This allows the Modbus system to continue operation even if a slave device is disconnected or faulty.

On the MGate MB3000, the **Response Time-out** field is used to configure how long the gateway will wait for a response from a Modbus ASCII or RTU slave. This field is set independently for each serial port, which is selected through the **Slave Channel** field. Please refer to your device manufacturer's documentation to manually set the response time-out.

The MGate MB3000 also provides automatic calibration of the response time-out. Instead of manually figuring out the appropriate setting, you can click **Auto Detection** to have the MGate figure out the setting for you. Once a value has been recommended, you can fine-tune it for best performance.

Inter-Character Time-Out

Use this function to determine the time-out interval between characters for Modbus devices that cannot receive Rx signals within an expected time interval. If the response is timed out, all received data will be discarded. Note that this time-out mechanism only works in RTU slave mode. The MGate MB3000 will automatically determine the time-out interval if the time-out value is set to 0.

Inter-Frame Delay

In Modbus RTU slave mode, user can determine the time-delay to transmit the data frame received from the slave device to the upstream. The MGate MB3000 will automatically determine the time interval if it is set to 0.

Modbus Routing

The **Modbus Routing** tab is where the Modbus slave IDs are managed. The definitions on this tab determine how Modbus requests will be routed to the serial ports by the gateway.

Chann...	Local Interface	Local IP Address / TCP Port	Definition

C...	Routing	Type	Slave ID Range (Virtual<->Real)	Definition
01	Manual	Modbus Serial	001 - 005 <-> 001 - 005	Port1 (Serial)
02	Manual	Modbus Serial	006 - 010 <-> 006 - 010	Port2 (Serial)
03	Manual	Modbus Serial (...)	000 - 000 <-> 000 - 000	Port3 (ProCOM)

Port Routing Table

The MGate MB3000 gateways support two kinds of port routing mechanism: by **IP address** and by **TCP port**. The Modbus master can communicate with the Modbus slave devices connected to a specific serial port on the gateway by assigning an IP address or TCP port to the specified serial port. Under these two kinds of port routing mechanisms, each serial port can be accessed by up to four Modbus masters.

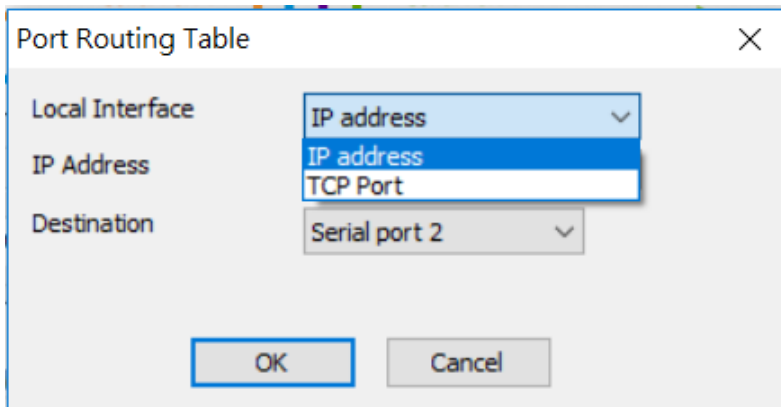

Port Routing Table

Local Interface: IP address

IP Address: IP address, TCP Port

Destination: Serial port 2

OK Cancel

For example, you could assign TCP ports 2001 to 2004 to serial ports 1 to 4, respectively. When the gateway receives a Modbus request designated for TCP port 2001, it will forward the Modbus request to serial port 1 directly. Similarly, if it receives a Modbus request designated for TCP port 2004, it will forward the Modbus request to the serial port 4 directly.

The MGate MB3000 gateways can forward the Modbus requests from different IP addresses to a specific serial port. For example, if IP address 192.168.1.1 is assigned to serial port 1, and when the gateway receives a Modbus request sent to 192.168.1.1, the gateway will forward the Modbus request to serial port 1 directly.

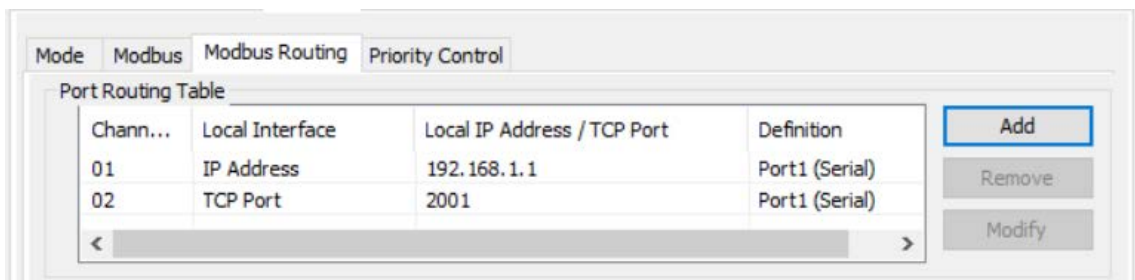

Mode Modbus Modbus Routing Priority Control

Port Routing Table

Chann...	Local Interface	Local IP Address / TCP Port	Definition
01	IP Address	192.168.1.1	Port1 (Serial)
02	TCP Port	2001	Port1 (Serial)

Add Remove Modify

With port routing mechanisms, Modbus slave ID routing can be simpler and more effective by giving users the flexibility to define a multirouting mechanism.

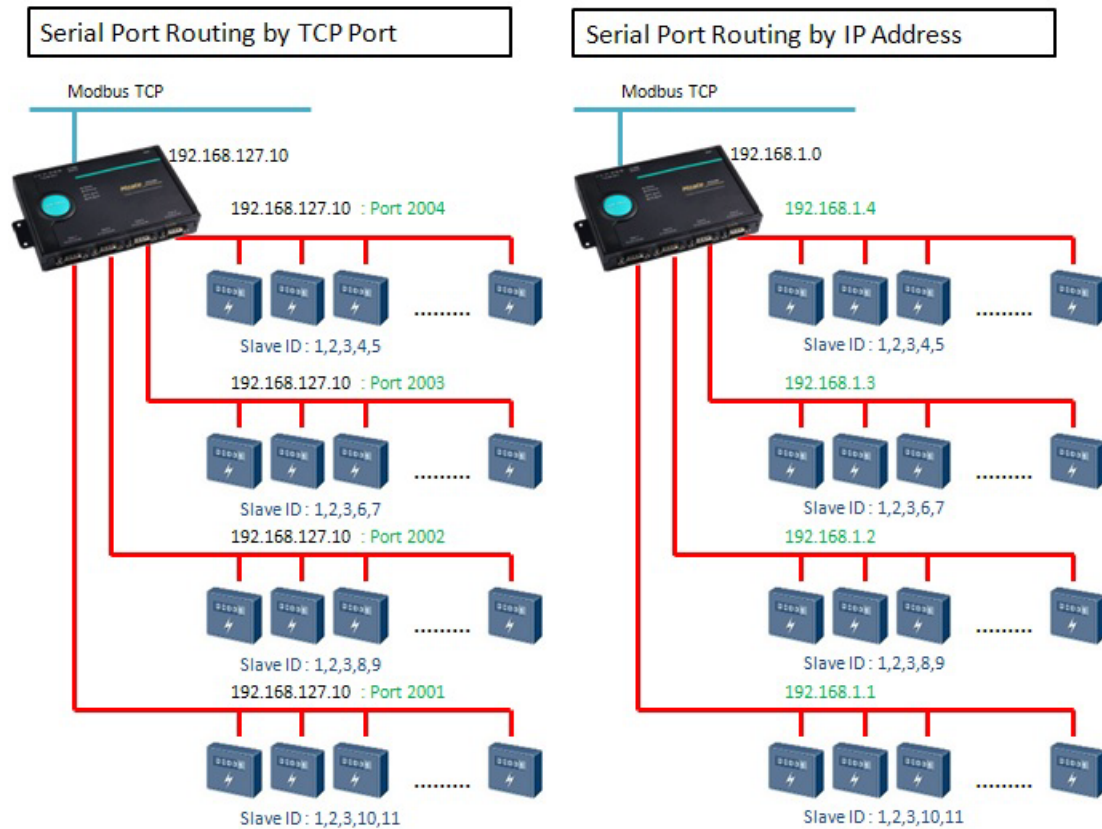

Slave ID Table

With the slave ID table, a routing mechanism is achieved for gateways with two or more serial ports. Since the Modbus devices (all with different slave IDs) are connected to different serial ports on a gateway, the Modbus requests should be routed to the specific serial port that connects the targeted Modbus slave device.

This keeps communication efficient and prevents devices on other ports to receive an unrelated Modbus request, resulting in slowing down the whole system. The slave ID table is used to handle the routing mechanism.

Traditionally, there is a factory default routing. For example, the Modbus requests with slave ID 001~005 will be routed to serial port1; the Modbus requests with slave ID 006~010 will be routed to serial port2. Users have to set their own customized routing. Select the one you want to set, and click **Add/Remove/Modify** buttons to change the existing routing. Set each port one by one.

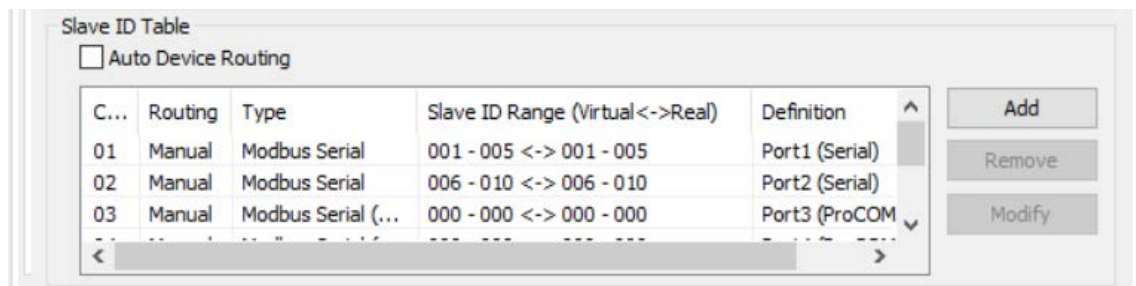

Auto Device Routing (patented)

The Moxa Modbus gateways provide an auto routing mechanism that eliminates the burdensome task of setting the slave ID table manually. Now, users no longer need to set the bothersome routing table. The Moxa Modbus gateways will help you detect and route correctly.

Click the checkbox for **Auto Device Routing**, and a message window will pop up.

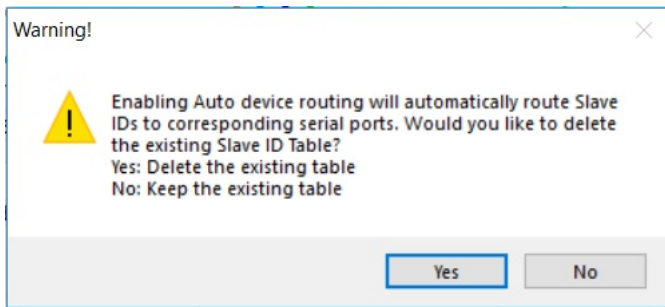

Click **Yes** to delete the existing (factory default or user-set) routing table; the auto-routing mechanism will automatically find the correct serial port that connects the target Modbus device. Moreover, if a device is added to the gateway later, the gateway can also route it correctly. Note that the routing table will be cleared as the warning message. The Slave ID table is then shown as in the figure below.

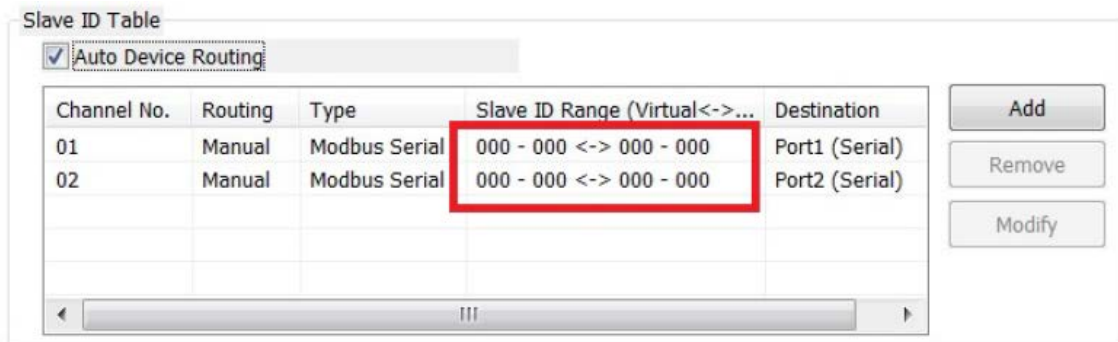

Users can only check the result of auto-detect routing table through the web console.

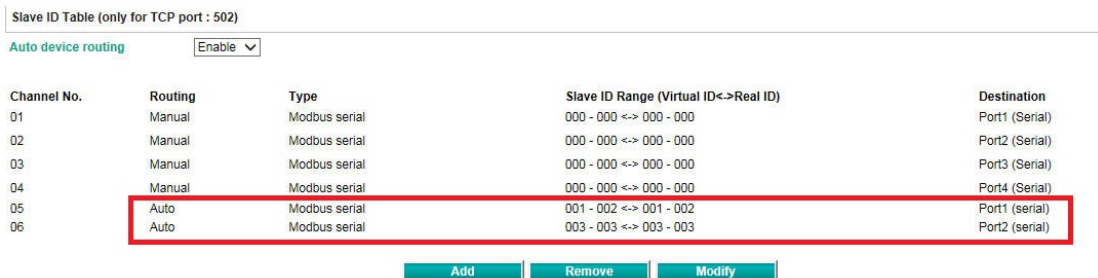

This snapshot shows the routing mechanism is in Auto mode, and the gateway detects that slave ID 1 and 2 are connected in port 1 and slave ID 3 is connected in port 2.

If a conflict exists, the table will show the error in red.

For example, two Modbus devices with the same slave ID are connected in serial port 1 and port 2.

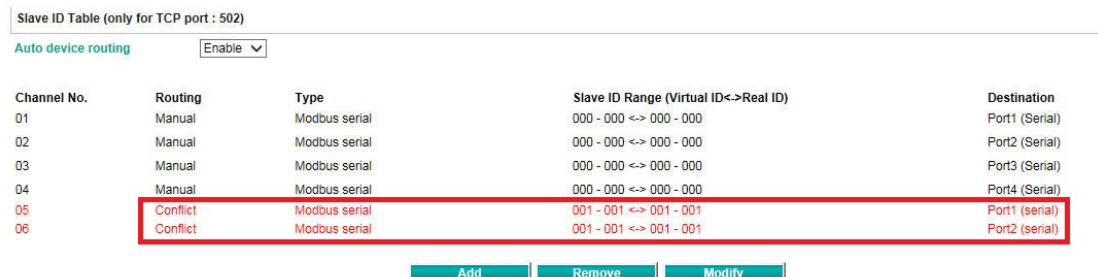

On the other hand, if you have manually set the routing table already, and you would like to enable the auto-routing mechanism for the newly added devices, click No to keep the existing routing table. The gateway will remain the existing user-set routing table and automatically route the newly devices. Note that if a newly added device cannot be polled by the Modbus master correctly, the slave ID of this newly added device might be set in the existing user-set table. Users have to modify the existing user-set table.

Another scenario is when legacy Modbus devices cannot set slave ID arbitrarily. It has a fixed slave ID or a short range of slave IDs. Then, the slave IDs of the Modbus devices connecting to different serial ports will be in conflict. The virtual-to-real slave ID function can help you to connect the same slave ID devices to different serial ports of a gateway.

Let's assume there are two legacy Modbus devices (named Device A, and Device B) with the same slave ID 1. Device A is connected to serial port 1 and Device B is connected to serial port 2. On the Modbus Master side, the Modbus request for Device A is recognized by slave ID 1 and the request for Device B is recognized by slave ID 2. You have to set the offset for the duplicate slave ID.

	Real Device ID	Virtual ID (Device ID recognized by Modbus Master)	Offset
Device A	1	1	0
Device B	1	2	-1

Original Setting

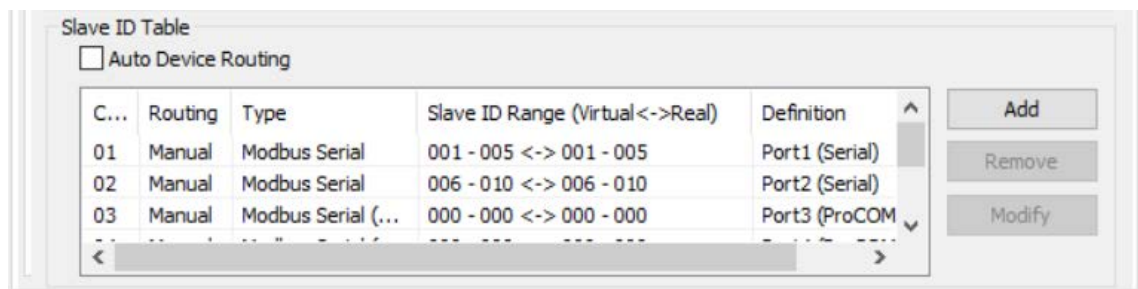

Select the first channel and click **Modify**. The Slave ID represents the Virtual ID recognized by the Modbus master.

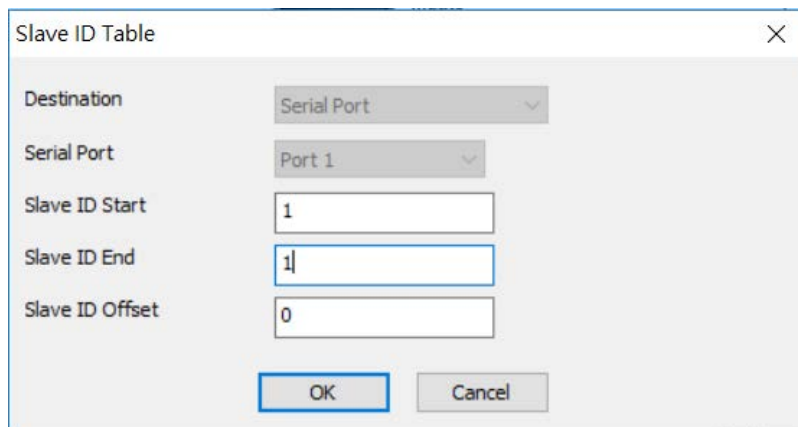

The routing table will show up as follows:

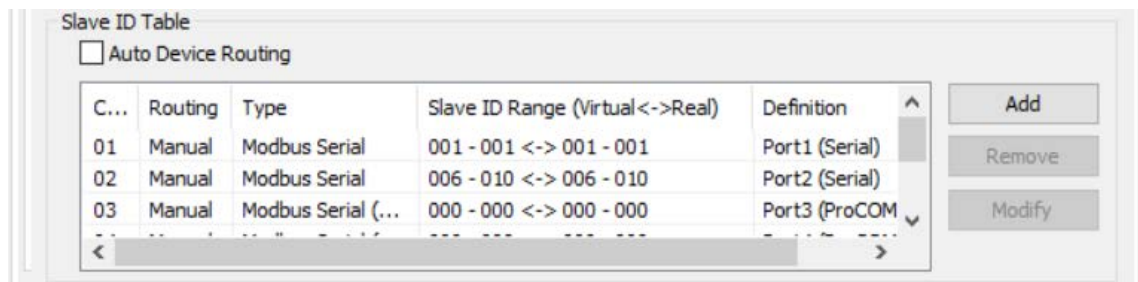

Select the second channel and click **Modify**. Since the virtual ID recognized by the Modbus master is 2, and the real slave ID of the device B is ID 1, the offset should be set as -1.

The dialog box 'Slave ID Table' has the following fields:

- Destination: Serial Port
- Serial Port: Port 2
- Slave ID Start: 2
- Slave ID End: 2
- Slave ID Offset: -1

Buttons: OK, Cancel

The routing table will show up as follows:

The routing table is as follows:

C...	Routing	Type	Slave ID Range (Virtual<->Real)	Definition
01	Manual	Modbus Serial	001 - 001 <-> 001 - 001	Port1 (Serial)
02	Manual	Modbus Serial	002 - 002 <-> 001 - 001	Port2 (Serial)
03	Manual	Modbus Serial (...)	000 - 000 <-> 000 - 000	Port3 (ProCOM)

Buttons: Add, Remove, Modify

Now, the Modbus master can send a request with slave ID 1 to Modbus device A connected to serial port 1 as well as send a request with slave ID 2 to the Modbus device B connected in serial port 2.

Priority Control

The Priority Control tab is where emergency requests are enabled and configured. This is available for advanced models only (MB3170, MB3170I, MB3270 and MB3270I).

The Priority Control window has the following sections:

- Specified Masters:**
 - Enable
 - Serial Port: 0
 - IP: 0 . 0 . 0 . 0
- Specified TCP Port:**
 - Enable
 - TCP Port: 7502 (1024 - 65535)
- Specified Requests:**
 - Enable
 - Slave ID: 1
 - Function Code: 3
 - Data (RTU Format in Hex):

Buttons: Add, Modify, Remove

Priority control is designed for requests that are sent to Modbus RTU/ASCII slaves. Since Modbus RTU/ASCII slaves cannot handle multiple requests, the Modbus gateway must send each request individually and wait for the response before sending the next request. As requests stack up, the response time can suffer. This can cause problems for certain critical requests that require an immediate response.

With priority control, you can specify that certain requests are sent to the front of the queue for more immediate response times. Priority requests can be specified by master (IP address or serial port), TCP port, or command type (slave ID, function code, or data). When the Modbus gateway identifies a priority request, the request will immediately be placed at the front of the queue.

To define a priority request, enable the appropriate priority scheme (i.e., **Specified Masters**, **Specified TCP Port**, or **Specified Requests**). Then, specify the parameter(s) that will indicate a priority request. Finally, click **Add/Modify** to apply this definition. (This last step is not necessary for **Specified TCP Port**.)

For example, if you want all requests from 192.168.32.161 to be considered a priority request, you would follow these steps:

1. Enable **Specified Masters**.
2. Enter 192.168.32.161 as the **IP**.
3. Click **Add/Modify**.

System Settings

Accessible IP

The MGate MB3000 uses an IP address-based filtering method to control access to itself.

The Accessible IP List function allows you to add or block remote host IP addresses to prevent unauthorized access. Access to the MGate MB3000 is controlled by IP address. That is, if a host's IP address is in the accessible IP table, then the host will be allowed to access the MGate MB3000. The different restrictions are listed in the table below (the checkbox **Apply additional restrictions** can only be activated if **Activate the accessible IP list** is activated).

Activate the accessible IP list	Apply additional restrictions	IPs on the list (Active checked)	IPs NOT on the list (Active NOT checked)
✓	–	All protocol communication and services* are allowed.	Protocol communication is not allowed, but services* are still allowed.
✓	✓	All protocol communication and services* are allowed.	All services* are not allowed.

*Services indicate HTTP, HTTPS, TELNET, SSL, SNMP, SMTP, DNS, NTP, DSU

You may add a specific address or range of addresses by using a combination of an IP address and a netmask as follows:

To allow access to a specific IP address: Enter the IP address in the corresponding field; enter 255.255.255.255 for the netmask.

To allow access to hosts on a specific subnet: For both the IP address and netmask, use 0 for the last digit (e.g., "192.168.1.0" and "255.255.255.0").

To allow access to all IP addresses: Make sure that **Enable** the accessible IP list is not checked.

Additional configuration examples are shown in the following table:

Desired IP Range	IP Address Field	Netmask Field
Any host	Disable	Enable
192.168.1.120	192.168.1.120	255.255.255.255
192.168.1.1 to 192.168.1.254	192.168.1.1	255.255.255.0
192.168.1.1 to 192.168.255.254	192.168.0.1	255.255.0.0
192.168.1.1 to 192.168.1.126	192.168.1.1	255.255.255.128
192.168.1.129 to 192.168.1.254	192.168.1.128	255.255.255.128

System Log

These settings enable the MGate firmware to record important events for future verification. The recorded information can only be displayed in the web console. **Please note that this feature is not supported on MB3180 gateway.**

The available information that can be recorded includes the following events:

Event Group	Description
System	System Cold Start, System Warm Start
Network	DHCP/BOOTP Get IP/Renew, NTP Connect Fail, IP Conflict, Network Link Down
Configuration	Login Fail, IP Changed, Password Changed, Firmware Upgrade, SSL Certificate Import, Configuration Import/Export

Local Log Settings	Description
Enable Log Capacity Warning (%)	The maximum number of log capacity is 1,000. When the log amount exceeds the warning percentage, it will trigger an event to SNMP Trap or Email
Warning by	SNMP Trap Email
Event log oversize action	Overwrites the oldest event log Stops recording event log

Syslog Settings	Description
Syslog server IP	IP address of the server that will record the log data
Syslog server Port	514

Users can view the recorded information from the web console or text mode console.

Auto Warning Settings

Auto Warning is triggered by different events. When a checked trigger condition occurs, the MGate can send e-mail alerts, SNMP Trap messages, or open/close the circuit of the relay output and trigger the Fault LED to start blinking. To enable an e-mail alert, configure the e-mail address on the **E-mail Alert** page. Likewise, to enable SNMP Trap alerts, configure SNMP trap server on the SNMP Trap page. **Please note that this feature is not supported on MB3180 gateway.**

The screenshot shows the 'Auto Warning' configuration page. It has a navigation bar with tabs: Basic, Network, Serial, Protocol, System, Accessible IP, System Log, Auto Warning (selected), E-mail Alert, SNMP Trap, SNMP Agent, Console Settings, and Notifica. The main content area is divided into two sections:

- System Event:**
 - Cold start: Mail, Trap
 - Warm start: Mail, Trap
 - Power input failure: Mail, Trap, Relay
 - Ethernet 1 link down: Mail, Trap, Relay
 - Ethernet 2 link down: Mail, Trap, Relay
- Config Event:**
 - Console(web/text) login auth failed: Mail, Trap
 - IP changed: Mail
 - Password changed: Mail

E-mail Alert

Along with activating "Mail" function from events on **Auto Warning Settings** page, the E-mail alert should be setup then. **Please note that this feature is not supported on MB3180 gateway.**

Parameters	Description
Mail server	The mail server's domain name or IP address.
Username	This field is for your mail server's user name, if required.
Password	This field is for your mail server's password, if required.
From e-mail address	This is the e-mail address from which automatic e-mail warnings will be sent.
To e-mail address 1 to 4	This is the e-mail address or addresses

SNMP Trap

Along with activating the **Trap** function from events on the **Auto Warning Settings** page, the SNMP Trap should be set up. **Please note that this feature is not supported on the MB3180 gateway.**

Parameters	Description
SNMP trap server IP	Use this field to indicate the IP address to use for receiving SNMP traps.
Trap version	Use this field to select the SNMP trap version.
Trap community	Use this field to designate the SNMP trap community.

SNMP Agent

The SNMP Agent is a network-management for collecting and organizing information about managed devices on IP network and for modifying the information on the device.

Parameters	Description
SNMP	To enable the SNMP Agent function, select the Enable option, and enter a community name (e.g., public).
Contact name	The optional SNMP contact information usually includes an emergency contact name and telephone number.
Read community string	This is a text password mechanism that is used to weakly authenticate queries to agents of managed network devices.
Write community string	This is a text password mechanism that is used to weakly authenticate changes to agents of managed network devices.
SNMP agent version	The MGate MB3000 Series supports SNMP V1, V2c, and V3.

Read-only and Read/write access control

While selecting SNMP agent version V3, it is needed to configure read-only and read/write access control parameters. The following fields allow you to define usernames, passwords, and authentication parameters for two levels of access: read-only and read/write. The name of the field will indicate which level of access it refers to. For example, **Read-only** authentication mode allows you to configure the authentication mode for read-only access, whereas **Read/write** authentication mode allows you to configure the authentication mode for read/write access. For each level of access, you may configure the following:

Parameters	Description
Username	Use this optional field to identify the username for the specified level of access.
Authentication mode	Use this field to select MD5 or SHA as the method of password encryption for the specified level of access, or to disable authentication.
Privacy mode	Use this field to enable or disable DES_CBC data encryption for the specified level of access.
Password	Use this field to set the password for the specified level of access.
Privacy	Use this field to define the encryption key for the specified level of access.

Console Settings

In order to support various security level, console and session can be further configured.

Configuration	Value	Description
HTTP/HTTPS	Enable/Disable	This setting is to enable/disable the web console. For security issues, users can only enable the HTTPS or just disable all settings.
Telnet	Enable/Disable	The MGate Telnet function can be enabled or disabled.
Reset button protect	Disable after 60 sec, Always enable	The MGate provides the reset button to clear the password or load factory default settings. But for security issues, users can disable this function. In disabled mode, the MGate will still enable this function within 60 seconds after boot-up, just in case users really need to reset this function.
Moxa command	Enable/Disable	The MGate can be searched by the DSU. If you have any security concerns, you can choose Disable to deny the DSU right to access.

Notification Message

The login message and login authentication failure message can be configured.

Account Management

A group of accessible accounts with two different user levels can be managed.

Account Name	Group
admin	admin

Buttons: Add, Edit, Delete

Parameters	Value	Description
Account Name		Users can set up the account name for login purpose.
Group	Admin, user	Users can change the password for different accounts. The MGate provides two different user levels: admin and user with maximum 16 accounts. The admin account can access and modify all the settings through the web console. The user account can only view the settings and cannot change anything.

Login Password Policy

Considering security level, the login password policy and failure lockout can be configured.

Account Password Policy

Minimum length: (4 - 16)

Enable password complexity strength check

- At least one digit(0~9)
- Mixed upper and lower case letters(A~Z, a~z)
- At least one special character:
~!@#%&^*_-_|:;.,<>[]{}()

Password lifetime: (90 - 180 days)

Account Login Failure Lockout

Enable

Retry failure threshold: (1 - 10 time)

Lockout time: (1 - 60 min)

Account Password Policy	Value	Description
Minimum length	4-16	
Enable password complexity strength check		Select how the MGate checks the password strength
Password lifetime	90-180 days	Set the password lifetime period

Account Login Failure Logout	Value	Description
Retry failure threshold	1-10 time(s)	
Lockout time	1-60 min	

Certificate

For the MGate self-signed certificate:

When we encounter the valid date of the certificate expired, we can regenerate the "MGate self-signed" certificate through the following steps.

- Step 1:** Users should delete the SSL certificate file originated from the MGate device.
- Step 2:** Then, enable the NTP server by setting up the time zone and local time.
- Step 3:** After restarting the device, the "MGate self-signed" certificate will be regenerated with the updated valid time.

For importing the third-party trusted SSL certificate:

By importing the third-party trusted SSL certificate, the security level can be enhanced. A snapshot of the GUI for the web console is shown below. To generate the SSL certificate through the third party, here are the steps:

- Step 1:** Step1: Create a certification authority (Root CA), such as Microsoft AD Certificate Service (<https://mizitechinfo.wordpress.com/2014/07/19/step-by-step-installing-certificate-authority-on-windows-server-2012-r2/>)
- Step 2:** Step 2: Find a tool to issue a "Certificate Signing Requests" file, where you can find it from third-party CA companies, such as DigiCert (<https://www.digicert.com/easy-csr/openssl.htm>).
- Step 3:** Step3: Submit it to a public certification authority for signing the certificate.
- Step 4:** Step4. Import the certificate to the MGate Series. Please note that the MGate Series only accepts "xxxx.pem" format.



NOTE

The maximum key length of the MGate devices supports 2,048 bits.

Some well-known third-party CA (Certificate Authority) companies are listed below for your reference: (https://en.wikipedia.org/wiki/Certificate_authority):

- IdenTrust (<https://www.identrust.com/>)
- DigiCert (<https://www.digicert.com/>)
- Comodo Cybersecurity (<https://www.comodo.com/>)
- GoDaddy (<https://www.godaddy.com/>)
- Verisign (<https://www.verisign.com/>)

Certificate

Certificate Settings

Issued to	10.144.8.226
Issued by	10.144.8.226
Valid	from 2000/3/4 to 2020/3/4
Select SSL certificate file	<input type="button" value="Choose File"/> No file chosen <input type="button" value="Import"/>
Delete SSL certificate file	<input type="button" value="Delete"/>

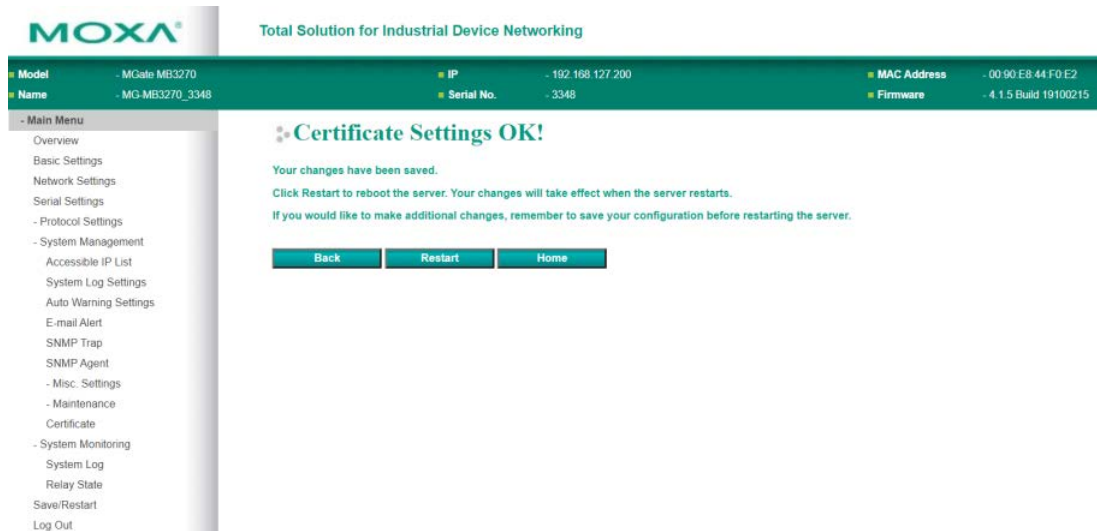

Verifying the Location of the Unit

If you are managing multiple MGate units, you may wonder if you are configuring the correct unit in MGate Manager. You can select a unit in MGate Manager and click **Locate** to make the unit's **Ready** LED blink for a few seconds. This will tell you which physical unit corresponds with the unit that you have selected.

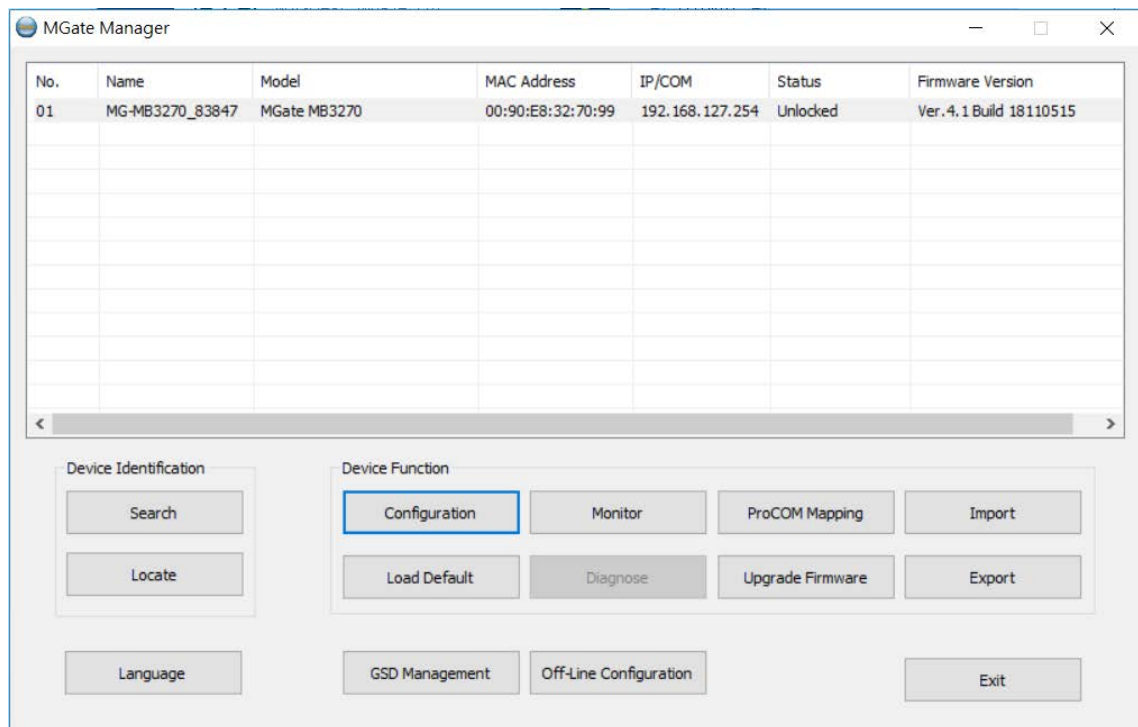

Monitoring Modbus Activity

For troubleshooting or management purposes, you can monitor the data passing through any MGate MB3000 on the network. Data events will be logged as they pass through the gateway. Rather than simply echoing the data, MGate Manager presents the data in an intelligent, easily-understood format, with clearly designated fields including source, type, destination, contents, and more. Events can be filtered in different ways, and the complete log can be saved to a file for later analysis.

Open Traffic Monitor Window

Select the unit that you wish to monitor and click **Monitor** to open the Traffic Monitor window.

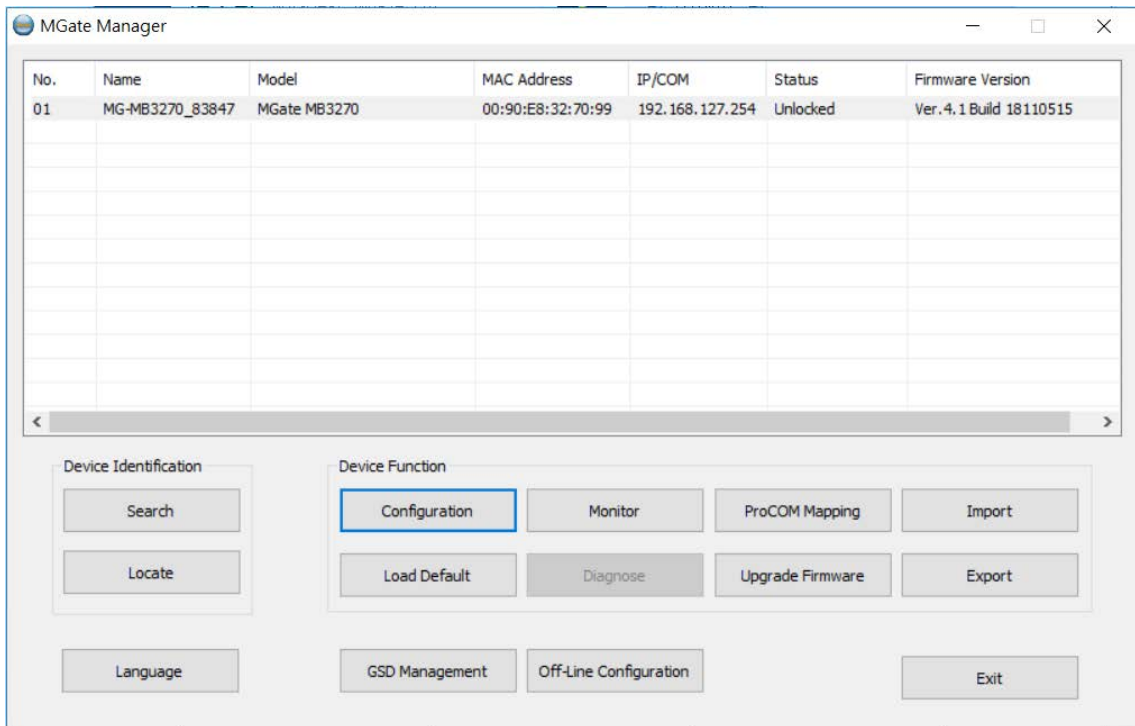

In the Traffic Monitor window, click **Start** to begin live monitoring of the data passing through the selected MGate MB3000 unit.

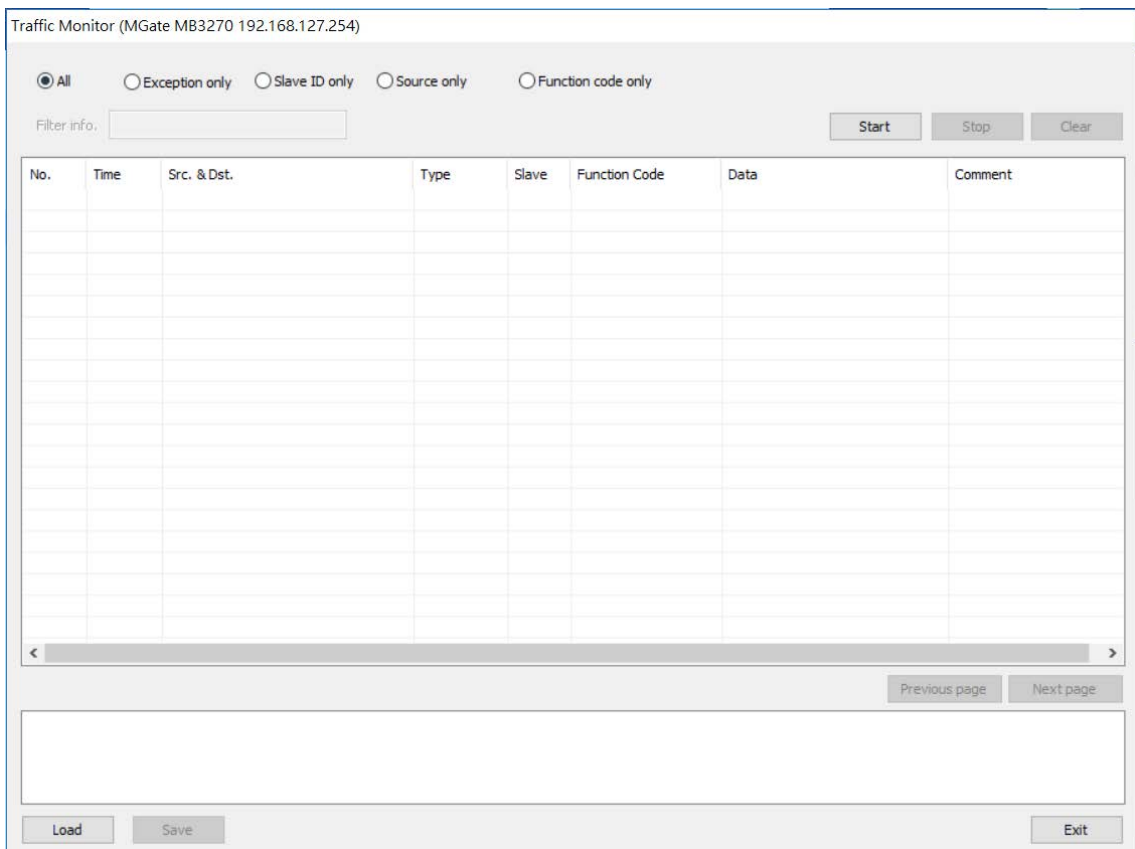

Traffic Monitor (MGate MB3270 192.168.127.254)

All
 Exception only
 Slave ID only
 Source only
 Function code only

Filter info:

Start Stop Clear

No.	Time	Src. & Dst.	Type	Slave...	Function Code	Data	Comment
1	0.000	192.168.33.26:59083<-	TCP Req.	1	0x01	B6 01 00 00 00 06 01 01 00 63 0...	Read coils
2	0.000	Port1->	RTU Req.	1	0x01	01 01 00 53 00 64 CD FF	Read coils
3	0.025	Port1<-	RTU Resp.	1	0x01	01 01 00 00 00 00 00 00 00 ...	Read coils
4	0.025	192.168.33.26:59083->	TCP Resp.	1	0x01	B6 01 00 00 00 10 01 01 00 00 ...	Read coils
5	0.035	192.168.33.26:59083<-	TCP Req.	1	0x01	B7 01 00 00 00 06 01 01 00 63 0...	Read coils
6	0.035	Port1->	RTU Req.	1	0x01	01 01 00 53 00 64 CD FF	Read coils
7	0.055	Port1<-	RTU Resp.	1	0x01	01 01 00 00 00 00 00 00 00 ...	Read coils
8	0.055	192.168.33.26:59083->	TCP Resp.	1	0x01	B7 01 00 00 00 10 01 01 00 00 ...	Read coils
9	0.050	192.168.33.26:59083<-	TCP Req.	1	0x01	B8 01 00 00 00 06 01 01 00 63 0...	Read coils
10	0.050	Port1->	RTU Req.	1	0x01	01 01 00 53 00 64 CD FF	Read coils
11	0.095	Port1<-	RTU Resp.	1	0x01	01 01 00 00 00 00 00 00 00 ...	Read coils
12	0.095	192.168.33.26:59083->	TCP Resp.	1	0x01	B8 01 00 00 00 10 01 01 00 00 ...	Read coils
13	0.110	192.168.33.26:59083<-	TCP Req.	1	0x01	B9 01 00 00 00 06 01 01 00 63 0...	Read coils
14	0.110	Port1->	RTU Req.	1	0x01	01 01 00 53 00 64 CD FF	Read coils
15	0.130	Port1<-	RTU Resp.	1	0x01	01 01 00 00 00 00 00 00 00 ...	Read coils
16	0.130	192.168.33.26:59083->	TCP Resp.	1	0x01	B9 01 00 00 00 10 01 01 00 00 ...	Read coils
17	0.135	192.168.33.26:59083<-	TCP Req.	1	0x01	BA 01 00 00 00 06 01 01 00 63 ...	Read coils
18	0.135	Port1->	RTU Req.	1	0x01	01 01 00 53 00 64 CD FF	Read coils
19	0.150	Port1<-	RTU Resp.	1	0x01	01 01 00 00 00 00 00 00 00 ...	Read coils
20	0.150	192.168.33.26:59083->	TCP Resp.	1	0x01	BA 01 00 00 00 10 01 01 00 00 ...	Read coils
21	0.170	192.168.33.26:59083<-	TCP Req.	1	0x01	BB 01 00 00 00 06 01 01 00 63 0...	Read coils

Previous page Next page

Load Save Exit

To stop capturing the log, press the **Stop** button.

Traffic Monitor (MGate MB3270 192.168.127.254)

All
 Exception only
 Slave ID only
 Source only
 Function code only

Filter info:

Start Stop Clear

No.	Time	Src. & Dst.	Type	Slave...	Function Code	Data	Comment
1	0.000	192.168.33.26:59083<-	TCP Req.	1	0x01	B6 01 00 00 00 06 01 01 00 63 0...	Read coils
2	0.000	Port1->	RTU Req.	1	0x01	01 01 00 53 00 64 CD FF	Read coils
3	0.025	Port1<-	RTU Resp.	1	0x01	01 01 00 00 00 00 00 00 00 ...	Read coils
4	0.025	192.168.33.26:59083->	TCP Resp.	1	0x01	B6 01 00 00 00 10 01 01 00 00 ...	Read coils
5	0.035	192.168.33.26:59083<-	TCP Req.	1	0x01	B7 01 00 00 00 06 01 01 00 63 0...	Read coils
6	0.035	Port1->	RTU Req.	1	0x01	01 01 00 53 00 64 CD FF	Read coils
7	0.055	Port1<-	RTU Resp.	1	0x01	01 01 00 00 00 00 00 00 00 ...	Read coils
8	0.055	192.168.33.26:59083->	TCP Resp.	1	0x01	B7 01 00 00 00 10 01 01 00 00 ...	Read coils
9	0.050	192.168.33.26:59083<-	TCP Req.	1	0x01	B8 01 00 00 00 06 01 01 00 63 0...	Read coils
10	0.050	Port1->	RTU Req.	1	0x01	01 01 00 53 00 64 CD FF	Read coils
11	0.095	Port1<-	RTU Resp.	1	0x01	01 01 00 00 00 00 00 00 00 ...	Read coils
12	0.095	192.168.33.26:59083->	TCP Resp.	1	0x01	B8 01 00 00 00 10 01 01 00 00 ...	Read coils
13	0.110	192.168.33.26:59083<-	TCP Req.	1	0x01	B9 01 00 00 00 06 01 01 00 63 0...	Read coils
14	0.110	Port1->	RTU Req.	1	0x01	01 01 00 53 00 64 CD FF	Read coils
15	0.130	Port1<-	RTU Resp.	1	0x01	01 01 00 00 00 00 00 00 00 ...	Read coils
16	0.130	192.168.33.26:59083->	TCP Resp.	1	0x01	B9 01 00 00 00 10 01 01 00 00 ...	Read coils
17	0.135	192.168.33.26:59083<-	TCP Req.	1	0x01	BA 01 00 00 00 06 01 01 00 63 ...	Read coils
18	0.135	Port1->	RTU Req.	1	0x01	01 01 00 53 00 64 CD FF	Read coils
19	0.150	Port1<-	RTU Resp.	1	0x01	01 01 00 00 00 00 00 00 00 ...	Read coils
20	0.150	192.168.33.26:59083->	TCP Resp.	1	0x01	BA 01 00 00 00 10 01 01 00 00 ...	Read coils
21	0.170	192.168.33.26:59083<-	TCP Req.	1	0x01	BB 01 00 00 00 06 01 01 00 63 0...	Read coils

Previous page Next page

Load Save Exit

Filter Traffic Information

By default, all events are displayed in the traffic monitor window. MGate Manager also allows the data to be filtered so only the relevant information is displayed. The filter is selected, using the radio buttons, and customized, using the **Filter info** field, as follows:

Filter	Customization	Description
All	–	Show all traffic
Exception only	–	Show only exceptions
SID only	VSID=< virtual slave ID> (e.g., "VSID=1")	Show only traffic to and from the specified "virtual" slave ID (as assigned in the MGate's slave ID table)
	RSID=< actual slave ID> (e.g., "RSID=1")	Show only traffic to and from the specified "actual" slave ID (as assigned on the device itself)
Source only	IP=<IP address> (e.g., "IP=192.168.1.2")	Show only traffic sent from the specified IP address
	PORT=< MGate serial port number> (e.g., "PORT=1")	Show only traffic sent from the specific serial port on the MGate
Function code only	FCODE=<Modbus function code> (e.g., "FCODE=3")	Show only traffic for a specific function code

Save Log to File

To save the data log to a file, click **Save**. You may retrieve a saved log by clicking **Load**. You can select the location to save the data log as well as the file format, such as .log or .csv file.

The screenshot shows the Traffic Monitor window for MGate MB3270 at IP 192.168.127.254. At the top, there are radio buttons for filtering: All (selected), Exception only, Slave ID only, Source only, and Function code only. Below these is a 'Filter info' text box and 'Start', 'Stop', and 'Clear' buttons. The main area is a table with columns: No., Time, Src. & Dst., Type, Slave..., Function Code, Data, and Comment. The table contains 21 rows of traffic data. At the bottom, there are 'Previous page' and 'Next page' buttons, and a large empty text area. At the very bottom, there are three buttons: 'Load', 'Save', and 'Exit'. The 'Load' and 'Save' buttons are circled in red in the original image.

After clicking **Save**, a window pops-up where you can select the location to save the log file.

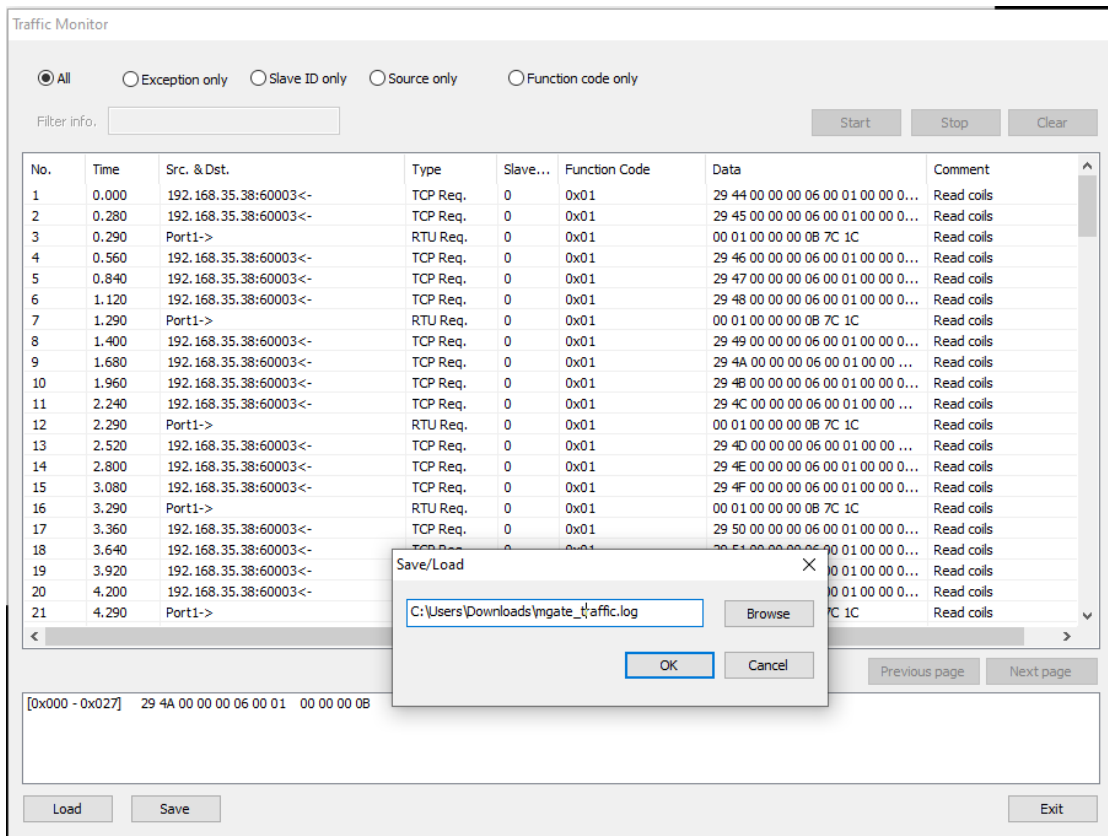

To save the file to .csv format, click **Browse** and select the drop-down menu to choose .csv format.

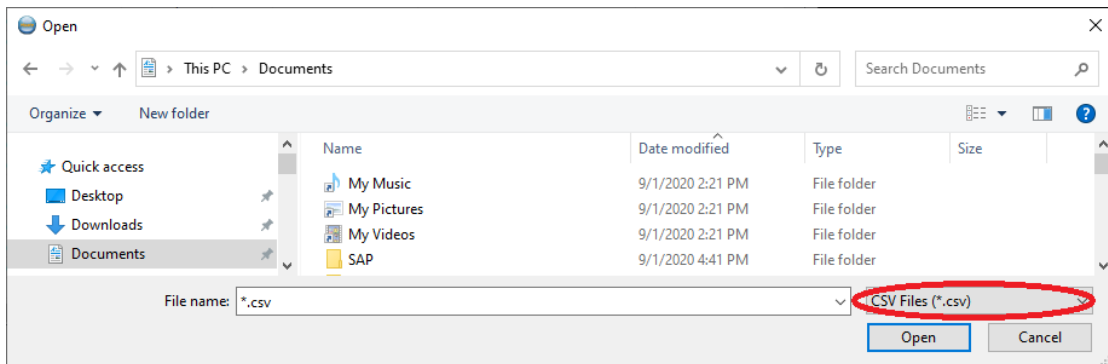

ProCOM Mapping

If your system uses remote PCs that only support COM port behavior to control remote Modbus devices, then ProCOM is the best solution for your system. Before using ProCOM, your PC needs to create virtual COM ports that connect to a specific ProCOM over an Ethernet network. By using ProCOM, the MGate MB3x70 will treat your PC's COM port as if it were an additional serial port on the MGate MB3x70.

Configuring ProCOM

To enable this function, ProCOM mapping must be completed as follows:

Locate the MGate MB3x70 with the search function, select the MGate MB3x70 device that you want to set ProCOM for, and then click **ProCOM Mapping** to enter the mapping dialog box, as illustrated by the following figures.

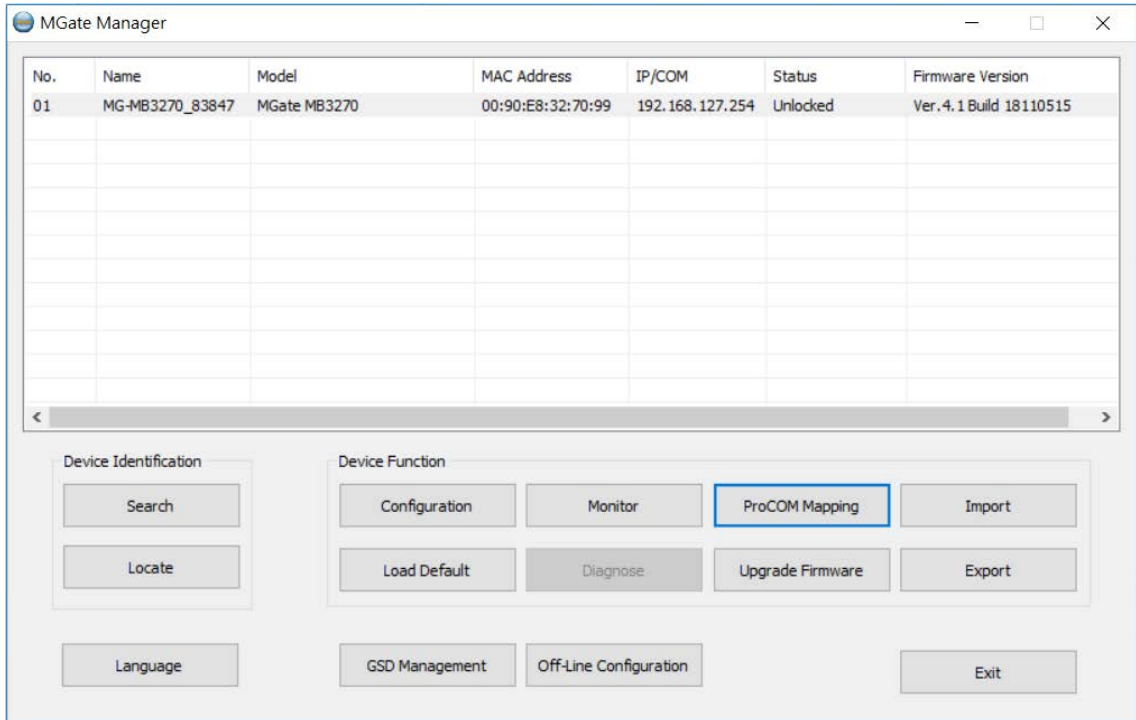

On the ProCOM mapping dialog box, you can map up to four ProCOM functions for each Modbus gateway to your PC's COM ports. The driver will generate virtual COM ports on your PC to connect to the selected MGate MB3x70 over the network.

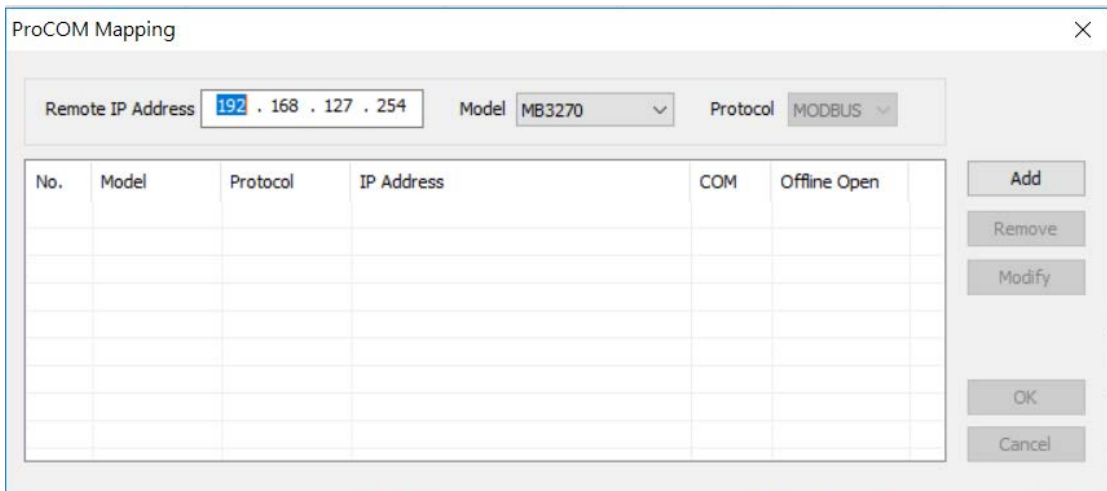

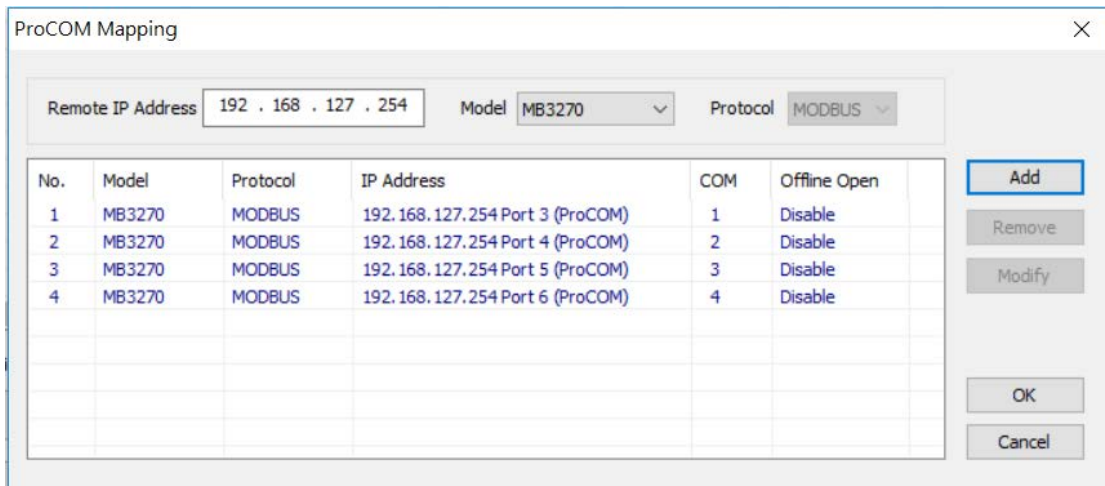

This way, when you send a Modbus request to ProCOM, the driver will forward your request to the MGate MB3x70 and the MGate MB3x70 will forward the request to the target Modbus device using the preset Modbus device mode and Slave ID. For example, the Modbus request from ProCOM can be redirected to a Modbus RTU/ASCII device that is behind the MGate MB3x70's serial interface or to a Modbus TCP device through the MGate MB3x70's Ethernet port. In addition, it can be redirected to another ProCOM port on the MGate MB3x70.

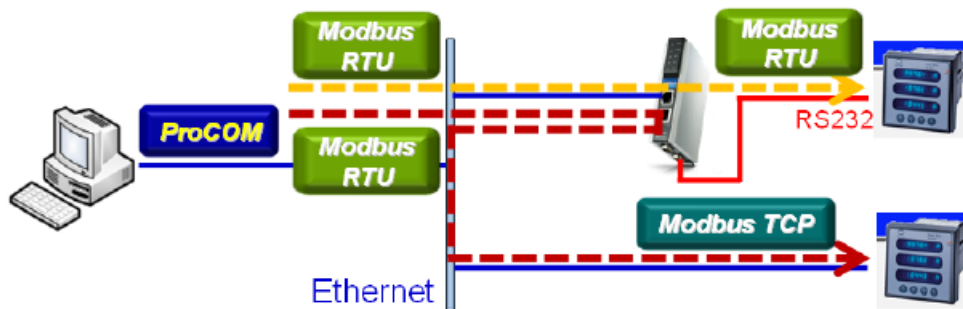

If you would like to change the COM port numbers, double-click on the items as follows:

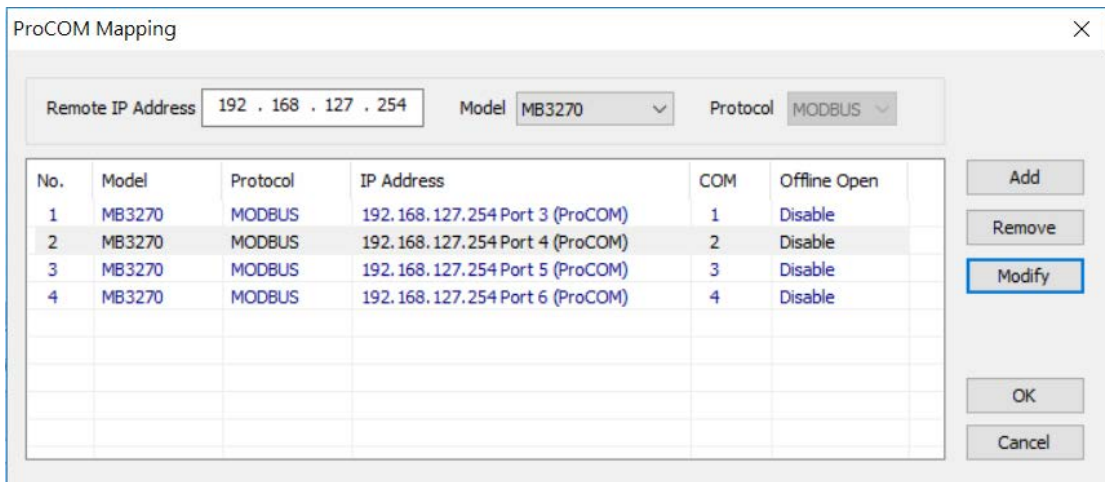

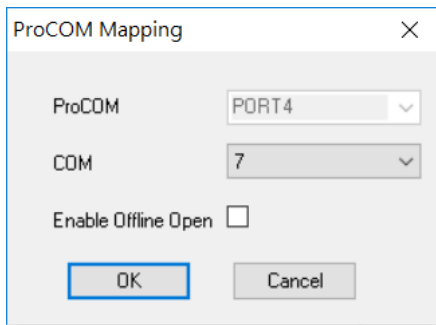

Once finishing configuring the COM port, click **OK** and check if the COM port is changed successfully.

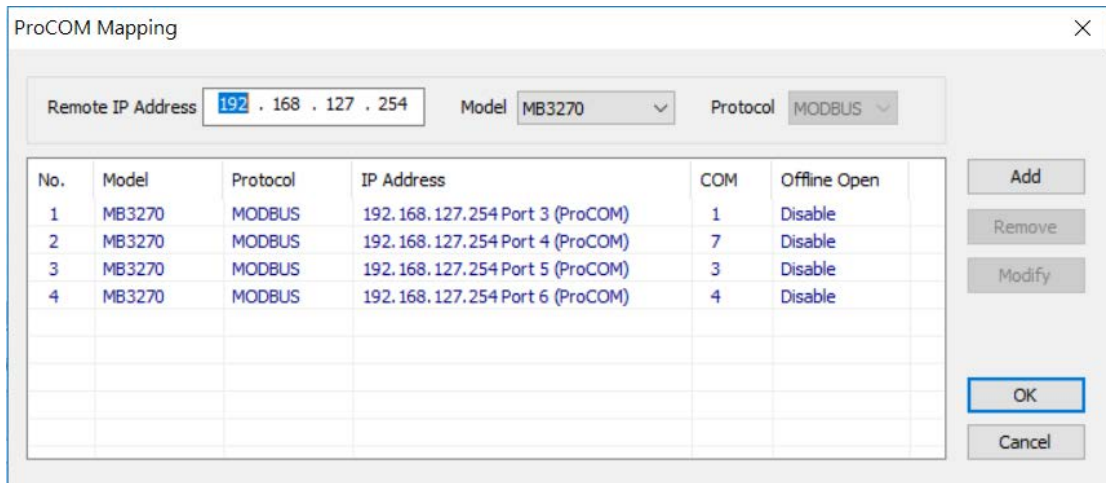

Offline Open

This function enables users to open ProCOM port(s) before the device is connected. In this case, the data transmitted to ProCOM port(s) will be kept temporarily and will be sent out once the ProCOM port(s) are ready for access.

Select the **Enable Offline Open** checkbox and click **OK** to enable this function.

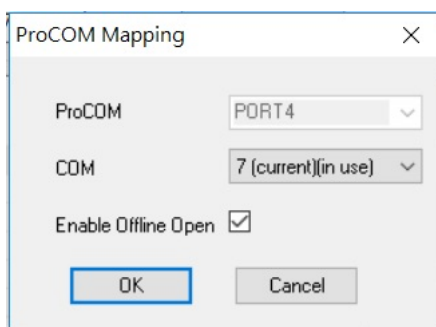

The Offline Open function is changed successfully from the mapping table.

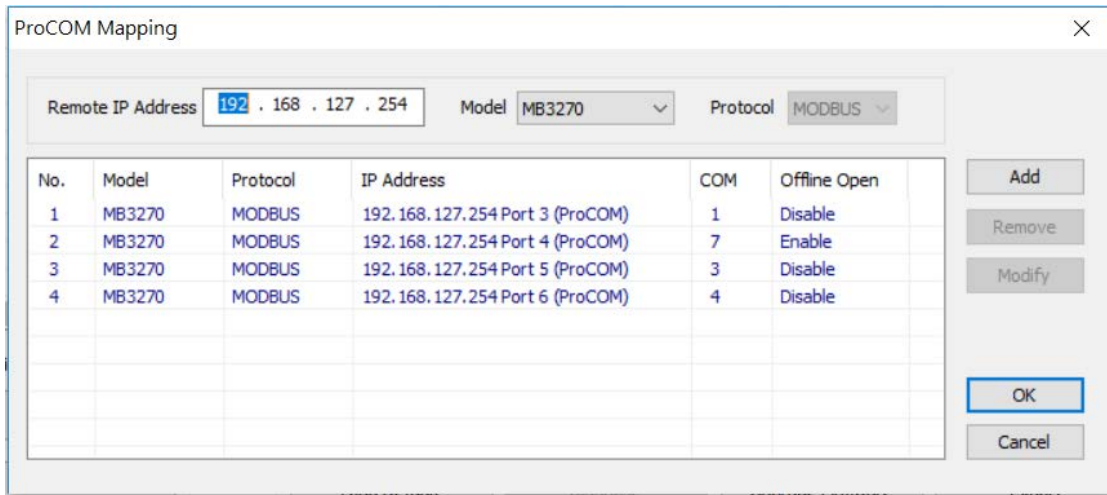

Upgrading Firmware

The updated MGate MB3000 Series firmware is located at <http://www.moxa.com>. After you have downloaded the new firmware onto your PC, you can use MGate Manager to write it onto your MGate MB3000 gateway. Select the desired unit from the list in MGate Manager and click **Upgrade Firmware** to begin the process.

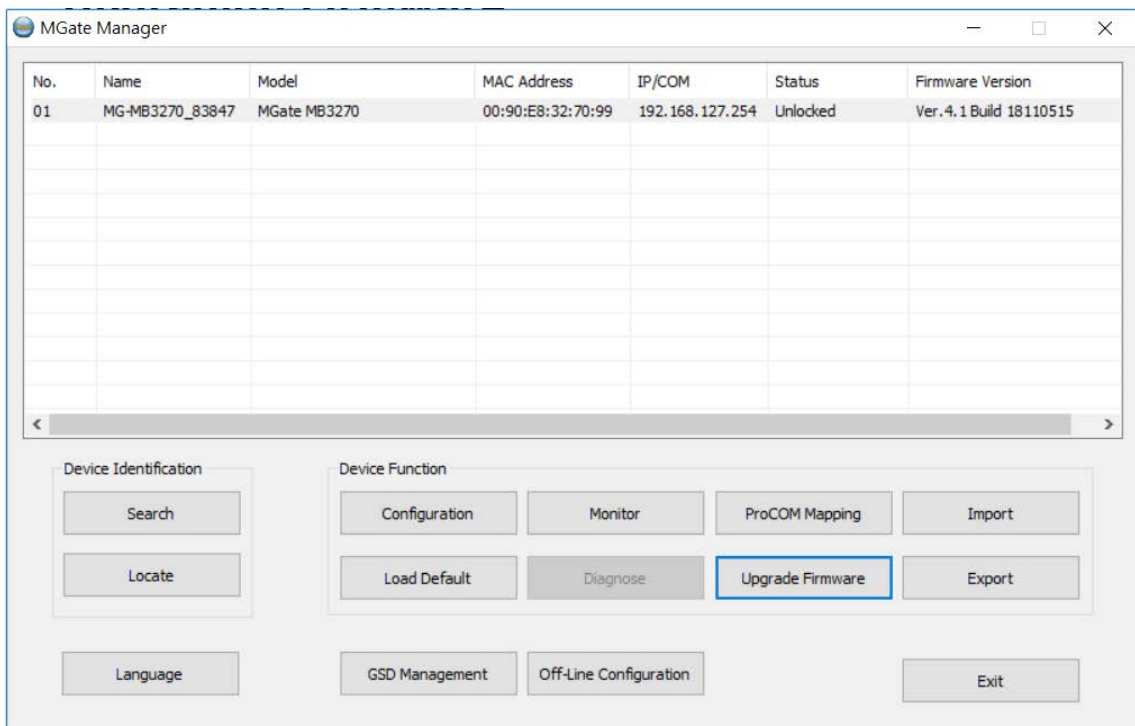

The dialog boxes will guide you through the process. You will need to browse your PC for the firmware file. Make sure that it matches your model.

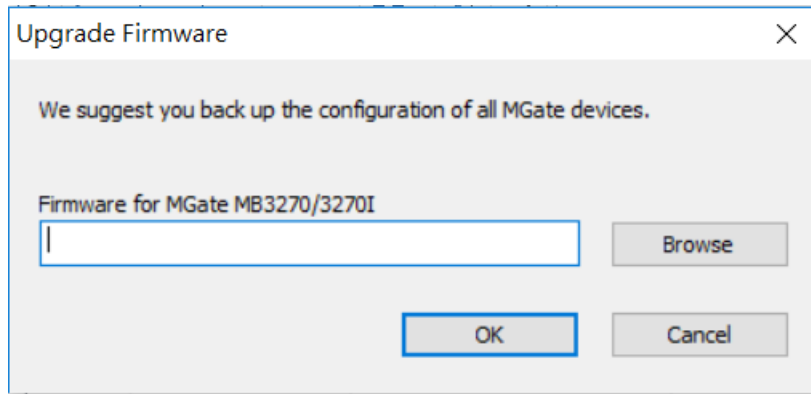

As the firmware is written to the unit, progress is displayed in the window.

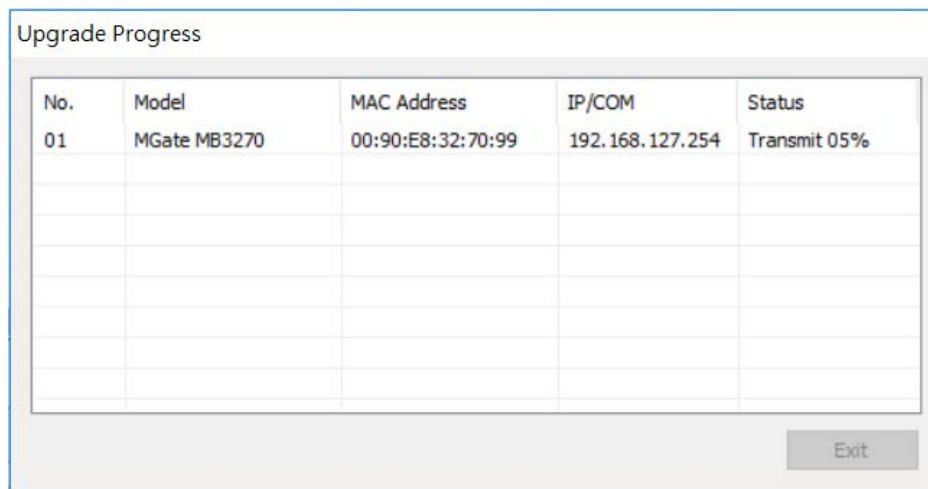

ATTENTION

DO NOT turn off the MGate's power before the firmware upgrade process is completed. The MGate will be erasing the old firmware to make room for the new firmware to flash memory. If you power off the MGate and terminate the progress, the flash memory will contain corrupted firmware and the MGate will fail to boot. If this happens, call Moxa RMA services.

Once the firmware has been successfully written onto the unit where the status is shown as **OK**, then click **Exit** to close the Upgrade Firmware window. MGate Manager will automatically execute a Broadcast Search for all MGate MB3000 units on the LAN. Your MGate should reappear in the list of units.



ATTENTION

While executing firmware upgrade, it is recommended to back up the configuration file by using **Export** function. Once the latest firmware is successfully written onto the unit, it is recommended to reset the device to default by using **Load Default** function.

Load Default

To clear all the settings on the unit, use the **Load Default** button to reset the unit to its initial factory default values.

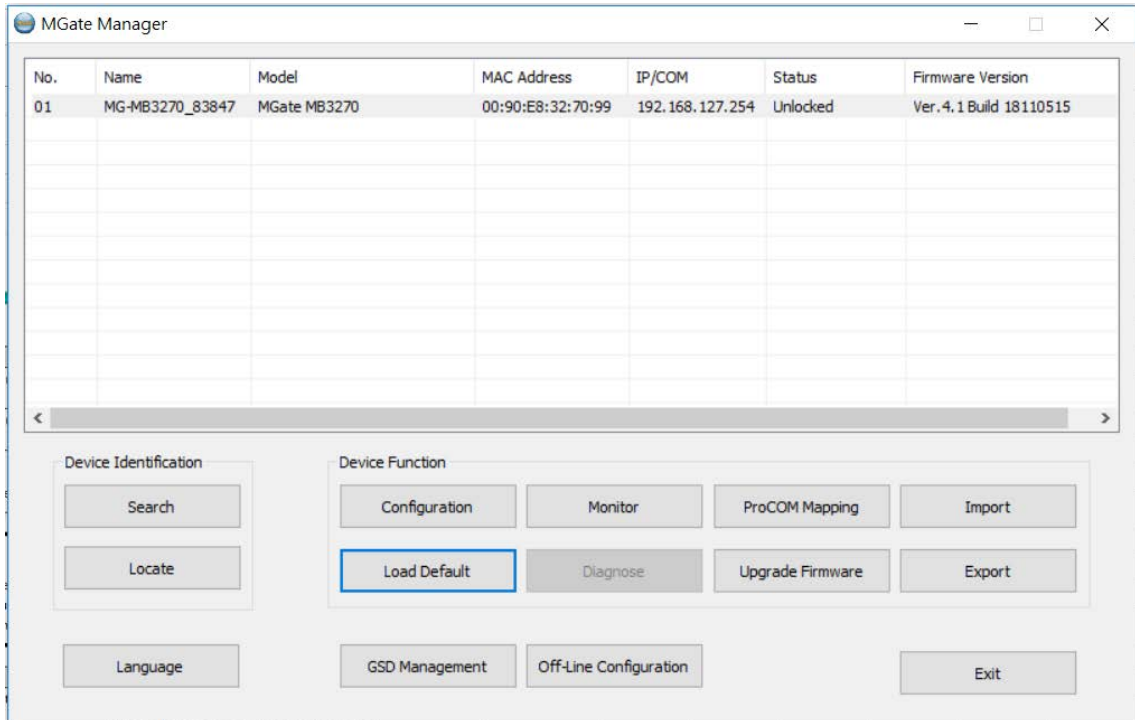

Click **Load Default** and review the confirmation message. If you are sure you would like to reset the configuration to factory defaults, click the **OK** button. If not, click **Cancel**.

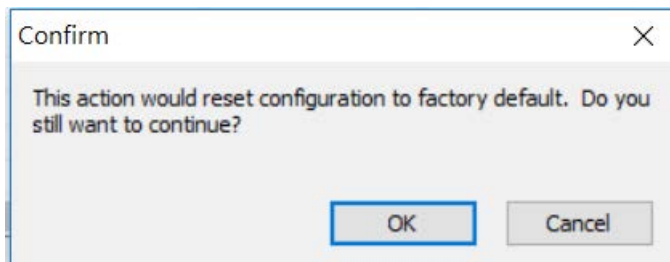

After the MGate Manager resets completely, MGate Manager will automatically execute a Broadcast Search for all MGate units on the LAN. Your MGate should reappear in the list of units.



ATTENTION

Load Default will completely reset the configuration of the unit, and all of the parameters you have saved will be discarded. Do not use this function unless you are sure you want to completely reset your unit.

Export/Import

There are three main reasons for using the Import and Export functions.

- **Applying the same configuration to multiple units**
The Import/Export configuration function is a convenient way to apply the same settings to units located in different sites. You can export the configuration as a file and then import the configuration file onto other units at any time.
- **Backing up configurations for system recovery**
The export function allows youStep1: Create a certUsers should delete the SSL certificate file originated from the MGate device.
- **Troubleshooting**
Exported configuration files can help administrators to identify system problems that provide useful information for Moxa's Technical Service Team when maintenance visits are requested.

Export Function

The export function saves all the configuration settings and parameters of the MGate MB3000 Series in a *.cfg file. To begin, click the **Export** button.

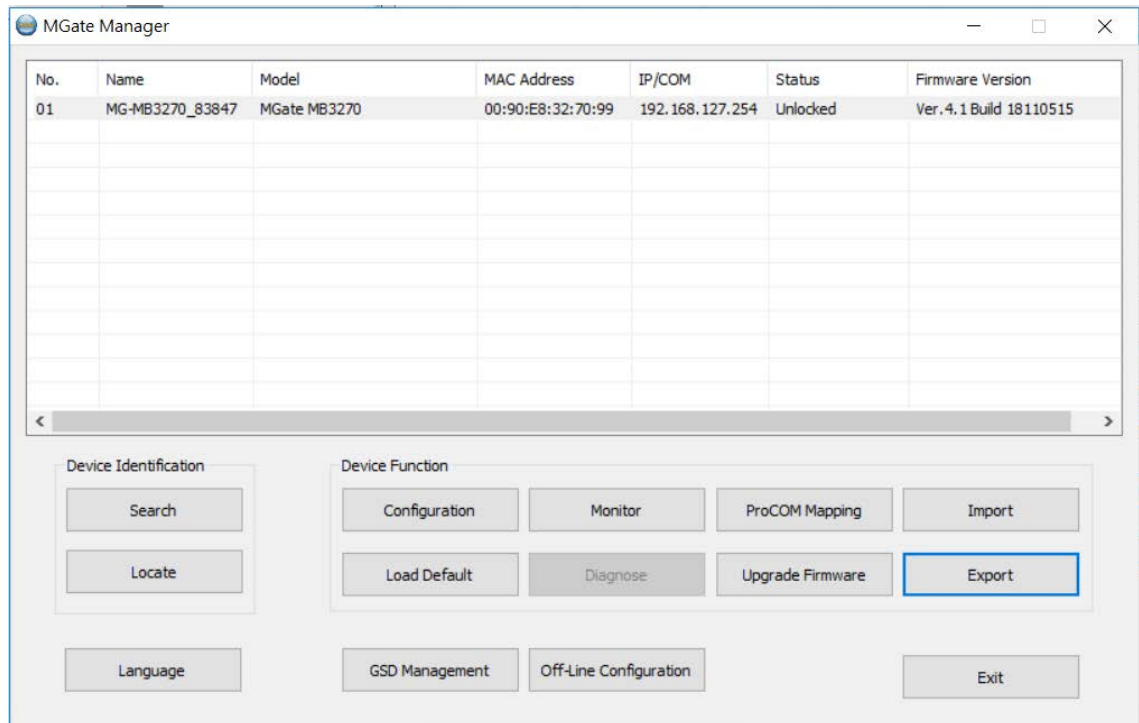

Enter a file name and use the **Browse** button to save the file to a specific path. Then, click the **OK** button.

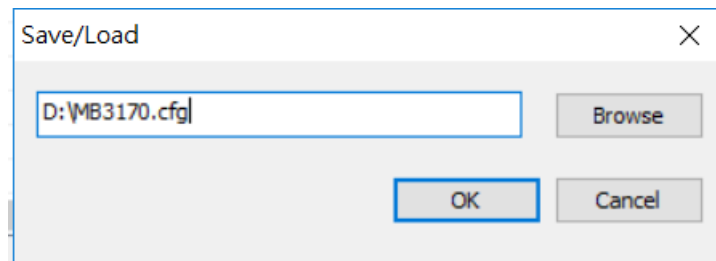

If you export the configuration file successfully, a confirmation message will pop up and the configuration file will be saved as a *.cfg file

Import Function

Once the file is saved, it can be imported into your target unit to duplicate the same settings. Select the target unit first and click the **Import** button to import.

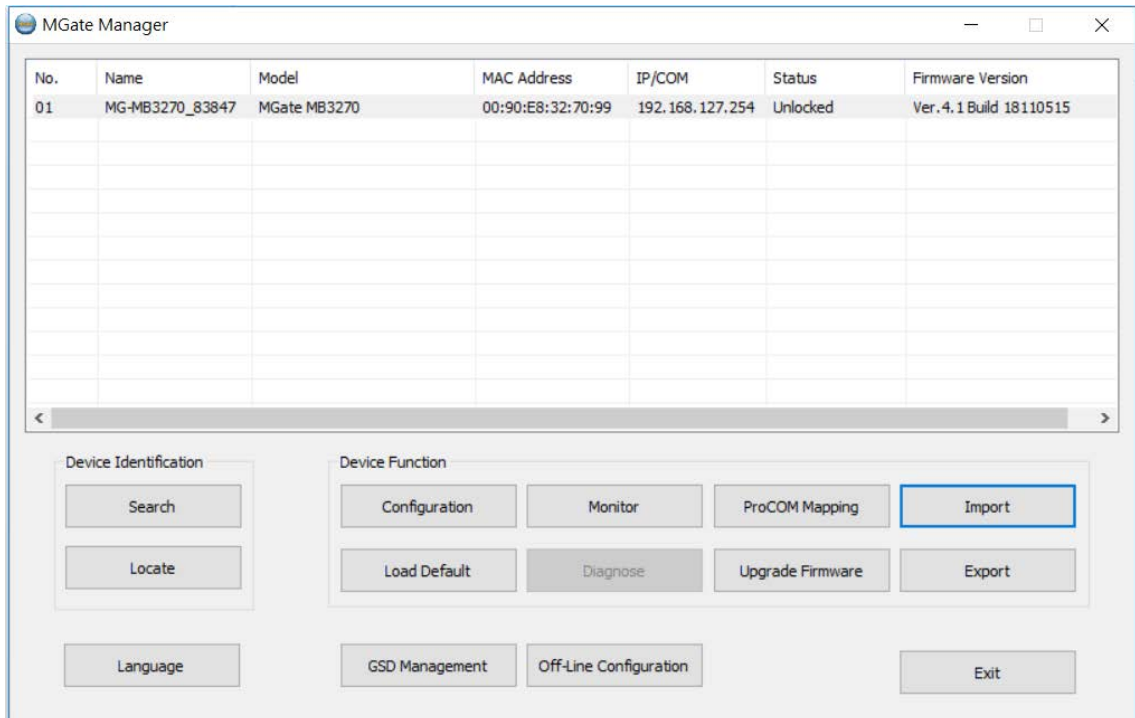

Select the file you want to import, and then click the **OK** button

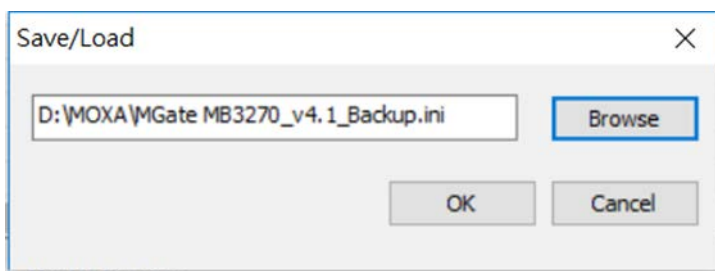

Wait for the MGate Manager to finish configuring the target device. If you import the configuration file successfully, a confirmation message will pop up. After closing the message dialog, the MGate Manager will automatically execute a Broadcast Search for all MGate units on the LAN. Your MGate should reappear in the list of units.



ATTENTION

DO NOT turn off the MGate power before the firmware upgrade process is completed. The MGate will be erasing the old firmware to make room for the new firmware to flash memory. If you power off the MGate and terminate the process, all settings will disappear, and the MGate gateway will revert to factory defaults. If this happens, import the settings from the file again.

MXview

The Moxa MXview network management software gives you a convenient graphical representation of your Ethernet network and allows you to configure, monitor, and diagnose Moxa networking devices. MXview provides an integrated management platform that can manage the Moxa MGate MB3000 Series as well as Ethernet switches and wireless APs, and SNMP-enabled and ICMP-enabled devices installed on subnets. MXview includes an integrated MIB compiler that supports any third-party MIB. It also allows you to monitor third-party OIDs and Traps. Network and Trap components that have been located by MXview can be managed via web browsers from both local and remote sites—anytime, anywhere.

Additionally, the Moxa MXview supports the Security View function to follow Moxa's security guidelines, which are based on current IEC 62243 component-level recommendations. Security View checks the security level of Moxa's network devices, including the MGate MB3000 Series.

All MGate MB3000 devices can be recognized by MXview. However, be sure your MGate device has the proper firmware version installed, as listed in the following table:

Model type	Firmware version
MGate MB3170/3170I	2.1 or higher
MGate MB3270/3270I	2.1 or higher
MGate MB3180	1.3 or higher
MGate MB3280	2.1 or higher
MGate MB3480	2.1 or higher

Before adding MGate MB3000 devices to the MXview utility, you must add the MB3000 plug-in package to MXview via Plug-in Manager. The Plug-in Manager is automatically installed when setting up MXview. Please execute **Plug-in Manager** and **add** the plug-in package. You can download the plug-in package at <http://www.moxa.com>.

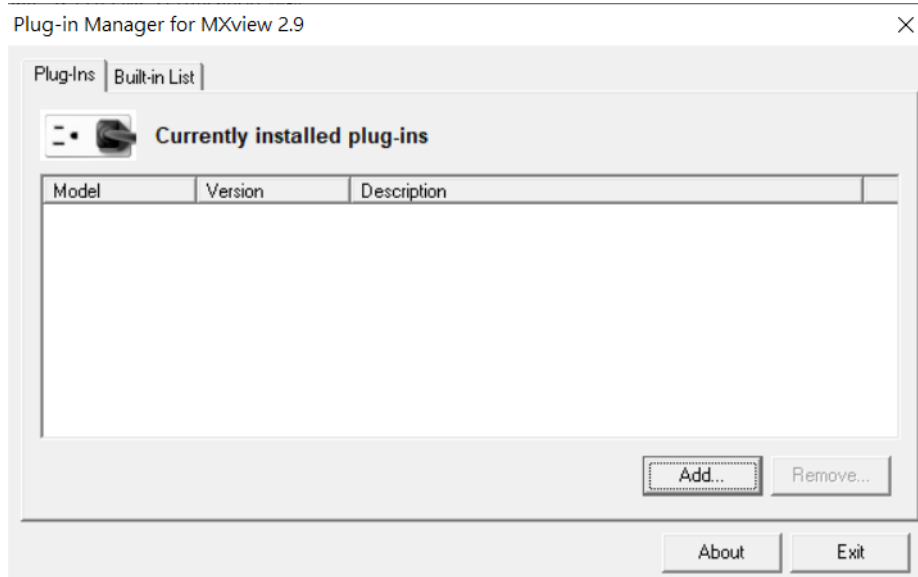
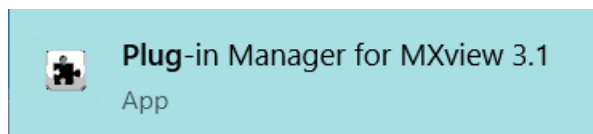

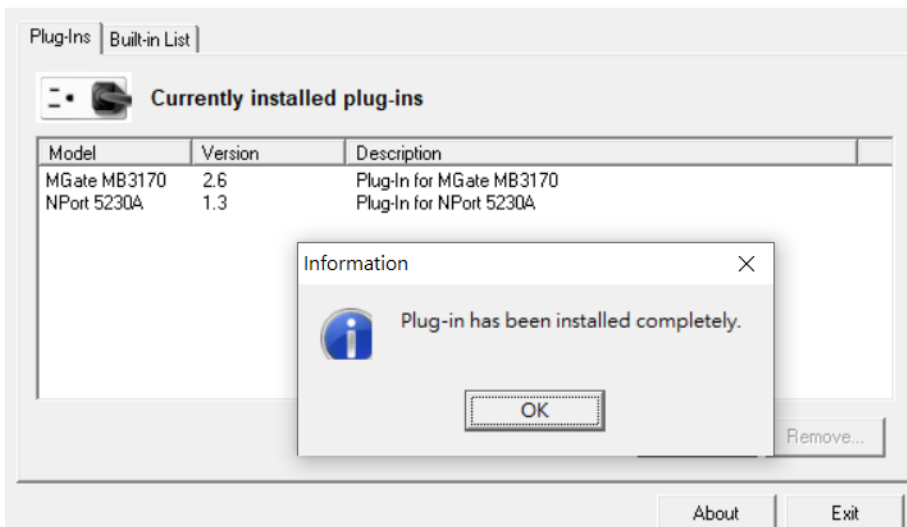
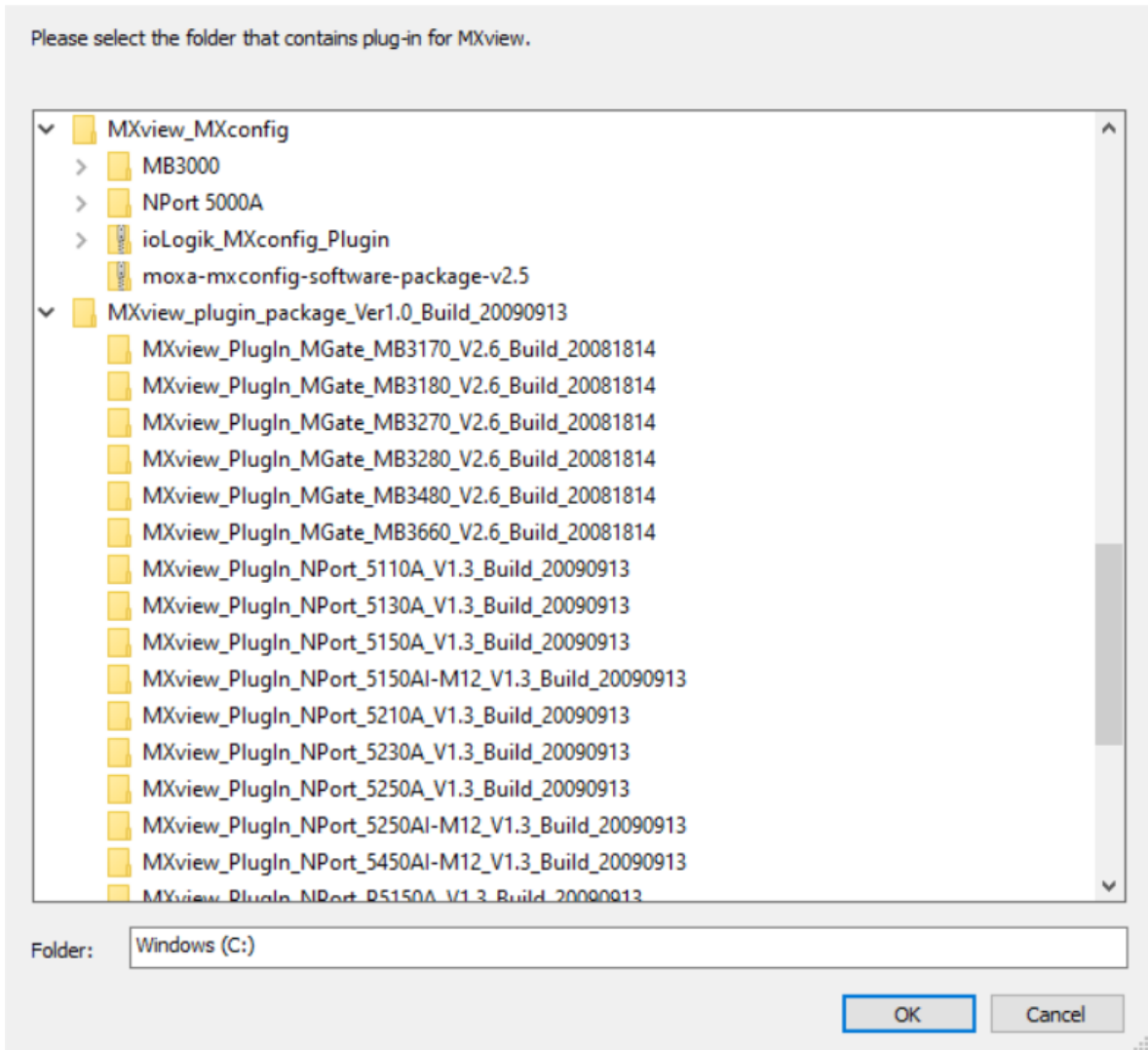

MXconfig

Moxa's MXconfig is a comprehensive Windows-based utility that is used to install, configure, and maintain multiple Moxa devices in industrial networks. This suite of useful tools helps users set the IP addresses of multiple devices with one click, configure the redundant protocols and VLAN settings, modify multiple network configurations of multiple Moxa devices, upload firmware to multiple devices, export/import configuration files, copy configuration settings across devices, easily link to web and telnet consoles, and test device connectivity. MXconfig gives device installers and control engineers a powerful and easy way to mass configure devices, and effectively reduces the setup and maintenance cost.

Through MXconfig, users can access the MGate MB3000 devices and take advantage of additional functions, such as searching for MGate MB3000 devices, setting network configurations, upgrading firmware, and importing/exporting configurations.

Before configuring MGate MB3000 devices via MXconfig utility, you must add the MB3000 plug-in package to MXconfig. You can download the plug-in package in the product page and execute plug-in package with just a few clicks.

MXconfig_plugin_package_setup_Ver1.0_Build_20090815	9/8/2020 3:53 PM	Application	1,290 KB
Version	9/8/2020 3:51 PM	Text Document	3 KB

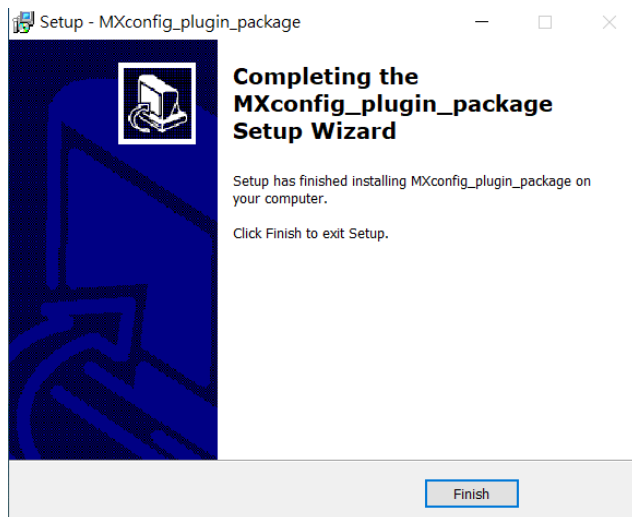
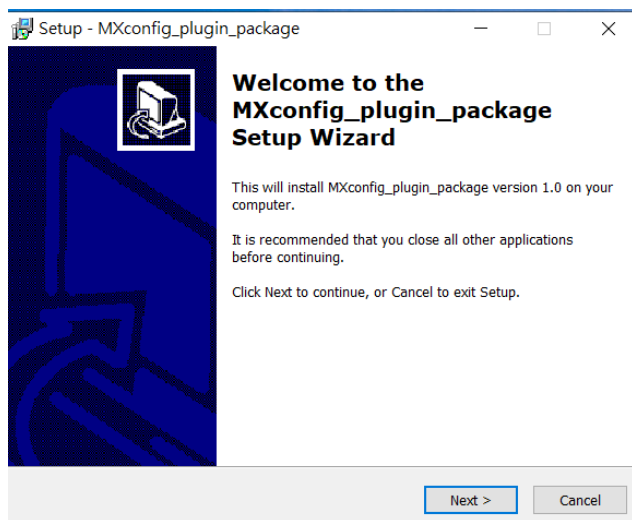

For more detailed information regarding MXview/MXconfig, download the user manual from Moxa's website at <http://www.moxa.com>

11. Case Studies

Introduction

There are many reasons a Modbus gateway might be used to integrate Modbus networks. However, every situation has its own requirements and difficulties. Users may wonder how the gateway can help or even if the gateway is suitable for the system.

This chapter presents some case studies to guide you. If you can not find a case similar to yours, it does not mean the MGate MB3000 is not suitable for you. Please contact Moxa, and we will work it out with you.

Replace Serial Masters with Ethernet Master(s), Slave IDs are Configurable

In this scenario, the original control system consists of several serial-based systems. In each system, a serial master directly controls serial slave devices, as follows:

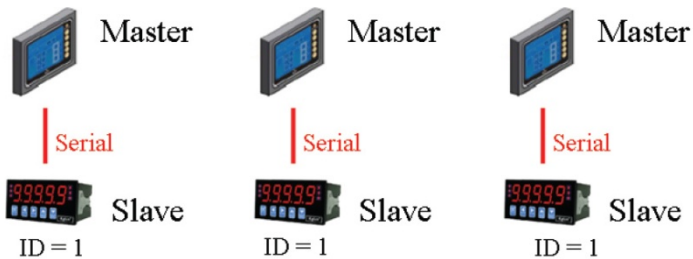

The MGate MB3000 can connect to each serial slave, so Ethernet SCADA masters will be able to control them. However, since slave IDs cannot be repeated in a system, we will need to change the IDs of some of the slaves in order to integrate them into a single network, as follows:

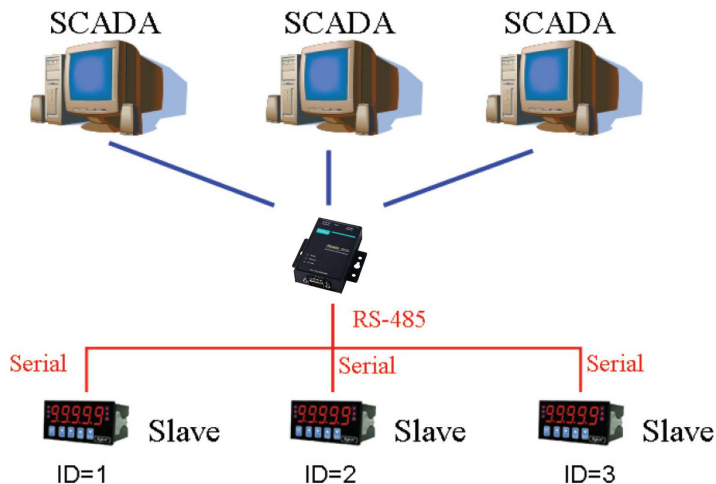

Replace Serial Masters with Ethernet Master(s), Slave IDs are Fixed

Some legacy Modbus slave devices have fixed IDs that cannot be changed. In order to integrate the devices into a Modbus TCP network, a multiport MGate model (MB3280, MB3270, or MB3480) can be used to assign virtual slave IDs. For more information about virtual slave IDs, please refer to Chapter 9.

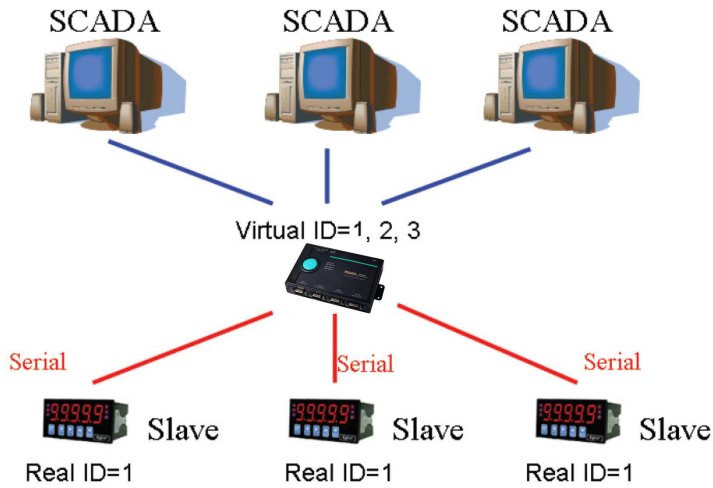

Keep Serial Master and Add Ethernet Master(s)

In this scenario, the serial control system is a direct, low-latency system. The serial master must not be replaced, but Ethernet masters will need to have access to the serial slaves for monitoring or supervision.



Serial Redirector

An advanced multiport MGate model (MB3270/MB3270I) can be inserted into the serial system, with the slaves connected to one serial port and the master to another serial port. The advanced gateway allows Ethernet masters to communicate with the serial slaves, and it also provides a serial redirector function that simultaneously allows the serial master to continue controlling the slaves.

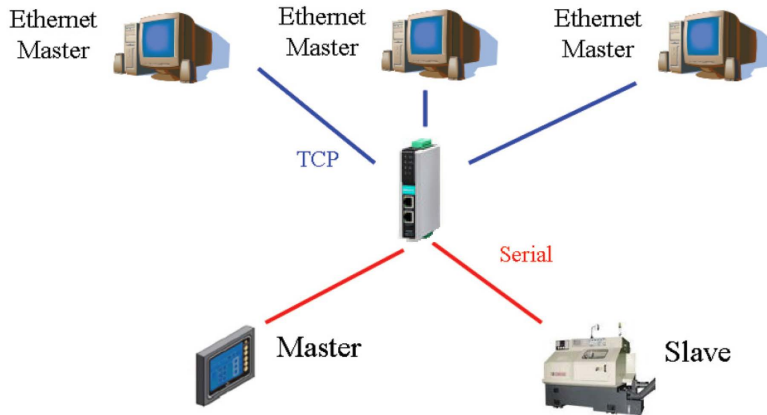

Integrate Modbus RTU, ASCII, and TCP at the Same Time

There can be a wide range in number, type, and sophistication of devices on the factory floor. The most common devices are simple serial-based meters, which report certain information relating to factory environment or equipment. However, other Modbus serial slaves may be as complex as a manufacturing machine or a PLC controller.

When integrating these devices, there may be issues if different serial environments are used for different devices. One system may use a different baudrate than another, or may use Modbus ASCII instead of Modbus RTU. The MGate MB3000 allows the different Modbus systems to be integrated into one network, regardless of the protocol or communication parameters.

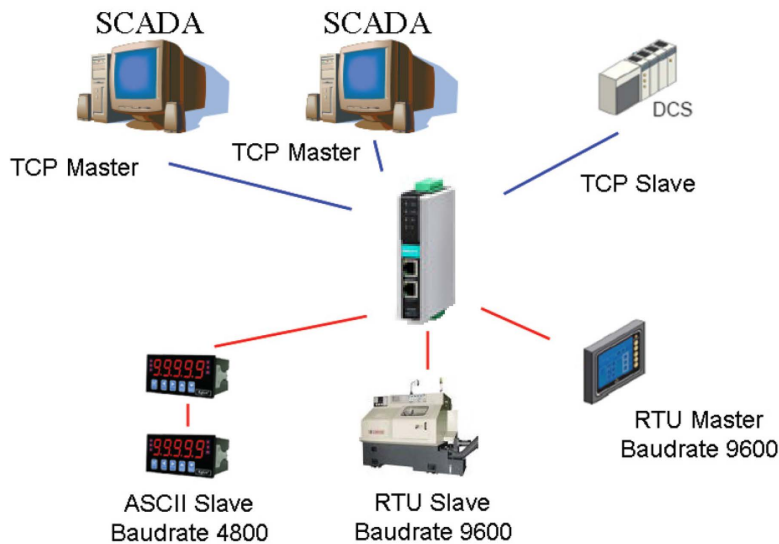

A. Modbus Overview

Introduction

Modbus is one of the most popular automation protocols in the world. It supports both serial and Ethernet devices. Many industrial devices, such as PLCs, DCSs, HMIs, instruments, meters, motors, and drivers, use Modbus as their communication standard.

Devices are Either Masters or Slaves

All Modbus devices are classified as either a master or a slave. Masters initiate all communication with slaves and do not communicate to other masters. Slaves are completely passive and communicate only by sending a response to a master's request.



Slaves are Identified by ID

Each Modbus slave in a system is assigned a unique ID between 1 and 247. Whenever a master makes a request, the request must include the ID of the intended recipient. Master devices themselves have no ID.

0	1 to 247	248 to 255
Broadcast address	Slave individual address	Reserved

Communication is by Request and Response

All Modbus communication is by request and response. A master sends a request and a slave sends a response. The master will wait for the slave's response before sending the next request. For broadcast commands, no response is expected. This is illustrated by three scenarios as follows:

Normal

The master sends a request to the slave. The slave sends a response with the requested information.

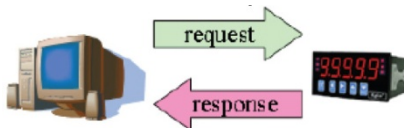

Exception

The master sends a request to the slave. The slave may not support the command or an error is detected, so it sends an exception to the master.

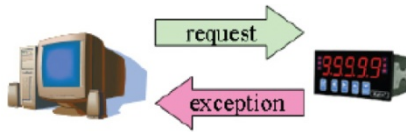

Broadcast

The master sends a broadcast command, such as a reset command. Every slave on the network complies with the command, and no response is sent to the master.



Requests Need a Time Limit

The original Modbus protocol was not designed for simultaneous requests or simultaneous masters, so only one request on the network can be handled at a time. When a master sends a request to a slave, no other communication may be initiated until after the slave responds. The Modbus protocol specifies that masters use a response time-out function to identify when a slave is nonresponsive due to device or line failure. This function allows a master to give up on a request if no response is received within a certain amount of time. This is illustrated as follows:

Response Time-Out

The master sends a request. The slave is unresponsive for the amount of time specified by the response time-out function. The master gives up on the request and resumes operation, allowing another request to be initiated.



To allow for a wide range of devices, baudrates, and line conditions, actual response time-out values are left open for manufacturers to determine. This allows the Modbus protocol to accommodate a wide range of devices and systems. However, this also makes it difficult for system integrators to know what response time-out value to use during configuration, especially with older or proprietary devices.

The MGate MB3000 provides a patent-protected function that tests all attached devices and recommends a response time-out value. This function saves considerable time and effort for system integrators, and it results in more accurate time-out settings.

Modbus Ethernet vs. Modbus Serial

Although Modbus is intended as an application-layer messaging protocol, the data format and communication rules for Ethernet-based Modbus TCP are different from serial-based Modbus ASCII and RTU.

The major difference between the Ethernet and serial Modbus protocols is the behavior of the communication model. Modbus ASCII and RTU allow only one request on the network at a time. Once a request is sent, no other communication on the bus is allowed until the slave sends a response, or until the request times out. However, Modbus TCP allows simultaneous requests on the network, from multiple masters to multiple slaves. TCP masters cannot send more than one request at a time to a slave, but they can send requests to other slaves before a response is received. The Modbus TCP standard recommends that slaves be able to queue up to 16 requests at a time. The MGate MB3000 will queue up to 32 requests from each TCP master, for up to 16 or 32 TCP masters.

Integrate Modbus Serial and Ethernet with Gateways

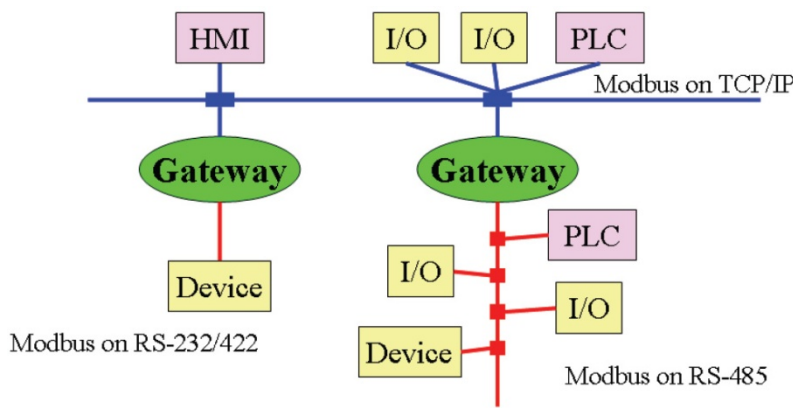

Ordinarily, Modbus TCP and Modbus ASCII/RTU are unable to communicate with each other. However, with a Modbus gateway in between the Modbus serial network and the Modbus Ethernet network, TCP masters are able to communicate with serial slaves, and serial masters are able to communicate with TCP slaves.

B. SNMP Agents with MIB II and RS-232-Like Groups

The MGate MB3000 Series has built-in Simple Network Management Protocol (SNMP) agent software that supports SNMP Trap, RFC1317 and RS-232-like groups, and RFC 1213 MIB-II.

RFC1213 MIB-II Supported SNMP Variables

System MIB	Interfaces MIB	IP MIB	ICMP MIB
sysDescr	ifNumber	ipForwarding	icmpInMsgs
sysObjectID	ifIndex	ipDefaultTTL	icmpInErrors
sysUpTime	ifDescr	ipInReceives	icmpInDestUnreachs
sysContact	ifType	ipInHdrErrors	icmpInTimeExcds
sysName	ifMtu	ipInAddrErrors	icmpInParmProbs
sysLocation	ifSpeed	ipForwDatagrams	icmpInSrcQuenchs
sysServices	ifPhysAddress	ipInUnknownProtos	icmpInRedirects
	ifAdminStatus	ipInDiscards	icmpInEchos
	ifOperStatus	ipInDelivers	icmpInEchoReps
	ifLastChange	ipOutRequests	icmpInTimestamps
	ifInOctets	ipOutDiscards	icmpTimestampReps
	ifInUcastPkts	ipOutNoRoutes	icmpInAddrMasks
	ifInNUcastPkts	ipReasmTimeout	icmpInAddrMaskReps
	ifInDiscards	ipReasmReqds	icmpOutMsgs
	ifInErrors	ipReasmOKs	icmpOutErrors
	ifInUnknownProtos	ipReasmFails	icmpOutDestUnreachs
	ifOutOctets	ipFragOKs	icmpOutTimeExcds
	ifOutUcastPkts	ipFragFails	icmpOutParmProbs
	ifOutNUcastPkts	ipFragCreates	icmpOutSrcQuenchs
	ifOutDiscards	ipAdEntAddr	icmpOutRedirects
	ifOutErrors	ipAdEntIfIndex	icmpOutEchos
	ifOutQLen	ipAdEntNetMask	icmpOutEchoReps
	ifSpecific	ipAdEntBcastAddr	icmpOutTimestamps
		ipAdEntReasmMaxSize	icmpOutTimestampReps
		ipRouteDest	icmpOutAddrMasks
		ipRouteIfIndex	icmpOutAddrMaskReps
		ipRouteMetric1	
		ipRouteMetric2	
		ipRouteMetric3	
		ipRouteMetric4	
		ipRouteNextHop	
		ipRouteType	
		ipRouteProto	
		ipRouteAge	
		ipRouteMask	
		ipRouteMetric5	
		ipRouteInfo	
		ipNetToMediaIfIndex	
		ipNetToMediaPhysAddress	
		ipNetToMediaNetAddress	
		ipNetToMediaType	
		ipRoutingDiscards	

Address Translation MIB	TCP MIB	UDP MIB	SNMP MIB
atIfIndex	tcpRtoAlgorithm	udpInDatagrams	snmpInPkts
atPhysAddress	tcpRtoMin	udpNoPorts	snmpOutPkts
atNetAddress	tcpRtoMax	udpInErrors	snmpInBadVersions
	tcpMaxConn	udpOutDatagrams	snmpInBadCommunityNames
	tcpActiveOpens	udpLocalAddress	snmpInBadCommunityUses
	tcpPassiveOpens	udpLocalPort	snmpInASNParseErrs
	tcpAttemptFails		snmpInTooBigs
	tcpEstabResets		snmpInNoSuchNames
	tcpCurrEstab		snmpInBadValues
	tcpInSegs		snmpInReadOnlys
	tcpOutSegs		snmpInGenErrs
	tcpRetransSegs		snmpInTotalReqVars
	tcpConnState		snmpInTotalSetVars
	tcpConnLocalAddress		snmpInGetRequests
	tcpConnLocalPort		snmpInGetNexts
	tcpConnRemAddress		snmpInSetRequests
	tcpConnRemPort		snmpInGetResponses
	tcpInErrs		snmpInTraps
	tcpOutRsts		snmpOutTooBigs
			snmpOutNoSuchNames
			snmpOutBadValues
			snmpOutGenErrs
			snmpOutGetRequests
			snmpOutGetNexts
			snmpOutSetRequests
			snmpOutGetResponses
			snmpOutTraps
			snmpEnableAuthenTraps
			snmpSilentDrops
			snmpProxyDrops

RFC1317 RS-232-Like Groups

RS-232 MIB	Async Port MIB
rs232Number	rs232AsyncPortIndex
rs232PortIndex	rs232AsyncPortBits
rs232PortType	rs232AsyncPortStopBits
rs232PortInSigNumber	rs232AsyncPortParity
rs232PortOutSigNumber	
rs232PortInSpeed	
rs232PortOutSpeed	

Input Signal MIB	Output Signal MIB
rs232InSigPortIndex	rs232OutSigPortIndex
rs232InSigName	rs232OutSigName
rs232InSigState	rs232OutSigState