

# MAT-WDB-CA-RM-2-0205 系列

MIMO 2x2、2.4/5 GHz、雙頻天花板天線：2/5 dBi，RP-SMA-type (公)



## 特色與優點

- RP-SMA-type (公) 連接器
- 輕量
- 便於安裝在天花板上
- -40°C 至 75°C 操作溫度範圍

## 簡介

MAT-WDB-CA-RM-2-0205 天線是輕巧 MIMO 2x2 雙頻天花板天線，配備 RP-SMA-type (公) 連接器。此天線可用於 2.4 GHz 和 5 GHz 頻率，可在 -40 至 75°C 的溫度下操作。

## 現場方向圖

連接埠 1 頻率：2.4 GHz

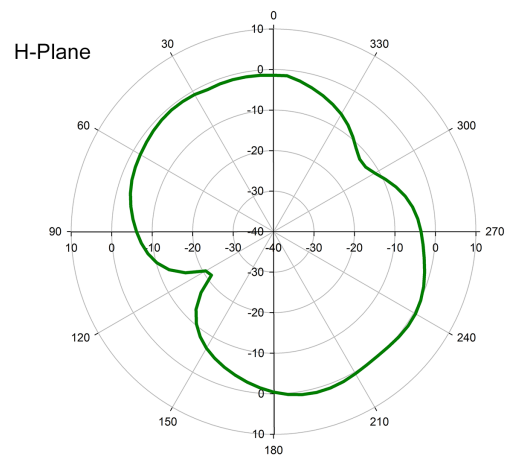
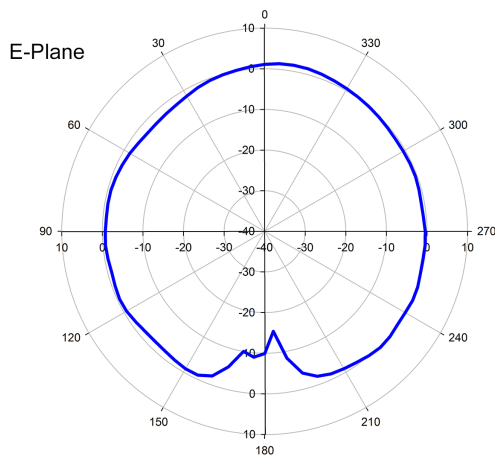

## 連接埠 2 頻率 : 2.4 GHz

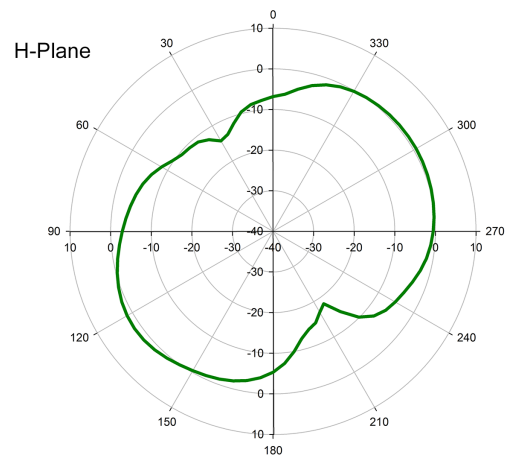
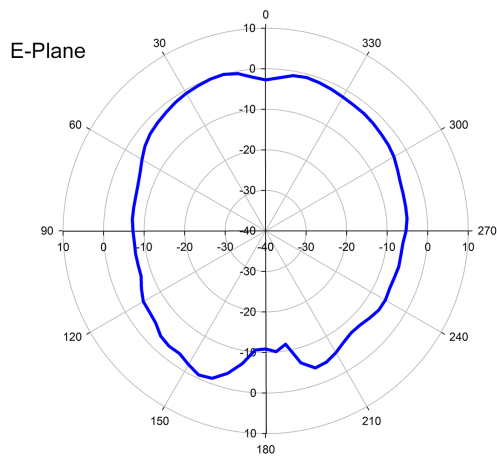

## 連接埠 1 頻率 : 5 GHz

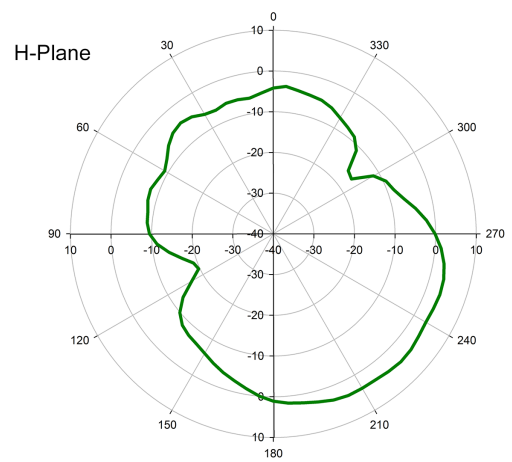
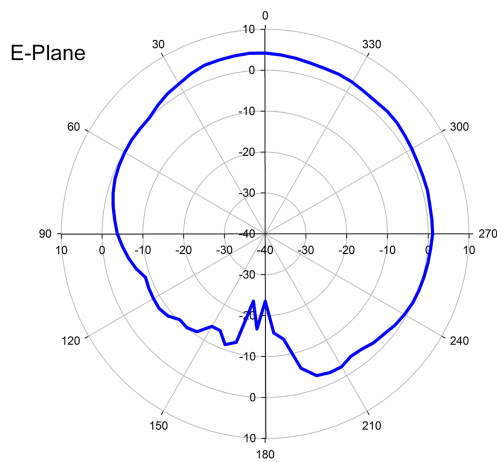

## 連接埠 2 頻率 : 5 GHz

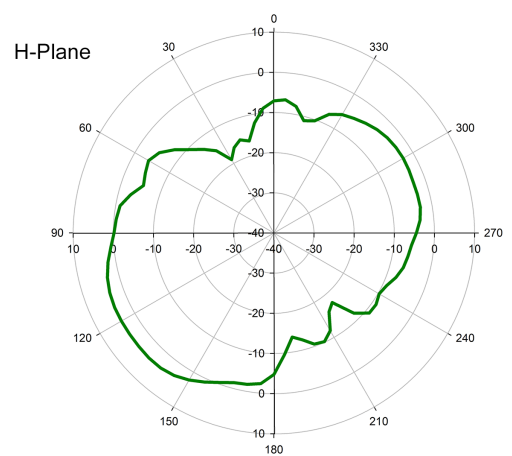
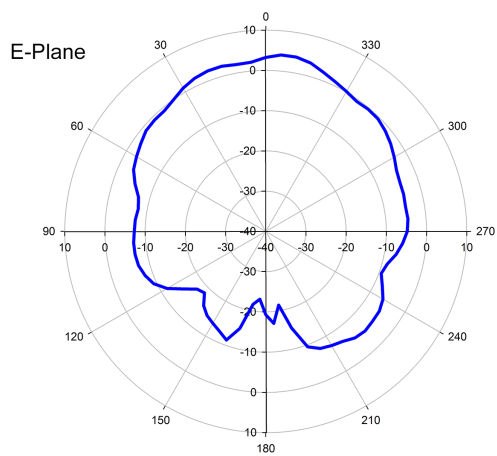

## 規格

### Antenna Characteristics

Frequency	2.4 to 2.5, 4.9 to 5.9 GHz
Antenna Type	MIMO 2x2, Omni-directional
Typical Antenna Gain	2/5 dBi
Connector	RP-SMA (male)

Impedance	50 ohms
Polarization	Linear
HPBW/Horizontal	360°
V.S.W.R.	2:1 max.
Power Handling	10 W (max.)

### Physical Characteristics

Weight	115 g (0.25 lb)
Height	37 mm (1.46 in)
Diameter	210.9 mm (8.3 in)
Radome Color	White
Radome Material	ABS
Installation	Ceiling mount
Cable	RG-178
Cable Length	250 mm (9.84 in)

### Environmental Limits

Operating Temperature	-40 to 75°C (-40 to 167°F)
Storage Temperature (package included)	-40 to 75°C (-40 to 167°F)
Ambient Relative Humidity	5 to 95% (30°C, non-condensing)

### Warranty

Warranty Period	1 year
Details	See <a href="http://www.moxa.com/tw/warranty">www.moxa.com/tw/warranty</a>

## 尺寸

單位：公釐

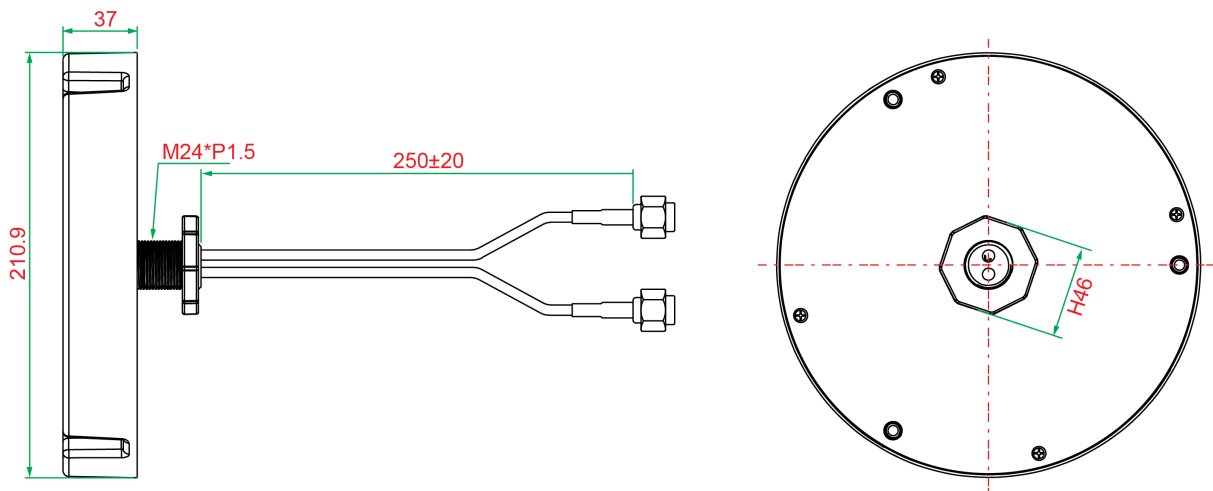

## 訂購資訊

Model Name	Frequency	Antenna Type	Antenna Gain	Connector
MAT-WDB-CA-RM-2-0205	2.4 to 2.5, 4.9 to 5.9 GHz	MIMO 2x2, Omni-directional	2/5 dBi	RP-SMA (male)

© Moxa Inc. 版權所有.2018 年 11 月 17 日更新。

未經 Moxa Inc. 明確書面許可，不得以任何方式複製或使用本文件及其任何部分。產品規格如有變更，恕不另行通知。請至本公司官網了解最新的產品資訊。