

# **EDS-4008 Series Quick Installation Guide**

---

**Moxa EtherDevice™ Switch**

**Version 1.1, November 2022**

**Technical Support Contact Information**  
**[www.moxa.com/support](http://www.moxa.com/support)**

**MOXA®**

© 2022 Moxa Inc. All rights reserved.

**P/N: 1802040080011**



## Package Checklist

The EDS-4008 Series industrial DIN-rail EtherDevice Switch (EDS) is shipped with the following items. If any of these items are missing or damaged, please contact your customer service representative for assistance.

- 1 EDS-4008 Ethernet switch
- Quick installation guide (printed)
- Warranty card
- Substance disclosure table
- Product certificate of quality inspection (Simplified Chinese)
- Product notices (Simplified Chinese)

**NOTE** You can find information and software downloads on the relevant product pages located on Moxa's website:  
[www.moxa.com](http://www.moxa.com)

## Default Settings

- IP address: 192.168.127.253
- Subnet Mask: 255.255.255.0
- Username: admin
- Password: moxa

## Panel Views of EDS-4008 Series

EDS-4008

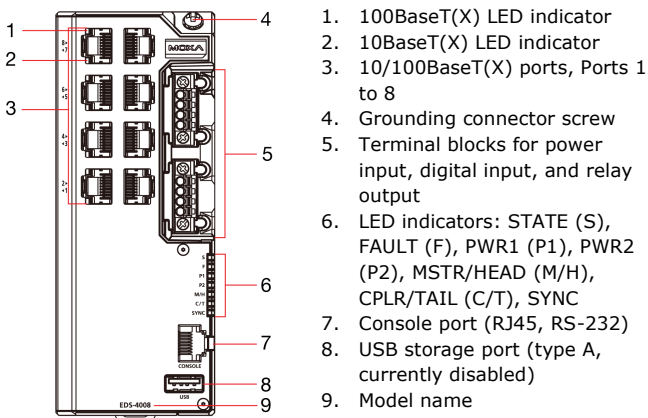

## EDS-4008-2MSC EDS-4008-2SSC

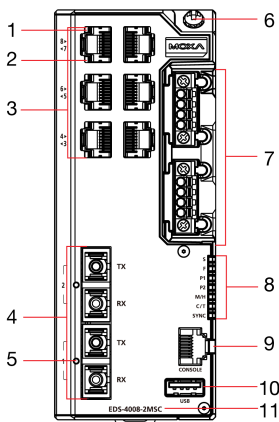

## EDS-4008-2MST

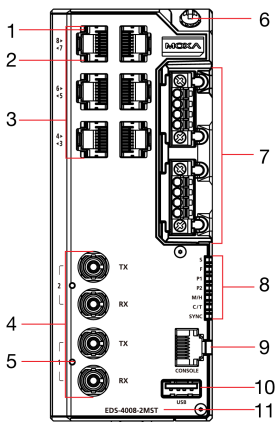

1. 100BaseT(X) LED indicator
2. 10BaseT(X) LED indicator
3. 10/100BaseT(X) ports, ports 3 to 8
4. 100BaseFX port (SC/ST type), port 1 and 2
5. 100BaseFX LED indicator
6. Grounding connector screw

7. Terminal blocks for power input, digital input, and relay output
8. LED indicators: STATE (S), FAULT (F), PWR1 (P1), PWR2 (P2), MSTR/HEAD (M/H), CPLR/TAIL (C/T), SYNC
9. Console port (RJ45, RS-232)
10. USB storage port (type A, currently disabled)
11. Model name

## EDS-4008-2GT-2GS

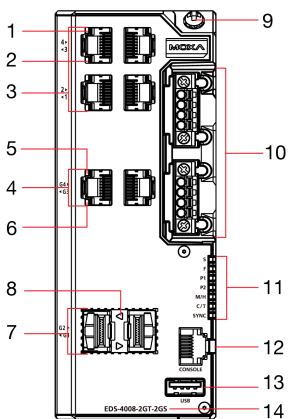

## EDS-4008-4P-2GT-2GS

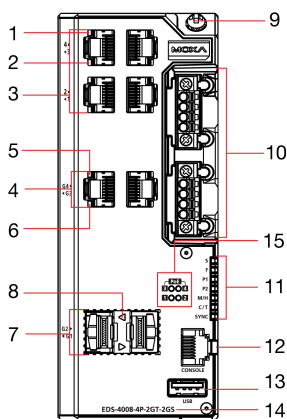

1. 100BaseT(X) LED indicator
2. 10BaseT(X) LED indicator
3. 10/100BaseT(X) ports, port 1 to 4
4. 10/100/1000BaseT(X) ports, port G3 to G4

8. 100/1000BaseSFP LED indicator
9. Grounding connector screw
10. Terminal blocks for power input, digital input, and relay output
11. LED indicators: STATE (S), FAULT (F), PWR1 (P1), PWR2

- |   |   |
|---|---|
| 5. 1000BaseT(X) LED indicator           | (P2), MSTR/HEAD (M/H), CPLR/TAIL (C/T), SYNC      |
| 6. 10/100BaseT(X) LED indicator         | 12. Console port (RJ45, RS-232)                   |
| 7. 100/1000BaseSFP ports, port G1 to G2 | 13. USB storage port (type A, currently disabled) |
|   | 14. Model name                                    |
|   | 15. SmartPoE LED indicator of PoE ports           |

### Bottom Panel View

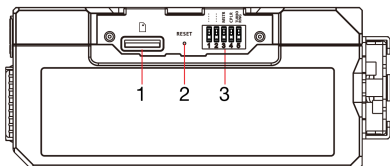

1. microSD card slot (currently disabled)
2. Reset button
3. DIP switches for Turbo Ring, Ring Master, and Ring Coupler

### Mounting Dimensions

#### EDS-4008(-T)/EDS-4008-2MSC(-T)/EDS-4008-2SSC(-T) Models

Unit: mm (inch)

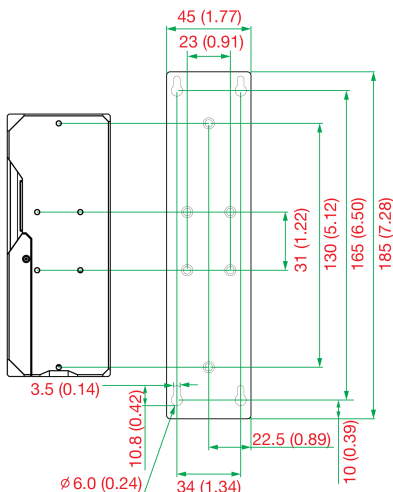
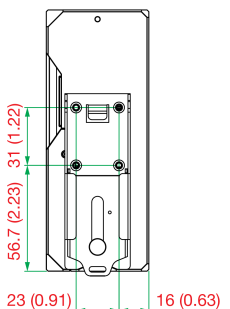
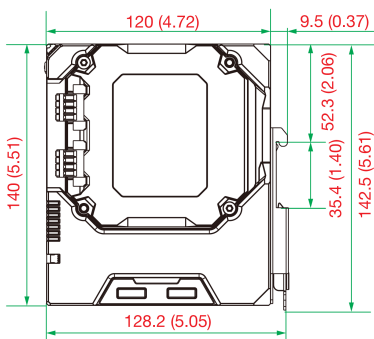
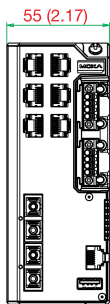

## EDS-4008-2MST(-T) Models

Unit: mm (inch)

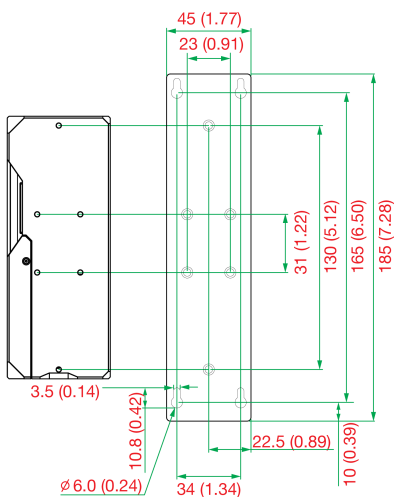
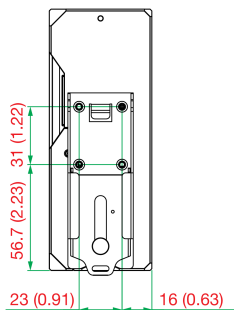
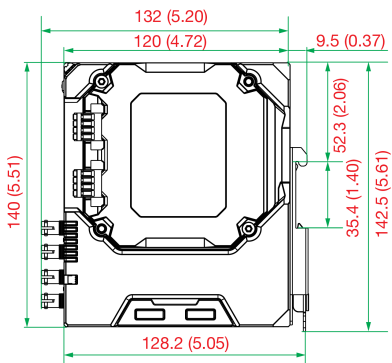
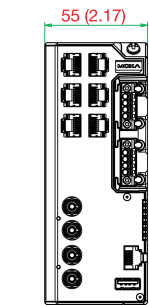

## EDS-4008-2GT-2GS(-T)/EDS-4008-4P-2GT-2GS(-T) Models

Unit: mm (inch)

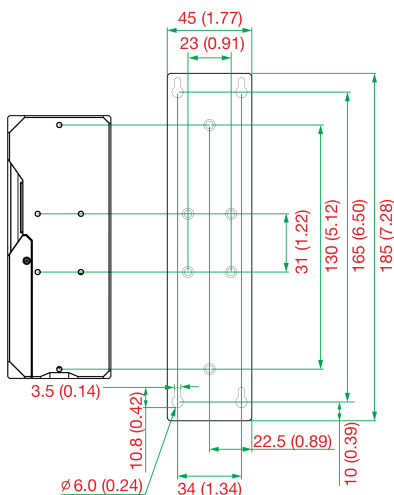
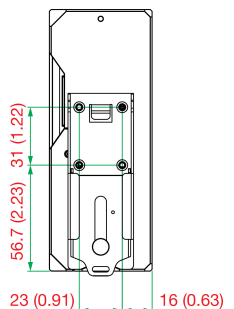
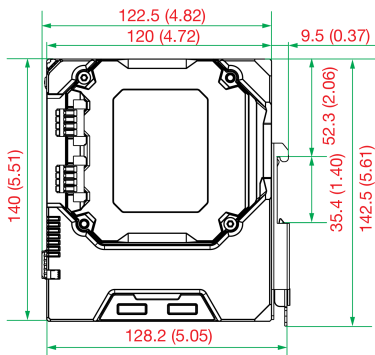
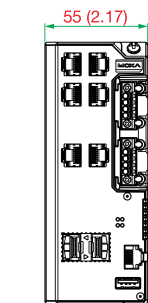

## DIN-rail Mounting

The DIN-rail mounting kit is fixed to the back panel of the EDS device when you take it out of the box. Mount the EDS device on corrosion-free mounting rails that meet the EN 60715 standard.

### Installation

**STEP 1**—Insert the upper lip of the DIN rail into the DIN-rail mounting kit.

**STEP 2**—Press the EDS device towards the DIN rail until it snaps into place.

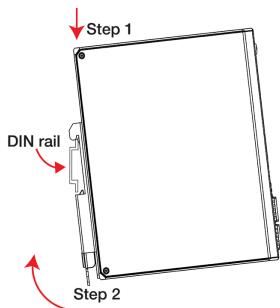

## Removal

**STEP 1**—Pull down the latch on the mounting kit with a screwdriver.

**STEP 2 & 3**—Slightly pull the EDS device forward and lift up to remove it from the DIN rail.

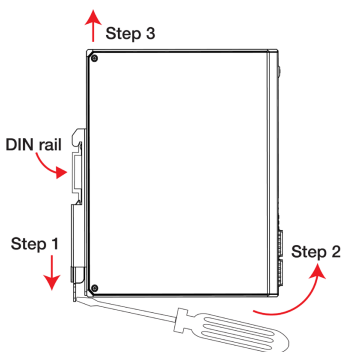
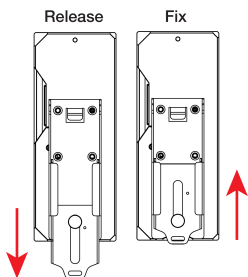

**NOTE** Our DIN rail kit now utilizes a quick release mechanism to make it easier for users to remove the DIN rail from the EDS device.

## Wall Mounting (Optional)

For some applications, you will find it convenient to mount the Moxa EDS device on a wall, as shown in the following illustrations:

**STEP 1**—Remove the DIN-rail attachment plate from the rear panel of the EDS device, and then attach the wall mount plates with M3 screws.

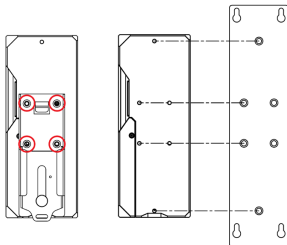

**STEP 2**—Mounting the EDS device on a wall requires four screws. Use the EDS device, with wall mount plates attached. The heads of the screws should be less than 6.0 mm in diameter, and the shafts should be less than 3.5 mm in diameter, as shown in the figure on at right.

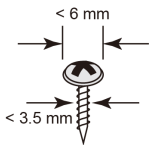

**NOTE** Before tightening the screws into the wall, make sure the screw head and shank size are suitable by inserting the screw through one of the keyhole-shaped apertures of the Wall Mounting Plates.

**NOTE** Do not screw the screws in all the way—leave about 2 mm to allow room for sliding the wall mount panel between the wall and the screws.

**STEP 3**—Once the screws are fixed to the wall, insert the four screw heads through the wide parts of the keyhole-shaped apertures, and then slide the EDS device downwards, as indicated in the figure at the right. Tighten the four screws for more stability.

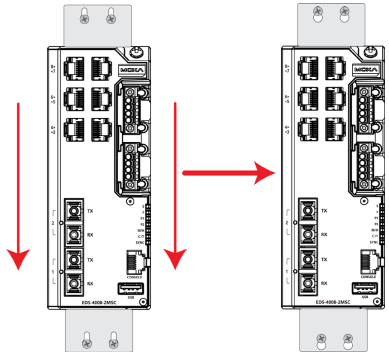

## Wiring Requirements



### ATTENTION

#### Safety First!

External metal parts are hot. Take the necessary precautions if you are required to handle the device.



### ATTENTION

In order to ensure reliable operations, please make sure the operating temperature of the environment does not exceed the specifications. When mounting an EDS device with other operating units in a cabinet without forced ventilation, a minimum of 4 cm space on both the left and right of the switch is recommended.



### ATTENTION

#### Safety First!

Be sure to disconnect the power cord before installing and/or wiring your EDS device. Calculate the maximum possible current in each power wire and common wire. Observe all electrical codes dictating the maximum current allowable for each wire size. If the current goes above the maximum ratings, the wiring could overheat, causing serious damage to your equipment.

Be sure to read and follow these important points below:

- Use separate paths to route wiring for power and devices. If power wiring and device wiring paths must cross, make sure the wires are perpendicular at the intersection point.



**NOTE** Do not run signal or communications wiring and power wiring through the same wire conduit. To avoid interference, wires with different signal characteristics should be routed separately.

- You can use the type of signal transmitted through a wire to determine which wires should be kept separate. The rule of thumb is that wiring that shares similar electrical characteristics can be bundled together.
- You should separate input wiring from output wiring.
- We advise that you label the wiring to all devices in your system.

## Grounding the Moxa EDS Series

Grounding and wire routing help limit the effects of noise due to electromagnetic interference (EMI). Run the ground connection from the ground screw (M4) to the grounding surface prior to connecting devices.

**NOTE** The grounding wire should have a minimum diameter of 1.5 mm<sup>2</sup>.



### **ATTENTION**

This product is intended to be mounted to a well-grounded mounting surface such as a metal panel.

## Suggested Wire Type for Wiring Relay Contact (RELAY), Digital Input (DI), and Power Inputs (P1/P2)

The EDS device includes two 4-pins 3.5 mm pin-pitch terminal blocks. When wiring the relay contact (RELAY), digital input (DI), and power inputs (P1/P2), we suggest using the cable type – AWG 18-24 and the corresponding pin type cable terminals.

**NOTE** The wire must be able to withstand at least 105°C and the torque value should be 4.5 lb-in (0.51 N-m).

**NOTE** We suggest the length of the pin type cable terminal is 8 mm.

In order to tighten the wire properly, ① use a small flathead screwdriver to press the push-in button beside each terminal of the terminal block connector before and during ② inserting the wire. ③ Release the screwdriver after the wire has been fully inserted. Please refer to the diagram below.

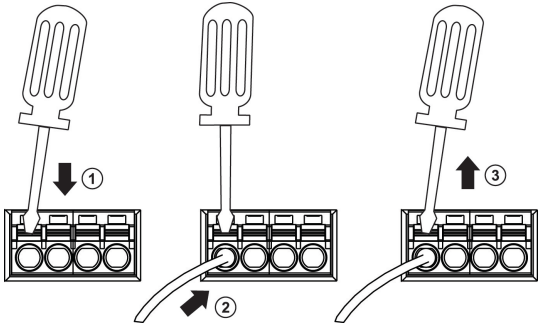

## Wiring the Relay Contact

The EDS device has one set of relay output. This relay contact uses two contacts of the terminal block on the EDS's power module. Refer to the section for detailed instructions on how to connect the wires to the terminal block connector, and how to attach the terminal block connector to the terminal block receptor.

LV Models

HV Models

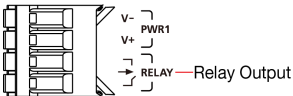
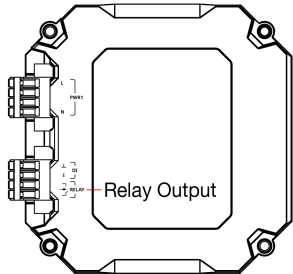
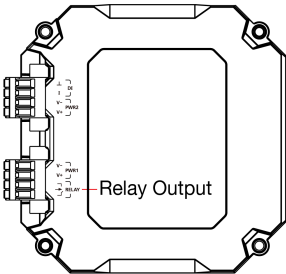

### Relay:

The two contacts of the 4-pin terminal block connector are used to detect user-configured events. The two wires attached to the fault contacts form an open circuit when a user-configured event is triggered or there is no power supply to the switch. If a user-configured event does not occur, the fault circuit remains closed.

## Wiring the Redundant Power Inputs

The EDS device includes both high-voltage and low-voltage products. For the low-voltage (LV models) products, there are two power inputs for redundancy; for the high-voltage (HV models) products, there is only one power input. Refer to the instructions and diagram below on how to connect the wires to the terminal block connector on the receptor.

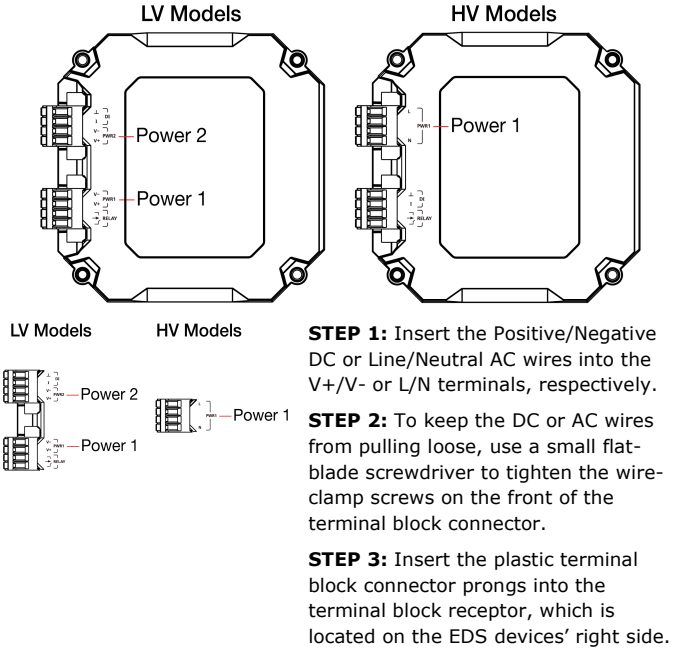

## Wiring the Digital Inputs

The EDS device has one set of digital input (DI). The DI consists of two contacts of the 4-pin terminal block connector on the EDS's right-side panel. Refer to the instructions and diagram below on how to connect the wires to the terminal block connector on the receptor.

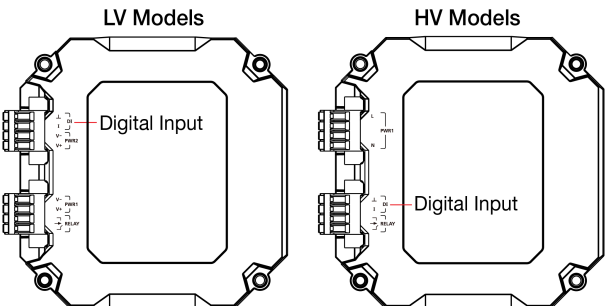

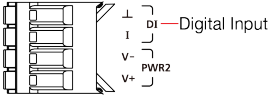

**STEP 1:** Insert the negative (ground)/positive DI wires into the  $\perp$ /I terminals, respectively.

**STEP 2:** To keep the DI wires from pulling loose, use a small flat-blade screwdriver to tighten the wire-clamp button on the front of the terminal block connector.

**STEP 3:** Insert the plastic terminal block connector prongs into the terminal block receptor, which is located on the EDS devices' right side.

## Rotating the Power Module

The power module for the EDS device can be rotated to make it easier to fit your field site application.

**Step 1:** Remove the two screws that fasten the power module to the EDS device.

**Step 2:** Remove the power module.

**Step 3:** Turn the power module clockwise so that the power, digital input, and relay output connectors can be moved upwards.

**Step 4:** Place the module back on to the EDS device and then fasten the two screws on to the module.

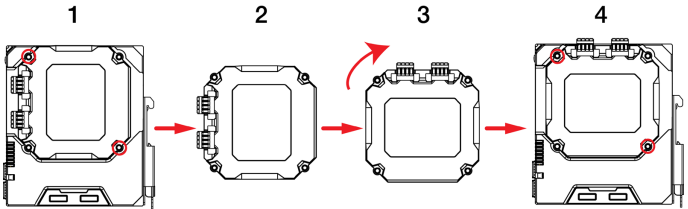

## Communication Connections

Each EDS-4008 Series switch has various types of communication ports:

- RJ45 console port (RS-232 interface)
- USB storage port (type A connector, currently disabled)
- microSD card slot (currently disabled)
- 10/100BaseTX Ethernet ports
- 100BaseFX (SC/ST-type connector) fiber ports
- 10/100/1000BaseT(X) Ethernet ports
- 100/1000BaseSFP ports

### Console Port Connection

The EDS device has one RJ45 console port (RS-232), located on the front panel. Use either an RJ45-to-DB9 (see the cable following wiring diagrams) to connect the EDS's console port to your PC's COM port. You may then use a console terminal program, such as Moxa PComm Terminal Emulator, to access the EDS that has a baud rate of 115200.

## RJ45 Console Port Pinouts

Pin	Description
1	DSR
2	RTS
3	-
4	TxD
5	RxD
6	GND
7	CTS
8	DTR

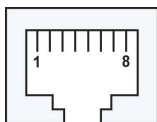

## USB Connection

**NOTE** The USB function is currently reserved and may be required in the future. It should be noted that this port cannot be used for charging any devices.

## 10/100BaseT(X) Ethernet Port Connection

The 10/100BaseT(X) ports located on the front panel of the switch are used to connect to Ethernet-enabled devices. Most users will choose to configure these ports for Auto MDI/MDI-X mode, in which case the port's pinouts are adjusted automatically depending on the type of Ethernet cable used (straight-through or cross-over), and the type of device (NIC-type or HUB/Switch-type) connected to the port.

In what follows, we give pinouts for both MDI (NIC-type) ports and MDI-X (HUB/Switch-type) ports. We also give cable wiring diagrams for straight-through and cross-over Ethernet cables.

### 10/100Base T(x) RJ45 Pinouts

#### MDI Port Pinouts

Pin	Signal
1	Tx+
2	Tx-
3	Rx+
6	Rx-

#### MDI-X Port Pinouts

Pin	Signal
1	Rx+
2	Rx-
3	Tx+
6	Tx-

#### 8-pin RJ45

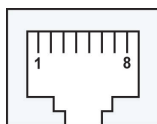

## RJ45 (8-pin) to RJ45 (8-pin) Straight-Through Cable Wiring

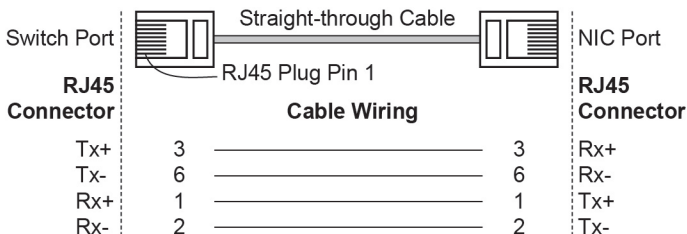

## RJ45 (8-pin) to RJ45 (8-pin) Cross-Over Cable Wiring

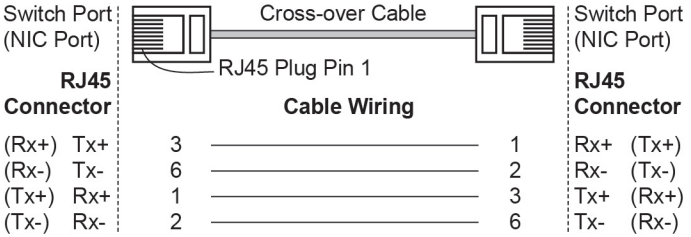

## 100BaseFx Ethernet Port Connection

The concept behind the SC/ST port and cable is quite straightforward. Suppose you are connecting devices I and II. As opposed to electrical signals, optical signals do not require a circuit in order to transmit data. Consequently, one of the optical lines is used to transmit data from device I to device II, and the other optical line is used to transmit data from device II to device I, for full-duplex transmission.

All you need to remember is to connect the Tx (transmit) port of device I to the Rx (receive) port of device II, and the Rx (receive) port of device I to the Tx (transmit) port of device II. If you are making your own cable, we suggest labeling the two sides of the same line with the same letter (A-to-A and B-to-B, as shown by the following illustration, or A1-to-A2 and B1-to-B2).

### SC-Port Pinouts

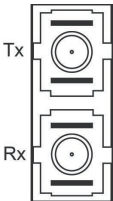

### SC-Port to SC-Port Cable Wiring

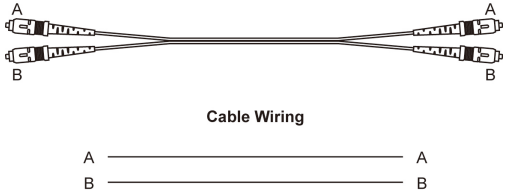

### ST-Port Pinouts

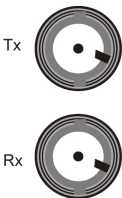

### ST-Port to ST-Port Cable Wiring

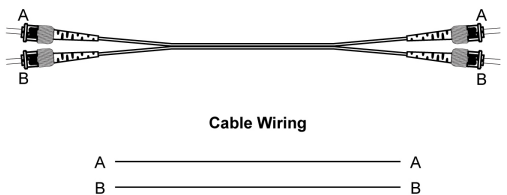

## ATTENTION

This is a Class 1 Laser/LED product. To prevent damage to your eyes, do not stare directly into the laser beam.

## 1000BaseT(X) Ethernet Port Connection

1000BaseT(X) data is transmitted on differential TRD+/- signal pairs over copper wires.

### MDI/MDI-X Port Pinouts

Pin	Signal
1	TRD(0)+
2	TRD(0)-
3	TRD(1)+
4	TRD(2)+
5	TRD(2)-
6	TRD(1)-
7	TRD(3)+
8	TRD(3)-

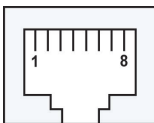

## 100/1000BaseSFP (mini-GBIC) Fiber Port

The Gigabit Ethernet fiber ports on the switch are 100/1000BaseSFP fiber ports, which require using 100M or 1G mini-GBIC fiber transceivers to work properly. Moxa provides a complete selection of transceiver models for different distance requirements.

The concept behind the LC port and cable is straightforward. Suppose you are connecting devices I and II; contrary to electrical signals, optical signals do not require a circuit in order to transmit data. Consequently, one of the optical lines is used to transmit data from device I to device II, and the other optical line is used to transmit data from device II to device I, for full-duplex transmission.

Remember to connect the Tx (transmit) port of device I to the Rx (receive) port of device II, and the Rx (receive) port of device I to the Tx (transmit) port of device II. If you make your own cable, we suggest labeling the two sides of the same line with the same letter (A-to-A and B-to-B, as shown below, or A1-to-A2 and B1-to-B2).

### LC-Port Pinouts

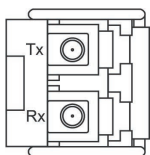

### LC-Port to LC-Port Cable Wiring

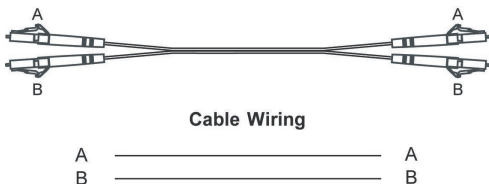

### ATTENTION

This is a Class 1 Laser/LED product. To avoid causing serious damage to your eyes, do not stare directly into the Laser Beam.

## Reset Button

There are two functions available on the Reset Button. One is to reset the Ethernet switch to factory default settings by pressing and holding the Reset button for 5 seconds. Use a pointed object, such as a straightened paper clip or toothpick, to depress the Reset button. This will cause the STATE LED to blink once a second. After depressing the button for 5 continuous seconds, the STATE LED will start to blink rapidly. This indicates that factory default settings have been loaded and you can release the reset button. The other function is to reboot the device by depressing reset button for less than five seconds.

## Turbo Ring DIP Switch Settings

The EDS devices are plug-and-play managed redundant Ethernet switches. The proprietary Turbo Ring protocol was developed by Moxa to provide better network reliability and faster recovery time. Moxa Turbo Ring's recovery time is less than 50 ms (**Turbo Ring V2**) — compared to a 3- to 5-minute recovery time for commercial switches— decreasing the possible loss caused by network failures in an industrial setting.

There are five Hardware DIP Switches for Turbo Ring on the bottom panel of the EDS device that can help setup the Turbo Ring easily within seconds. If you do not want to use a hardware DIP switch to setup the Turbo Ring, you can use a web browser, telnet, or console to disable this function.

**NOTE** Please refer to the **Turbo Ring** section in User's Manual for more detail information about the setting and usage of **Turbo Ring V2**.

### Turbo Ring DIP Switch Settings

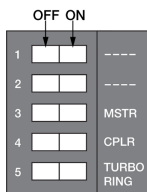

The default setting for each DIP Switch is OFF. The following table explains the effect of setting the DIP Switch to the ON position.

Remove the rubber cover on the bottom panel of the device to expose the DIP switches.

### DIP Switch Settings

DIP 1	DIP 2	DIP 3	DIP 4	DIP 5
Reserved for future use	<b>ON:</b> Enables the default "Ring Coupling (backup)" port when DIP switch 4 is already enabled.	<b>ON:</b> Enables this EDS as the Ring Master.	<b>ON:</b> Enables the default "Ring Coupling" port.	<b>ON:</b> Activates DIP switch 2, 3, and 4 to configure Turbo Ring V2 settings.
	<b>OFF:</b> Enables the default Ring Coupling (primary) port when DIP switch 4 is already enabled.	<b>OFF:</b> This EDS will not be the Ring Master.	<b>OFF:</b> This EDS will not be the Ring Coupler.	<b>OFF:</b> DIP switch 2, 3, and 4 will be disabled.



**NOTE** You must enable the **Turbo Ring** (DIP switch 5) first before using the DIP switch to activate the Master and Coupler functions.

**NOTE** If you do not enable any of the EDS switches to be the Ring Master, the Turbo Ring protocol will automatically choose the EDS switch with the smallest MAC address range to be the Ring Master. If you accidentally enable more than one switch to be the Ring Master, these switches will auto-negotiate to determine which one will be the Ring Master.

## LED Indicators

The front panel of the Moxa EDS-4008 Series contains several LED indicators. The function of each LED is described in the following table:

### Device LED Indicators

LED	Color	State	Description
STATE	Green	On	When system has passed power-on self-test (POST) and is ready to run.
		Blinking (1 time/sec)	Press the reset button for five seconds to reset to factory default settings.
		Blinking (4 times/sec)	When pressing the reset button depress for 5 seconds to reset to factory default.
	Off	N/A	
	Red	On	The system has initially failed the boot-up process <ul style="list-style-type: none"> <li>System Info. Read Fail or EEPROM information error.</li> </ul>
FAULT	Red	On	<ol style="list-style-type: none"> <li>The relay contact has been triggered.</li> <li>The ingress rate limit has been exceeded and the port has entered shut down mode.</li> <li>Invalid Ring port connection.</li> </ol>
		Off	When the system boots up and runs correctly or a user-configured event is not triggered.
P1	Amber	On	Power is being supplied to power input PWR.
		Off	Power is not being supplied to power input PWR.
P2	Amber	On	Power is being supplied to power input PWR.
		Off	Power is not being supplied to power input PWR.

LED	Color	State	Description
<b>MSTR/ HEAD (M/H)</b>	<b>Green</b>	<b>On</b>	When the switch is Master/Head/Root of Turbo Ring/Turbo Chain/Fast RSTP.
		<b>Blinking (4 times/sec)</b>	<ol style="list-style-type: none"> <li>1. The switch has become the Master of Turbo Ring after Turbo Ring has gone down.</li> <li>2. The switch is set as Head of Turbo Chain and Turbo Chain has gone down.</li> <li>3. The switch is set as the Turbo Ring's Member and the corresponding Ring port is down.</li> <li>4. The switch is set as the Turbo Chain's Member/Tail and the corresponding Head-end Chain port is down.</li> </ol>
		<b>Off</b>	When the switch is not the Master/Head/Root of this Turbo Ring/ Turbo Chain/Fast RSTP.
<b>CPLR/ TAIL</b>	<b>Green</b>	<b>On</b>	<ol style="list-style-type: none"> <li>1. The switch's ring coupling or dual homing function is enabled.</li> <li>2. The switch is set as the Tail of Turbo Chain.</li> </ol>
		<b>Blinking (4 times/sec)</b>	<ol style="list-style-type: none"> <li>1. The switch is set as the Tail of Turbo Chain and the Chain has gone down.</li> <li>2. The switch is set as the Turbo Chain's Member/Head and the corresponding Tail-end Chain port is down.</li> </ol>
		<b>Off</b>	When the switch disables the coupling or tail role of Turbo Chain.
<b>System LED (Except PWR)</b>	<b>Green + Amber + Red</b>	<b>Blinking (2 times/sec)</b>	The switch is being discovered/located by the locator function.
<b>System LED (Except PWR)</b>	<b>Green + Amber + Red</b>	<b>Rotate On -&gt; Off Sequentially</b>	The switch is importing/exporting a file via ABC-02-USB or SD card. (currently disabled)

## Smart PoE LED Indicators

LED	Color	State	Description
Smart PoE+ LED Indicators	Green	On	When the port is connected to IEEE 802.3bt powered device and powered at: <ul style="list-style-type: none"> <li>• Single signature (PD) Class 5 to 8.</li> <li>• Dual signature (PD) Class 1 to 5.</li> </ul>
		Off	<ol style="list-style-type: none"> <li>1. When the power is not being supplied to a powered device (PD).</li> <li>2. The port is not connected to an IEEE 802.3bt powered device.</li> </ol>
	Amber	On	When the port is connected to IEEE 802.3af/at powered device and powered at: <ul style="list-style-type: none"> <li>• Single signature (PD) 0 to 4.</li> </ul>
		Blinking (4 times/sec)	The PoE power supply has been shut off because of low power budget.
		Off	<ol style="list-style-type: none"> <li>1. Power is not being supplied to the powered device (PD).</li> <li>2. The port is not connected to an IEEE 802.3af/at standard PD.</li> </ol>
	Red	On	Powered device (PD) detection failure.
		Blinking (4 times/sec)	Overcurrent has occurred on the powered Device (PD).
		Off	PoE is operating normally.

## Ports LED Indicators

LED	Color	State	Description
10M/ 100M Copper top LED	Green	On	When the port is active and links at 100Mbps.
		Blinking (4 times/sec)	When the port's data is being transmitted at 100Mbps.
		Off	When the port is inactive or link down.
10M/ 100M Copper bottom LED	Amber	On	When the port is active and links at 10Mbps.
		Blinking (4 times/sec)	When the port's data is being transmitted at 10Mbps.
		Off	When the port is inactive or link down.
10M/ 100M/ 1000M Copper top LED	Green	On	When the port is active and links at 1000Mbps.
		Blinking (4 times/sec)	When the port's data is being transmitted at 1000Mbps.
		Off	When the port is inactive or link down.
10M/ 100M/ 1000M Copper bottom LED	Amber	On	When the port is active and links at 10/100Mbps.
		Blinking (4 times/sec)	When the port's data is being transmitted at 10/100Mbps.
		Off	When the port is inactive or link down.
100M Fiber LED	Green	On	When the port's data is being transmitted at 100Mbps.
		Blinking (4 times/sec)	When the port's data is being transmitted at 100Mbps.
		Off	When the port is inactive or link down.
100M/ 1000M (SFP port)	Green	On	When the port is active and links at 1,000Mbps.
		Blinking (4 times/sec)	When the port's data is being transmitted at 1,000Mbps.
		Off	When the port is inactive or link down.
	Amber	On	When the port is active and links at 100Mbps.
		Blinking (4 times/sec)	When the port's data is being transmitted at 100Mbps.
		Off	When the port is inactive or link down.

## Specifications

Interface	
RJ45 Ports	10/100BaseT(X) or 10/100/1000BaseT(X)
Fiber Ports	100BaseFx 100/1000BaseSFP
Console Port	RS-232 (RJ45)
Button	Reset button
LED Indicators	STATE (S), FAULT (F), PWR1 (P1), PWR2 (P2), MSTR/HEAD (M/H), CPLR/TAIL (C/T), SYNC
Alarm Contact	1 normally open electromagnetic relay output with current carrying capacity of 1 A @ 24 VDC
Digital Input	1 isolated digital input: +13 to +30V for state "1" -30 to +3V for state "0" Max. input current: 8 mA
PoE	
<b>CAUTION:</b> When it is necessary to connect the PoE ports of a Power Bypass (-LVA) model to a Power Boost (-LVB) model within the same system, do not use the same power supply to power both models.	
Total Power Budget	Power Bypass (-LVA model): 240 W @ 48 VDC power input Power Boost (-LVB model): 62 W @ 12 VDC, 150 W @ 24 VDC (120 W for -T model), 180 W @ 48 VDC
PoE Output Voltage	55 VDC
PoE Output Power	15.4 W for the 802.3af standard, 30 W for the 802.3at standard, 36 W in high power mode, 60 W in 802.3bt standard
PoE Output Current	350 mA for the 802.3af standard, 600 mA for the 802.3at standard, 1960 mA for the 802.3bt standard
Overload Current Protection at Port	Present
PoE Pinout	Mode A: Pair 1,2 (V+); Pair 3,6 (V-) Mode B: pair 4,5 (V+); pair 7,8 (V-)
Power	
Pre-installed Power Module	-LV/-LV-T models: PWR-100-LV -HV/-HV-T models: PWR-105-HV-I -LVA/-LVA-T models: PWR-101-LV-BP-I -LVB/-LVB-T models: PWR-103-LV-VB-I
Note	The EDS-4008 Series supports modular power supplies. The model names and power parameters are determined by the installed power module.  For example: EDS-4008-T + PWR-100-LV = EDS-4008-LV-T EDS-4008-T + PWR-105-HV-I = EDS-4008-HV-T  If you install a different power module, refer to the specifications of the corresponding model. For example, if you replace the power module of the EDS-4008-LV-T with the PWR-105-HV-I, refer to the specifications of the EDS-4008-HV-T.

Rated Voltage	-LV/-LV-T models: 12/24/48 VDC, redundant dual inputs -HV/-HV-T models: 110/220 VDC/VAC, single input -LVA/-LVA-T models: 48 VDC, redundant dual inputs -LVB/-LVB-T models: 12/24/48 VDC, redundant dual inputs
Operating Voltage	-LV/-LV-T models: 9.6 to 60 VDC -HV/-HV-T models: 88 to 300 VDC, 85 to 264 VAC -LVA/-LVA-T models: 44 to 57 VDC (>52 VDC for PoE+ output recommended) -LVB/-LVB-T models: 12 to 57 VDC (>52 VDC for PoE+ output recommended)
Rated Current	-LV/-LV-T models: 12-48 VDC, 1.50-0.40 A or 24 VDC, 0.70 A -HV/-HV-T models: 110-220 VAC, 50-60 Hz, 0.30-0.20 A or 110-220 VDC, 0.30-0.20 A -LVA/-LVA-T models: 48 VDC, 5.42 A -LVB/-LVB-T models: 12/48 VDC, 7.46/4.27 A or 24 VDC, 7.26 A
Power Consumption	EDS-4008-LV(-T) models: 7.20 W EDS-4008-HV(-T) models: 8.13 W EDS-4008-2MST-LV(-T) models: 8.45 W EDS-4008-2MST-HV(-T) models: 11.13 W EDS-4008-2MSC-LV(-T) models: 8.45 W EDS-4008-2MSC-HV(-T) models: 11.09 W EDS-4008-2SSC-LV(-T) models: 8.98 W EDS-4008-2SSC-HV(-T) models: 11.37 W EDS-4008-2GT-2GS-LV(-T) models: 9.41 W EDS-4008-2GT-2GS-HV(-T) models: 11.17 W EDS-4008-4P-2GT-2GS-LVA(-T) models: Without PoE: 11.22 W With PoE: Max. 240 W for total PD power consumption @ 48 VDC input EDS-4008-4P-2GT-2GS-LVB(-T) models: Without PoE: 15.84 W With PoE: Max. 180 W for total PD power consumption @ 48 VDC input; Max. 150 W for total PD power consumption @ 24 VDC input; Max. 62 W for total PD power consumption @ 12 VDC input
Inrush Current	Max. 0.8 A @ 48 VDC (0.1 – 1 ms) (Applies to -LV models)
Overload Current Protection at Input	Present
Reverse Polarity Protection	Present
Connection	2 removable 4-contact terminal blocks
<b>Physical Characteristics</b>	
Housing	Metal, IP40 protection
Dimension	<b>EDS-4008(-T)/EDS-4008-2MSC(-T)/EDS-4008-2SSC(-T) Models:</b> 55 x 140 x 120 mm (2.17 x 5.51 x 4.72 in)

	<b>EDS-4008-2MST(-T) Models:</b> 55 x 140 x 132 mm (2.17 x 5.51 x 5.20 in) <b>EDS-4008-2GT-2GS(-T)/EDS-4008-4P-2GT-2GS(-T) Models:</b> 55 x 140 x 122.5 mm (2.17 x 5.51 x 4.82 in)
Weight	EDS-4008(-T) models: 857 g (1.89 lb) EDS-4008-2MSC(-T) models: 886 g (1.95 lb) EDS-4008-2MST(-T) models: 810 g (1.79 lb) EDS-4008-2SSC(-T) models: 882 g (1.94 lb) EDS-4008-2GT-2GS(-T) models: 795 g (1.75 lb) EDS-4008-4P-2GT-2GS(-T) models: 840 g (1.85 lb)
Installation	DIN-rail mounting, wall mounting (with optional kit)
<b>Environmental Limits</b>	
Operating Temperature	-10 to 60°C (14 to 140°F) for standard models -40 to 75°C (-40 to 167°F) for -T models
Storage Temperature	-40 to 85°C (-40 to 185°F)
Ambient Relative Humidity	5 to 95% (non-condensing)
Altitude	Up to 2000 m Note: Please contact Moxa if you require products guaranteed to function properly at higher altitude.
<b>Regulatory Approvals</b>	
Industrial Cybersecurity	IEC 62443-4-1, IEC 62443-4-2
Safety	UL 61010-2-201, EN 62368-1(LVD)
EMC	EN 55032/35, EN 61000-6-2/6-4
EMI	FCC Part 15 Subpart B Class A
EMS	EN 61000-4-2 (ESD) Level 4 EN 61000-4-3 (RS) Level 3 EN 61000-4-4 (EFT) Level 4 EN 61000-4-5 (Surge) Level 4 EN 61000-4-6 (CS) Level 3 EN 61000-4-8 Level 4
Shock	IEC 60068-2-27
Free Fall	IEC 60068-2-32
Vibration	IEC 60068-2-6
Hazardous Location	Class I Division 2, ATEX, IECEx
Rail Traffic (Wayside)	EN 50121-4
Traffic Control	NEMA TS2
<b>Warranty</b>	
Warranty	5 years





## ATTENTION

This device complies with Part 15 of the FCC rules.

Operation is subject to the following conditions:

1. This device may not cause harmful interference.
2. This device must accept any interference received including interference that may cause undesired operation.

## Hazardous Location Information (except for PoE and HV models)

ATEX information	  II 3G Ex ec nC IIC T4 Gc UL 22 ATEX 2741X Ambient Range: $-40^{\circ}\text{C} \leq T_{\text{amb}} \leq +75^{\circ}\text{C}$ for -T models Ambient Range: $-10^{\circ}\text{C} \leq T_{\text{amb}} \leq +60^{\circ}\text{C}$ for models without "-T" Rated Cable Temp. $\geq 90.4^{\circ}\text{C}$ <b>WARNING-DO NOT SEPARATE WHEN ENERGIZED</b>
IECEX Certificate no.	IECEX UL 22.0031X
Address of manufacturer	No. 1111, Heping Rd., Bade Dist., Taoyuan City 334004, Taiwan



### **WARNING – EXPLOSION HAZARD**

Do not disconnect this equipment unless the power source has been removed or turned off, or the installation location is known to be non-hazardous.

## Standards and Certifications

Hazardous Location	IEC 60079-0, Edition 7 IEC 60079-7, Edition 5.1 IEC 60079-15, Edition 5 EN IEC 60079-0:2018 EN IEC 60079-7:2015+A1:2018 EN IEC 60079-15:2019
--------------------	---

## Specific Condition of Use

- The equipment shall only be used in an area of at least pollution degree 2, as defined in IEC/EN 60664-1.
- The equipment shall be installed in an enclosure that provides a minimum ingress protection of IP 54 in accordance with IEC/EN 60079-0 and accessible only by use of a tool.