

RKP-A110 Series Hardware User Manual

Version 1.1, February 2024

www.moxa.com/products



© 2024 Moxa Inc. All rights reserved.

RKP-A110 Series Hardware User Manual

The software described in this manual is furnished under a license agreement and may be used only in accordance with the terms of that agreement.

Copyright Notice

© 2024 Moxa Inc. All rights reserved.

Trademarks

The MOXA logo is a registered trademark of Moxa Inc.
All other trademarks or registered marks in this manual belong to their respective manufacturers.

Disclaimer

- Information in this document is subject to change without notice and does not represent a commitment on the part of Moxa.
- Moxa provides this document as is, without warranty of any kind, either expressed or implied, including, but not limited to, its particular purpose. Moxa reserves the right to make improvements and/or changes to this manual, or to the products and/or the programs described in this manual, at any time.
- Information provided in this manual is intended to be accurate and reliable. However, Moxa assumes no responsibility for its use, or for any infringements on the rights of third parties that may result from its use.
- This product might include unintentional technical or typographical errors. Changes are periodically made to the information herein to correct such errors, and these changes are incorporated into new editions of the publication.

Technical Support Contact Information

www.moxa.com/support

Table of Contents

1. Introduction	5
Overview	5
Package Checklist	5
Product Features	5
Hardware Specifications	6
2. Hardware Introduction	7
Appearance	7
Dimensions	9
LED Indicators	9
Reset Button	9
Real Time Clock (RTC)	10
3. Hardware Connections	11
Installing Rack-mounting Ears	11
Connecting the Power	12
Wiring Requirements	13
Ethernet Ports	14
Serial Ports	14
Digital Inputs/Digital Outputs	14
Connecting USB Devices	15
Installing Storage Disks	15
Connecting to Displays	17
Replacing the RTC Battery	17
4. BIOS Setup	19
Entering the BIOS Setup	19
Main Page	21
Advanced Settings	22
Boot Configuration	22
SATA Configuration	23
CPU Configuration	24
Video Configuration	25
Chipset Configuration	26
Console Redirection	27
SIO ITE8786E	28
Hardware Monitor	29
Security Settings	30
Current TPM Device	30
TPM State	30
Clear TPM	30
Set Supervisor Password	31
Power Settings	32
Wake on LAN	32
Auto Wake on S5	32
Boot Settings	33
Network Stack	33
PXE Boot capability	33
USB Boot	33
Timeout	34
EFI	34
Exit Settings	35
Exit Saving Changes	35
Save Change Without Exit	35
Exit Discarding Changes	35
Load Optimal Defaults	35
Load Custom Defaults	36
Save Custom Defaults	36
Discard Changes	36
Administering Secure Boot	36
Enabling UEFI Secure Boot	37

Enroll EFI Image	37
Enroll Customer Key	39
Upgrading the BIOS	40
A. Safety Installation Instructions	44

1. Introduction

Thank you for purchasing the Moxa RKP-A110 industrial computer. This manual covers hardware installation, connector interfaces, and BIOS setup of the RKP-A110. For software configuration and management, please refer to the user manual for the operating system on your computer.

Overview

The RKP-A110 rackmount computers are powered by either an Intel Atom® x6211E dual-core 1.30 GHz or Intel Atom® x 6425E quad-core 2.0 GHz processor. The computers come with a rich set of interface options including up to 10 software-selectable RS-232/422/485 serial ports, up to 12 Gigabit Ethernet ports, and 8 digital inputs and 8 digital outputs. The communication interfaces are located on the front and rear sides of the product, enabling easy access and expansion for industrial applications. Two hand-rotated 2.5" SSD storages and an outer replaceable RTC battery design deliver a reliable, durable, and versatile platform for a more user-friendly option.

Designed as 1U standard form factor fanless rackmount computers with an operating temperature range of -30 to 60°C and a build-in TPM 2.0 module, the RKP-A110 computers are ideal as reliable and secure computing platforms for industrial applications in extreme operating environments.

Package Checklist

Each basic system model is shipped with the following standard items:

- RKP-A110 Series rackmount computer (mounting ears attached)
- 2-pin terminal block for DC power
- 2 10-pin terminal block for DI/DO
- Pack of 8 screws for the storage trays
- Quick Installation Guide
- Warranty card



NOTE

Please notify your sales representative if any of the above items are missing or damaged.

Product Features

The RKP-A110 computer has the following features:

- 1U rackmount computer with fanless design
- Intel Atom® x6211E dual-core 1.30 GHz or Intel Atom® x 6425E quad-core 2.0 GHz processor
- Rich interface options for up to 10 serial ports or up to 12 LAN ports
- -30 to 60°C wide-temperature design
- Standard form factor to fit in industrial application
- Front-side interface design for easy access

Hardware Specifications



NOTE

The latest specifications for Moxa's products can be found at <https://moxa.com>.

2. Hardware Introduction

In this chapter, we provide information about the RKP-A110 computer's hardware components.

Appearance

Front View

RKP-A110-E2-T/RKP-A110-E4-T Models

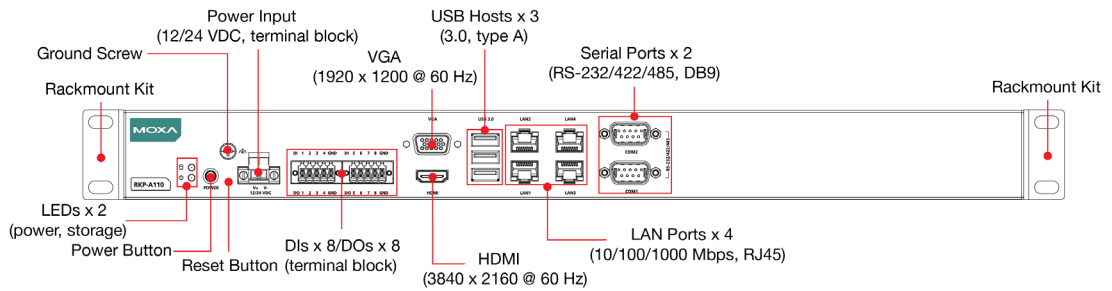

RKP-A110-E2-8L-T/RKP-A110-E4-8L-T Models

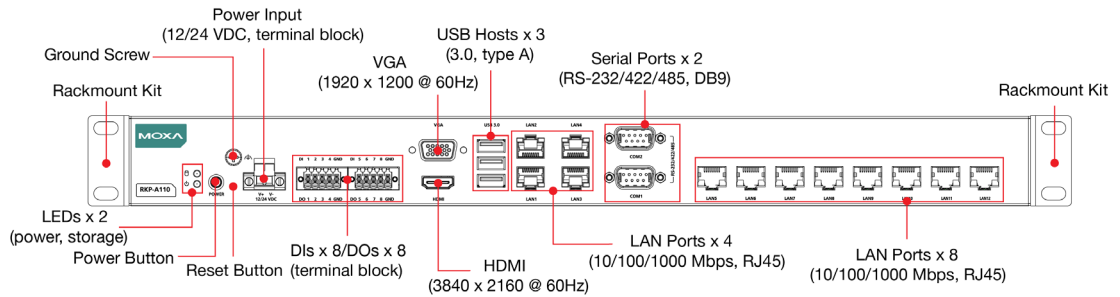

RKP-A110-E2-8C-T/RKP-A110-E4-8C-T Models

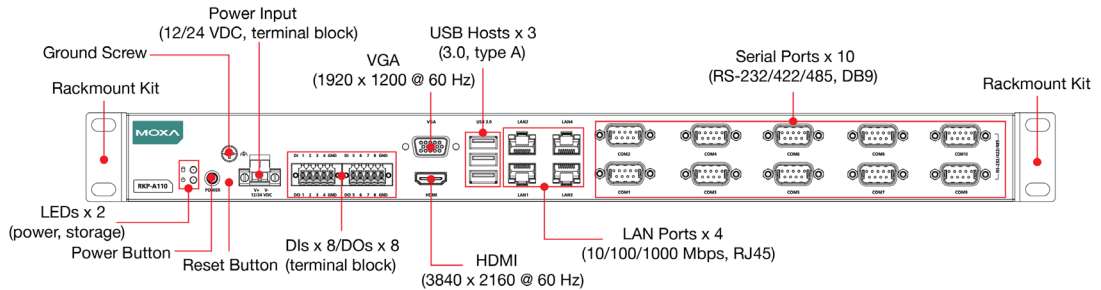

RKP-A110-E2-2L4C-T/RKP-A110-E4-2L4C-T Models

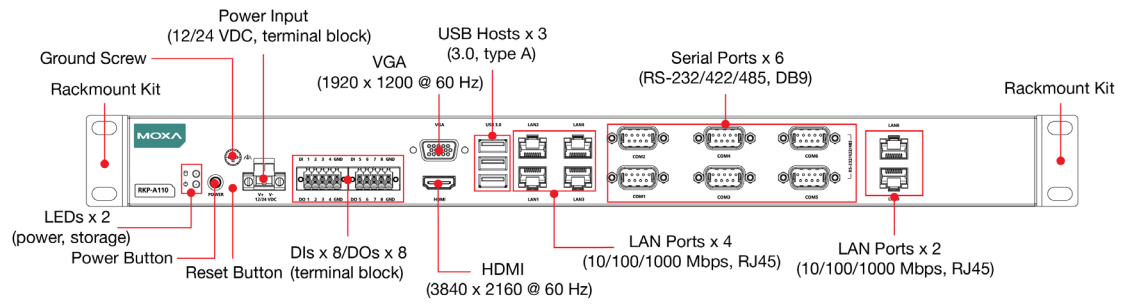

Rear View

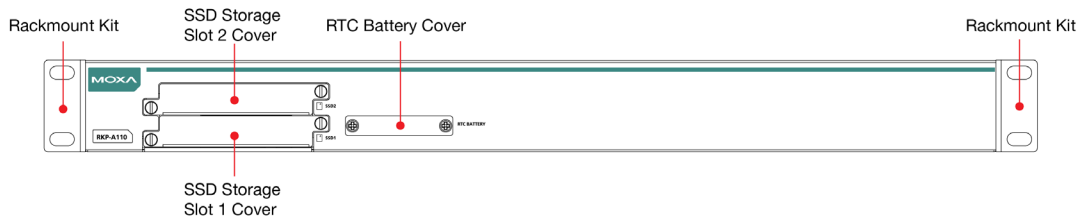

Dimensions

Unit: mm (inch)

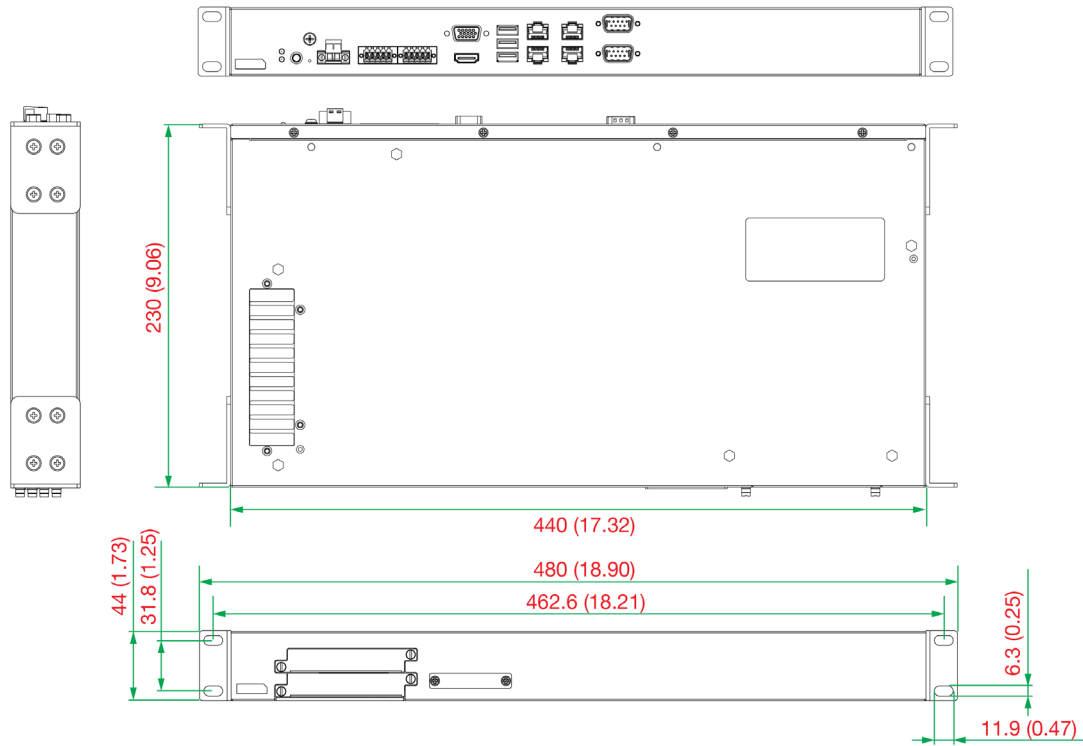

LED Indicators

The following table describes the function of the LED indicators located on the front panel of the computer.

LED	Color	Description
Power	Green	Power is ON
	OFF	No power input or any other power error
Ethernet (10/100 Mbps) (1000 Mbps)	Green	Steady ON: 10/100 Mbps Ethernet link Blinking: Data is being transmitted or received
	Yellow	Steady ON: 1000 Mbps Ethernet link Blinking: Data is being transmitted or received
	OFF	No Ethernet connection
Storage (2.5" SSD)	Yellow	Blinking: Data is being accessed from the SSD drive
	OFF	Data is not being accessed from the SSD drive

Reset Button

Pressing the **Reset** button, located on the front panel, initiates a hardware warm reboot. The button plays the same role as a desktop PC's reset button. After pressing the reset button, the system will reboot automatically. DO NOT use the Reset button under normal conditions; use it only if the software is not working properly. To protect the integrity of data being transmitted or processed, you should always reset the system via the operating system using the software reboot function.

Real Time Clock (RTC)

The RKP-A110's real-time clock is powered by a lithium battery. You can easily replace the battery yourself using an optional battery kit. Refer Replacing the RTC Battery section for details. However, please note that there is a risk of explosion if the battery is replaced by an incorrect type of battery. Contact a qualified Moxa support engineer if you have any questions about the RTC battery.



ATTENTION

There is a risk of explosion if the battery is replaced by a battery of the incorrect type.

3. Hardware Connections

The RKP-A110 Series computers are compact and rugged, making them suitable for industrial applications. The LED indicators allow users to monitor performance and quickly identify trouble spots. Multiple ports are provided for connecting a variety of different devices. The RKP-A110 Series computers come with a reliable and stable hardware platform that lets you devote the bulk of your time to application development. This chapter describes the hardware installation and connector interfaces of the RKP-A110 computers.

Installing Rack-mounting Ears

The RKP-A110 computer comes preinstalled with two rack-mounting ears. If they are not, use the rack-mounting kit to install the ears. The rack-mounting kit includes 2 rack-mounting ears and 8 screws (size: M4x6), four for each mounting ear.

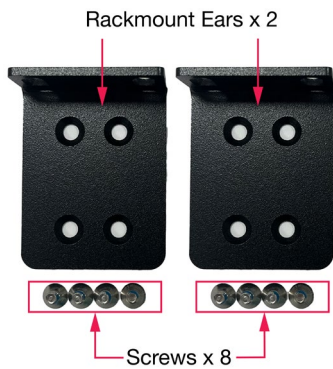

After installing the rack-mounting kit, do the following to install the computer on a rack.

Step 1.

If the mounting ears are not installed, use four screws each to attach the mounting ears on both sides of the computer.

Step 2:

Place the computer on a rack and use another four screws to secure the rack-mount ears to the rack.

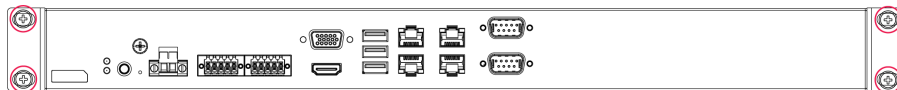

The second set of four screws needs to be purchased separately. Refer to the figure on the right for the specifications.

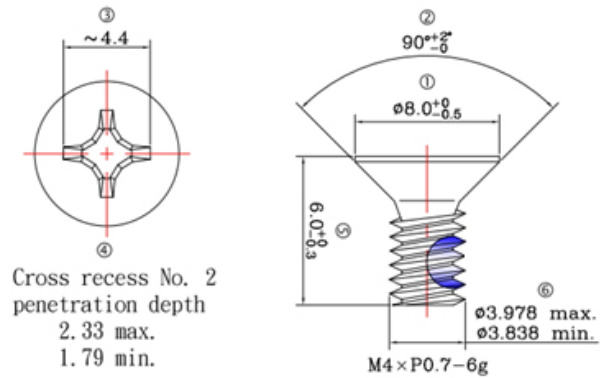

Connecting the Power

The RKP-A110 computers are provided with 2-pin power input connectors in a terminal block on the front panel. Insert the power-cord wires into the connectors and tighten them to secure the wires in place. Plug in the power cable to a power source. The power LED will light up to indicate that power is being supplied to the computer. It should take about 30 to 60 seconds for the operating system to complete the boot-up process.

Pin	Definition
1	V+
2	V-

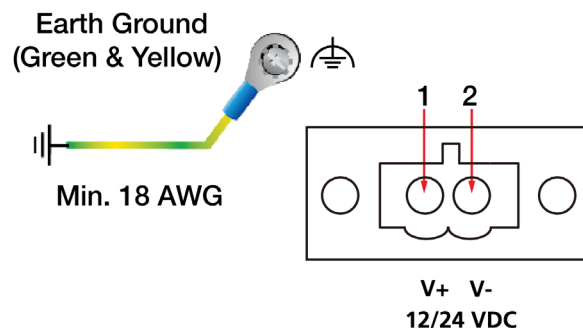

The power input specification is given below:

The DC power source rating is 12 VDC @ 5.4 A, or 24 VDC @ 2.6 A. An 18 AWG cable size DC power is suggested.



ATTENTION

This product is intended to be supplied by a Listed Power Supply with output marked LPS and rated to deliver 12 VDC at a maximum of 5.4 A, or 24 VDC at a maximum of 2.6 A, and minimum T_{ma}=60°C. If you need assistance with purchasing a power adapter, contact the Moxa technical support team.



ATTENTION

Before connecting the RKP-A110 computer to the DC power inputs, ensure that the DC power source voltage is stable.

- The wiring for the input terminal block shall be installed by qualified and experienced professionals.
 - Wire Type: Cu, FW2
 - Use 18-12 AWG wire size and a torque value of 0.5 N-m.
- Use only one conductor in a clamping point between the DC power source and the power input.



NOTE

If using Class I adapter, the power cord adapter should be connected to a socket outlet with an earthing connection or the power cord and adapter must comply with Class II construction.



NOTE

For surge protection, connect the grounding connector located below the power connector with the earth (ground) or a metal surface.

An 18 AWG cable size conductor must be used when the connection to the external grounding screw is utilized. The heat sink is grounded to the chassis by an internal screw.



WARNING

為避免電磁干擾，本產品不應安裝或使用於住宅環境。

Wiring Requirements

The following common safety precautions should be observed before installing any electronic device:

- Power wires and communication/signal wires should be routed through separate paths. If power and communication/signal wires must cross paths, make sure the wires are perpendicular at the intersection point.



NOTE

Do not run signal or communication wiring and power wiring in the same wire conduit. To avoid interference, wires with different signal characteristics should be routed separately.

- Use the type of signal transmitted through a wire to determine which wires should be bundled together and which ones should be kept separate. The rule of thumb is that wiring that carries similar electrical signals can be bundled together.
- When necessary, we strongly advise labeling the wiring for all devices in the system.



ATTENTION

Do not run signal or communication wiring and power wiring in the same wire conduit. To avoid interference, wires with different signal characteristics should be routed separately.



ATTENTION

Safety First!

Be sure to disconnect the power cord before installing and/or wiring your device.

Electrical Current Caution!

Calculate the maximum possible current in each power wire and common wire. Observe all electrical codes dictating the maximum current allowable for each wire size.

If the current goes above the maximum rating, the wiring could overheat, causing serious damage to your equipment.

Temperature Caution!

Be careful when handling the unit. When the unit is plugged in, the internal components generate heat, and consequently the outer casing may feel hot to the touch.



Restricted Access Location

This equipment is intended to be used in Restricted Access Locations, such as a computer room, with access limited to SERVICE PERSONAL or USERS who have been instructed on how to handle the metal chassis of equipment that is so hot that special protection may be needed before touching it. The location should only be accessible with a key or through a security identity system.

Ethernet Ports

The RKP-A110 has 4 or 12 Ethernet ports. When a LAN cable is properly connected, the LEDs on the front panel will glow to indicate the connection status.

The pin assignments are shown below:

Pin	10/100 Mbps	1000 Mbps
1	ETx+	TRD(0)+
2	ETx-	TRD(0)-
3	ERx+	TRD(1)+
4	-	TRD(2)+
5	-	TRD(2)-
6	ERx-	TRD(1)-
7	-	TRD(3)+
8	-	TRD(3)-

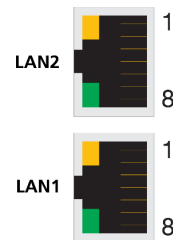

Serial Ports

The RKP-A110 comes with 2, 6, or 10 software-selectable RS-232/422/485 serial ports with DB9 connectors, which are located on the front panel. The pin assignments are shown below:

Pin	RS-232	RS-422	RS-485 (2-wire)
1	DCD	TxDA(-)	-
2	RxD	TxDB(+)	-
3	TxD	RxDB(+)	DataB(+)
4	DTR	RxDA(-)	DataA(-)
5	GND	GND	GND
6	DSR	-	-
7	RTS	-	-
8	CTS	-	-

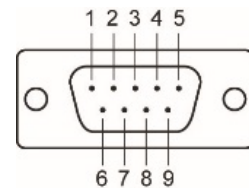

Digital Inputs/Digital Outputs

The RKP-A110 is provided with four digital inputs and four digital outputs in a terminal block. They are located on the front panel of the computer.

For pin definitions, see the figure below:

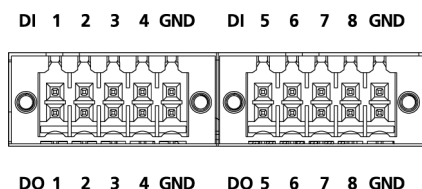

Digital Inputs

Dry Contact:

Logic 0: Short to Ground

Logic 1: Open

Digital Outputs

Current Rating:
200 mA per channel

Voltage:
0 to 24 VDC

For wiring methods, see the figure below:

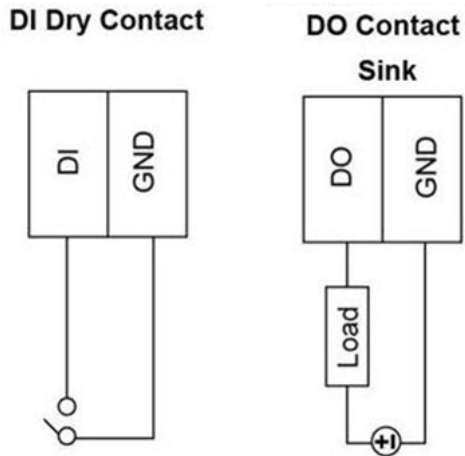

Connecting USB Devices

The RKP-A110 has 3 USB 3.0 Type-A connectors located on the front panel. The ports support keyboard and mouse devices and can also be used to connect a flash disk for storing large amounts of data.

Installing Storage Disks

The RKP-A110 comes with two storage slots that allow users to install two 2.5" SATA HDD/SSD. The slots are located on the rear panel of the computer.

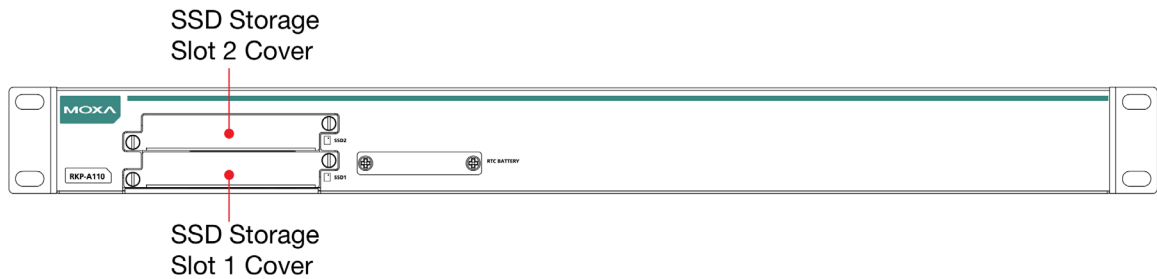

To install an SSD drive, do the following:

1. Unfasten the two screws on the storage slot.

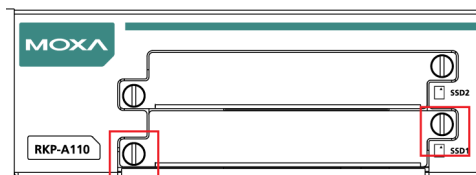

2. Pull out the storage tray and find the four screws included in the product package.



3. Place the storage disk on the tray.
Ensure that the storage disk aligns with the screws on the storage tray.



4. Reverse the storage tray and fasten four screws to secure the storage drive to the tray.



5. Insert the storage tray into the slot and secure the tray in place with two screws.



6. Use the same method to install a storage drive in the other slot.

Connecting to Displays

The RKP-A110 comes with an HDMI connector and a VGA connector located on the front panel, allowing users to connect to an audio or video device.



NOTE

Use HDMI-certified cables for a reliable audio or video connection.

Replacing the RTC Battery

The RKP-A110 computer comes with one slot for a battery on the bottom panel of the computer. A lithium battery (3 V / 200 mAh) is preinstalled in the slot.

To replace the battery, do the following:

1. Unfasten the two screws on the battery cover.

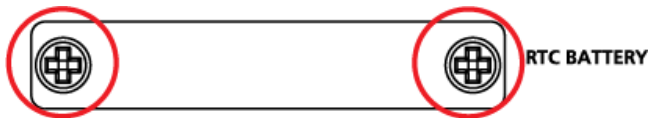

2. Take off the cover.
The battery is attached to the slot cover as indicated in the image.

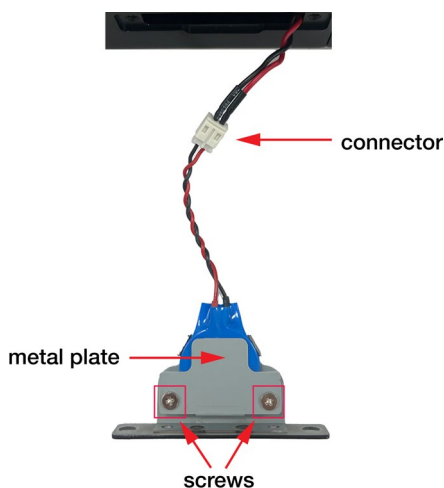

3. Unplug the connector of the battery-cover assembly from the internal wire of the slot.
4. Remove the two screws on the metal plate attached to the battery holder.



5. Place a new battery in the battery holder, replace the metal plate, and fasten the two screws on to the frame to secure the battery.

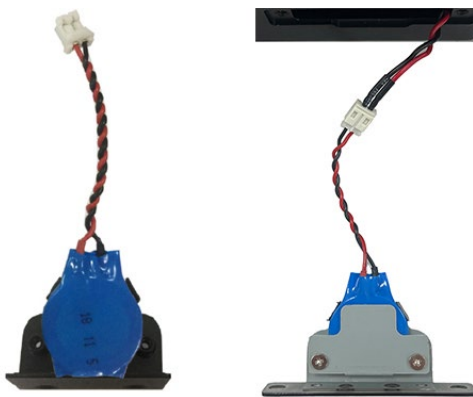

6. Plug in the connector of the battery-cover assembly to the internal wire of the slot.
7. Place the battery holder back in the slot and secure it by fastening the two screws on the cover.



WARNING

Be sure to use the correct type of battery. Incorrect battery may cause system damage. Contact Moxa's technical support staff for assistance, if necessary.

To reduce the risk of fire or burns, do not disassemble, crush, or puncture the battery; do not dispose of in fire or water and do not short external contacts.

4. BIOS Setup

This chapter describes the BIOS settings of the RKP-A110 computer. The BIOS is a set of input/output control routines for peripherals, which are used to initialize system peripherals before the operating system is loaded. The BIOS setup allows the user to modify the system configurations of these peripherals' basic input/output interfaces.

Entering the BIOS Setup

To enter the BIOS setup utility, press the **F2** key while the system is booting up. The main **BIOS Setup** screen is shown with the following options:

- **Continue:** Continue to boot up
- **Boot Manager:** Select the device for booting up
- **Device Management:** Enter the device configuration menu
- **Boot From File:** Select the UEFI boot up file
- **Administer Secure Boot:** Enter the Secure Boot menu
- **Setup Utility:** Enter the BIOS configuration menu

Select **F2** to enter the **BIOS configuration**.

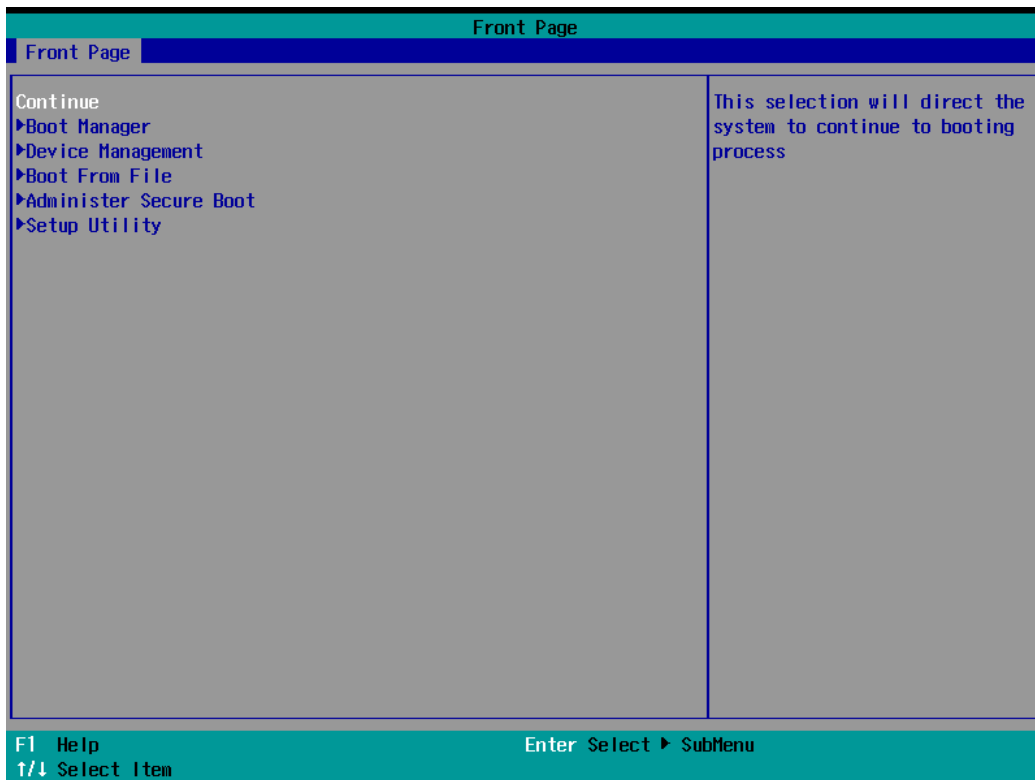

When you enter **Setup Utility**, a basic description of each function key is listed at the bottom of the screen.

F1	General Help	↑ ↓ .	Select Item
F5/ F6	Change Values	← →	Select Menu
F9	Setup Defaults	ESC	Exit
F10	Save and Exit	EN TER	Select or go to Submenu.

The BIOS configuration screen will be shown when you enter the **Setup Utility** option, as shown in the following figure.

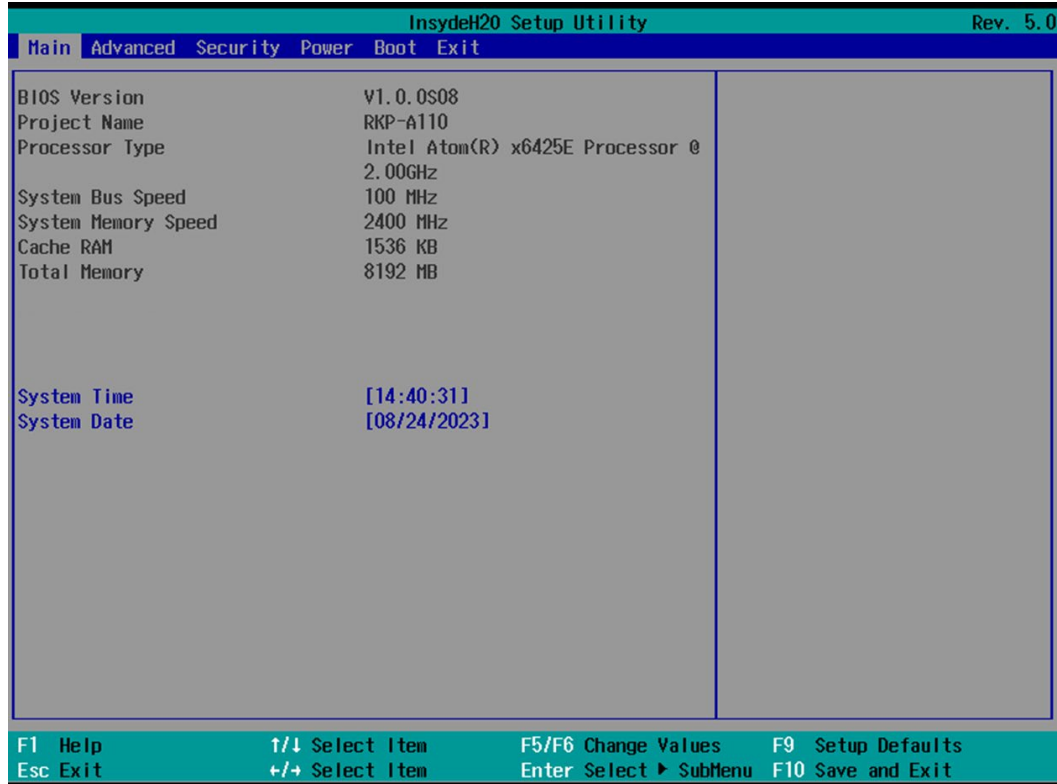

NOTE

The **Processor Type** information will vary depending on the computer model that you have purchased.

Main Page

The **Main** page displays basic system hardware information, such as model name, BIOS version, and CPU type.

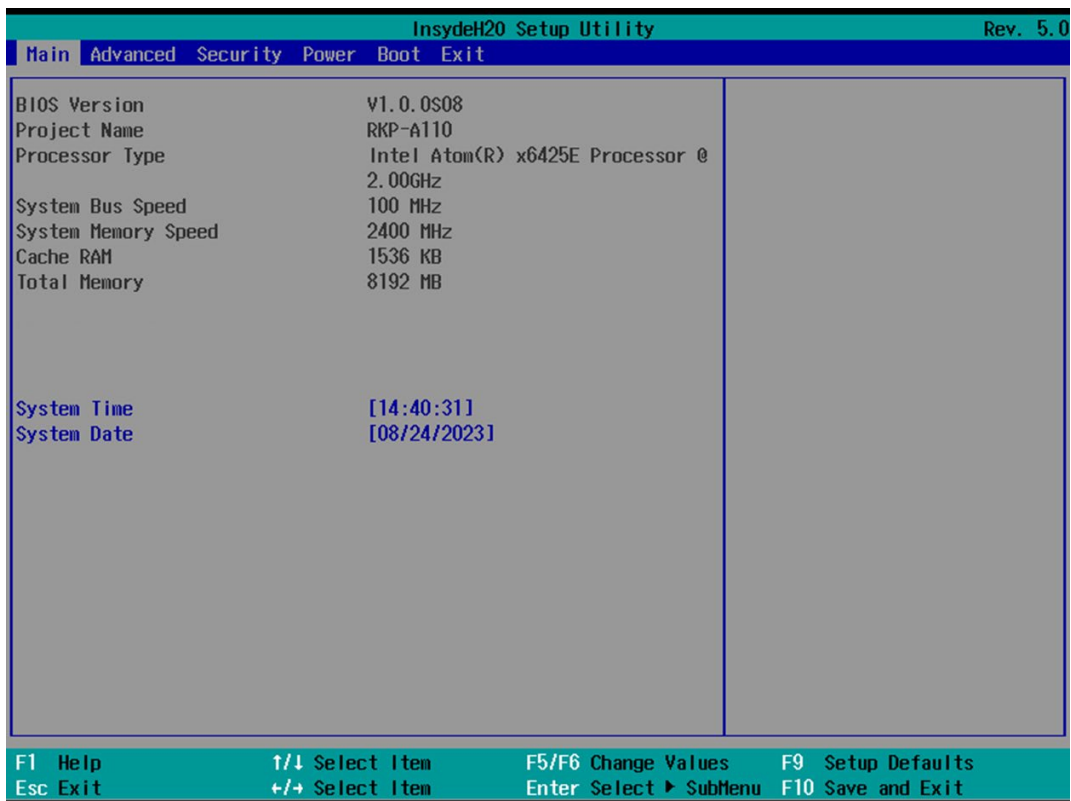

Advanced Settings

Select the **Advanced** tab in the BIOS setup utility to open the advanced features screen.

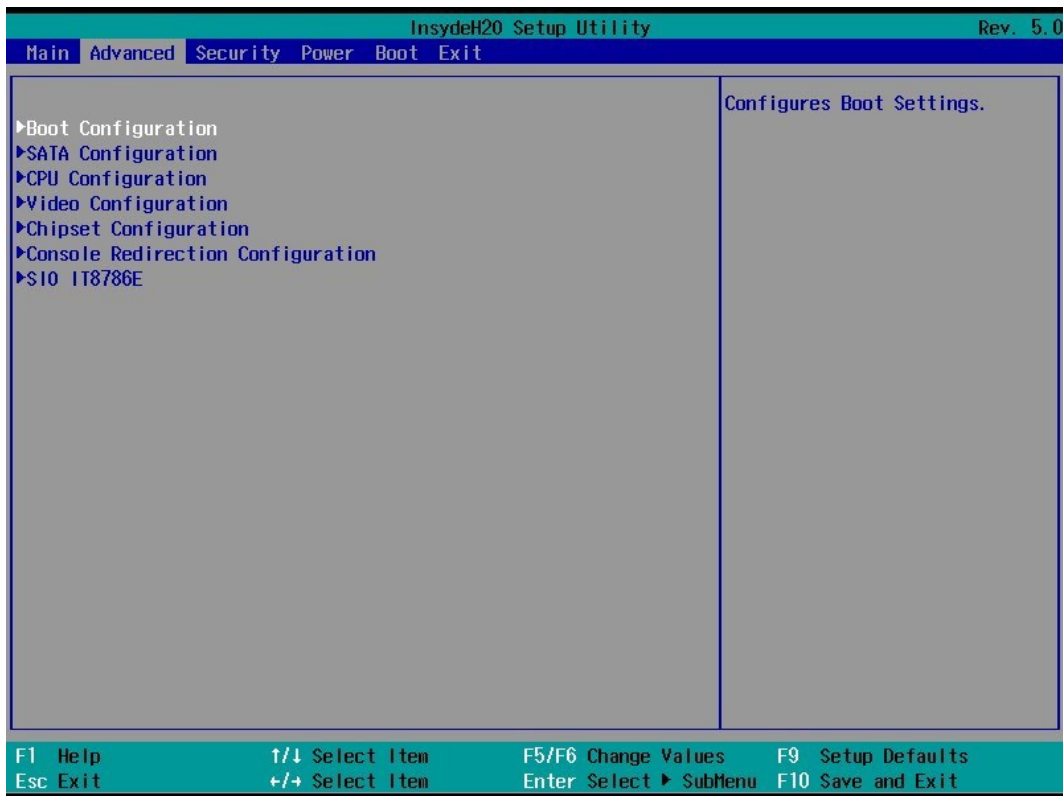

Boot Configuration

This item allows users to configure the default value of Numlock value.

Options: On (default), Off.

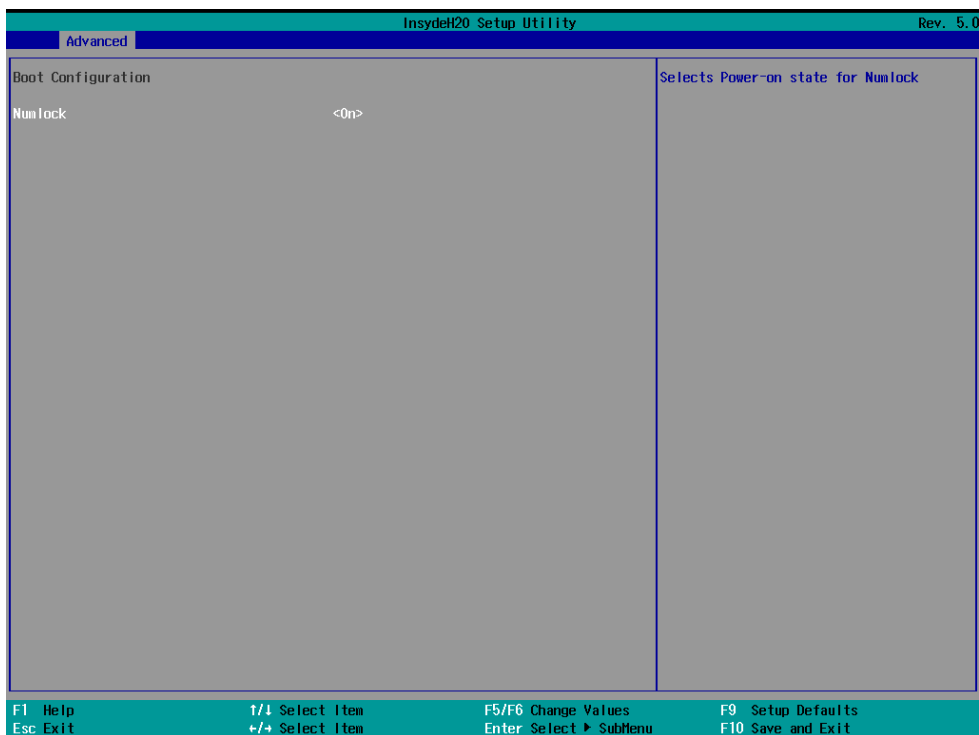

SATA Configuration

This section allows you to select the SATA speed limit and hot plug setting.

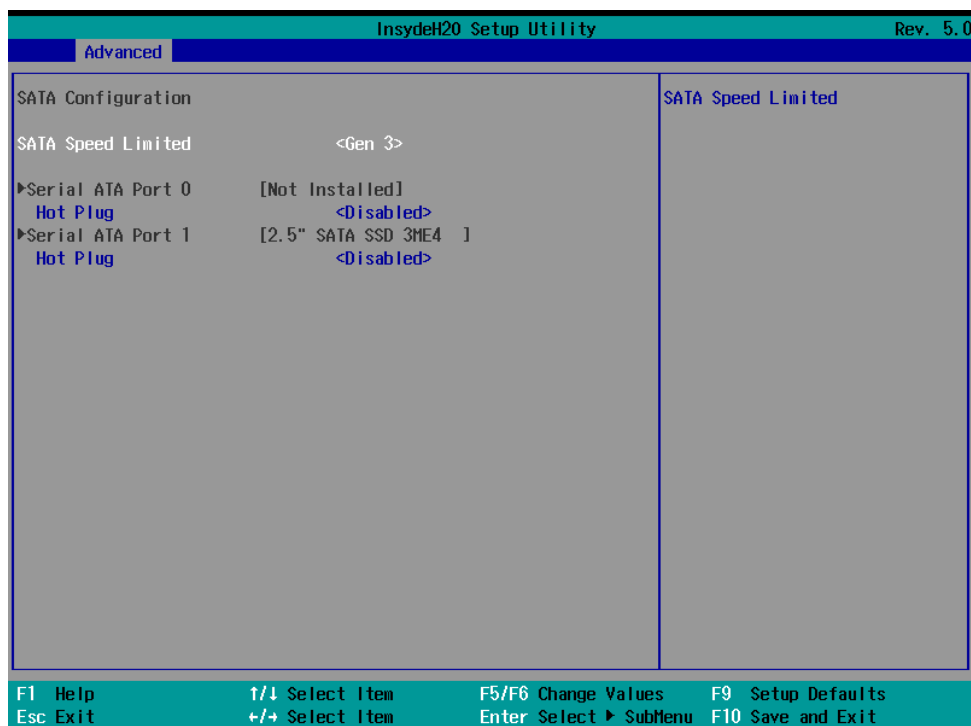

SATA Speed Limited

Options: Gen 1, Gen 2, Gen 3 (default)

Serial ATA Port

This setting displays information on the drives installed on your computer.

SATA Port—Hot Plug

This item allows you to enable/disable hot-plugging capabilities (the ability to remove the drive while the computer is running) for the storage drives installed.

Options: Disabled (default for Port 0), Enabled (default for Port 1 and Port 2)

CPU Configuration

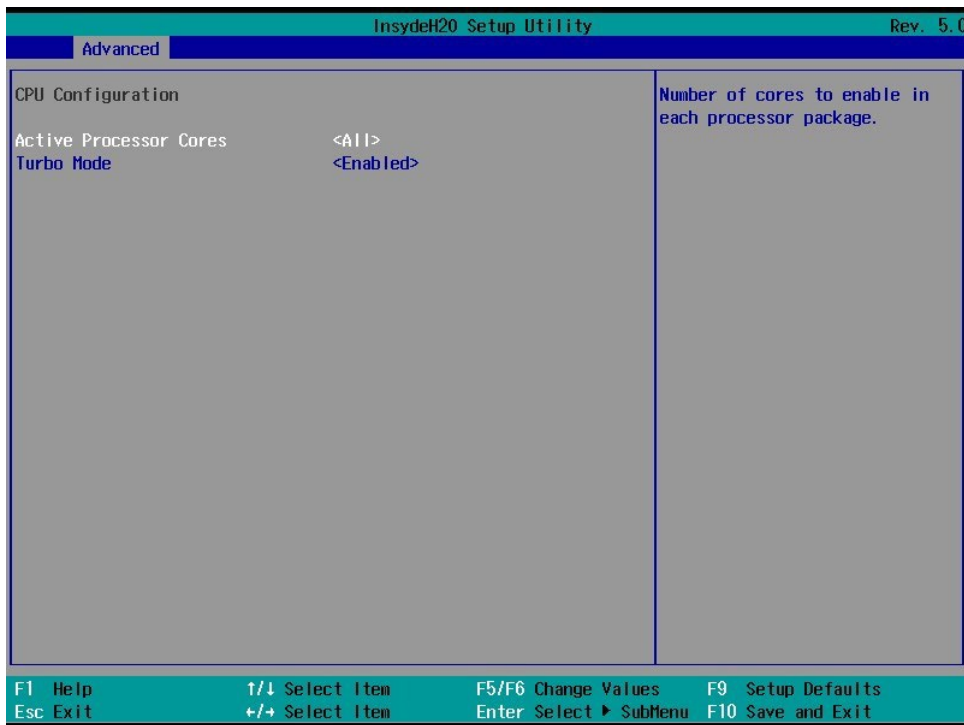

Active Processor Cores

This item indicates the number of cores that can be enabled in each processor package.

Turbo Mode

Enable/Disable processor Turbo Mode (requires EMTTM enabled too). AUTO means enabled, unless max turbo ratio is bigger than 16.

Options: Disabled, Enabled (default)

Video Configuration

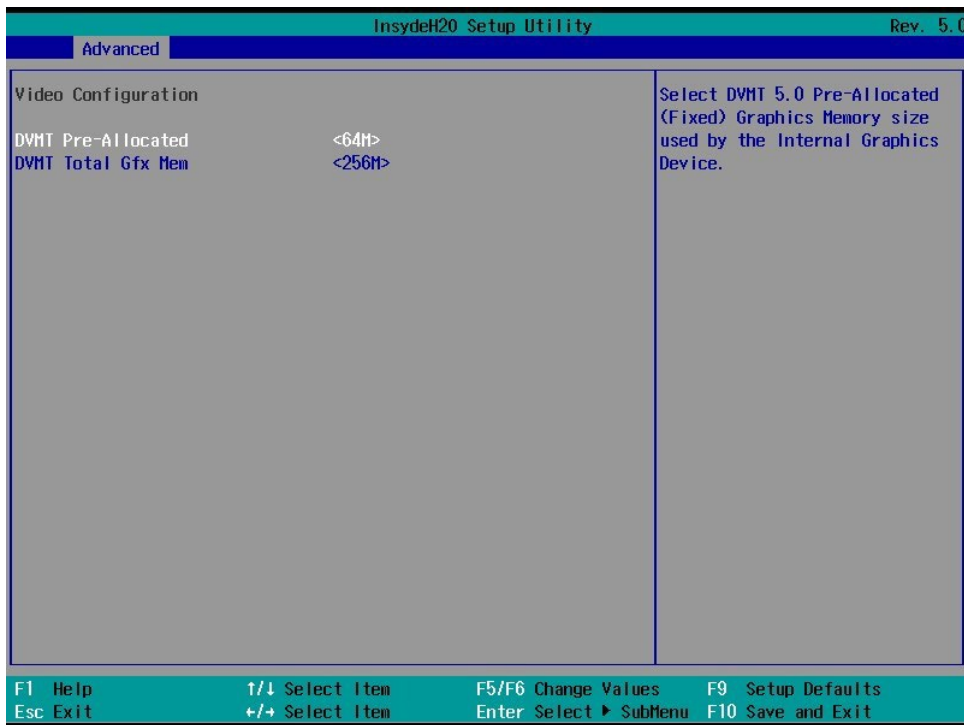

DVMT Pre-Allocated

Selecting this option allows you to configure pre-allocated memory capacity for the IGD. Pre-allocated graphics memory is invisible to the operating system.

Options: 64M (default), 96M, 128M, 160M

DVMT: The amount of video memory your computer has is dependent on the amount of pre-allocated memory set for your system plus the Dynamic Video Memory Technology (DVMT). DVMT dynamically allocates system memory for use as video memory creating the most efficient use of available resources for maximum 2D/3D graphics performance.

DVMT Total Gfx Mem

This option allows you to configure the maximum amount of memory DVMT will use when allocating additional memory for the internal graphics device.

Options: 256 MB (default), 128 MB, Max.

Chipset Configuration

This option allows you to configure the chipset settings.

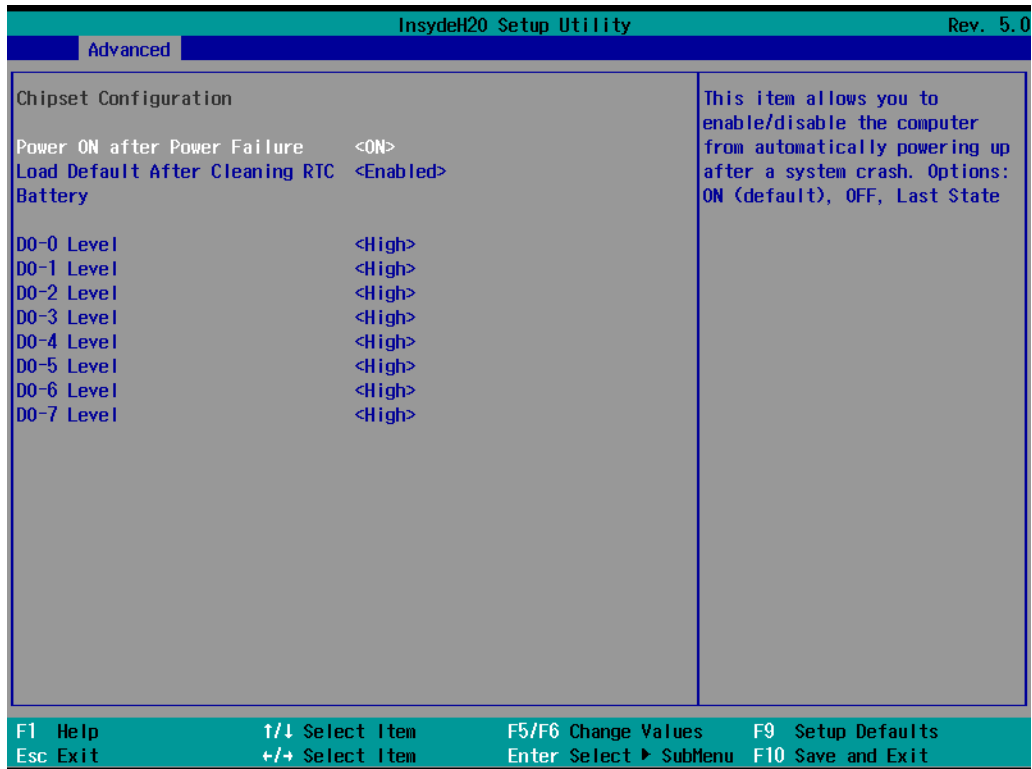

Power ON after Power Failure

This option allows you to enable/disable the computer from automatically powering up after system power is re-enabled.

Options: ON (default), OFF, Last State

Load Default After Cleaning RTC Battery

System will load default when detecting RTC battery loss.

Options: Disabled, Enabled (default)

DO-0-7 Level

This option allows users to set the DO-0 to DO-7 level.

Options: High (default), Low

Console Redirection

This section allows you to configure the console redirection settings.

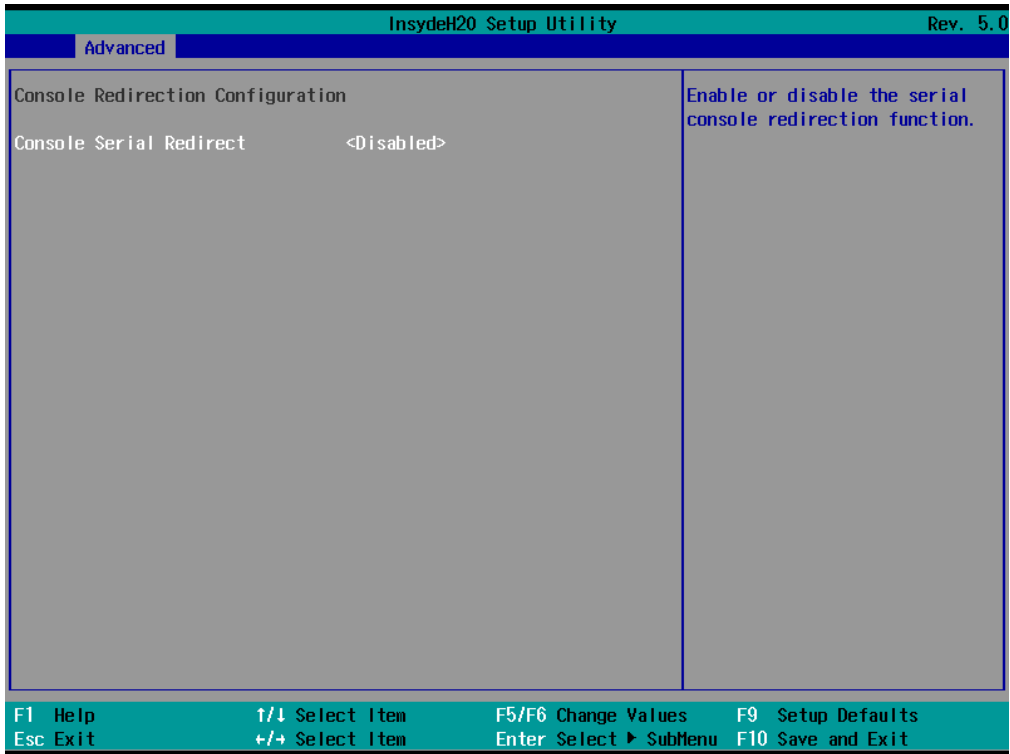

Console Serial Redirect

When the Console Redirection Function is enabled, the console information will be sent to both the display monitor and the serial port (COM1).

Options: Disabled (default), Enabled

SIO ITE8786E

This option allows users to configure serial port settings.

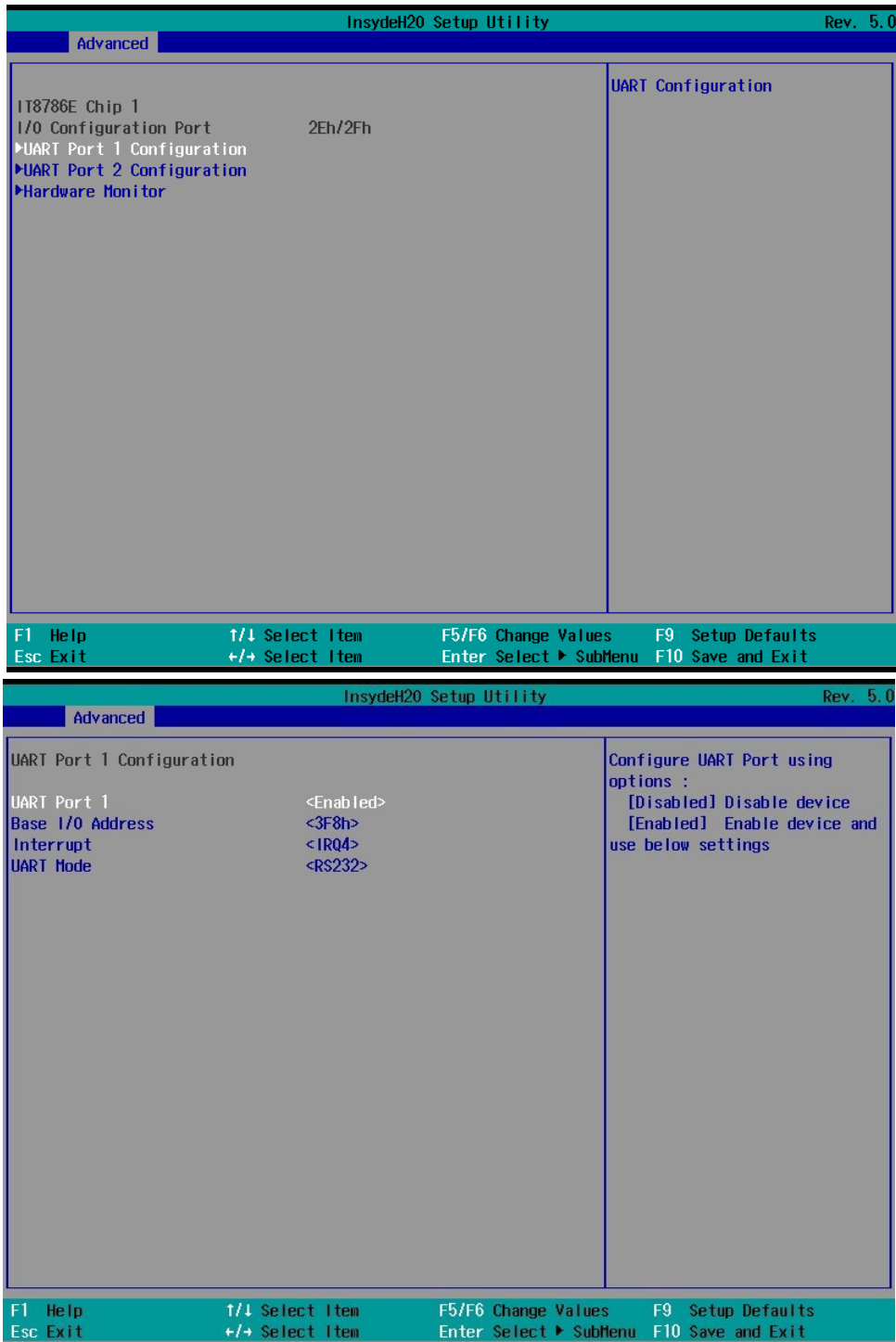

UART Port 1

This function allows users to configure the resources for serial port 1.

Disable: Disables the serial port A connection.

Enable: Enables the Serial Port A connection (default)

UART Port 2

This function allows users to configure the resources for serial port 2.

Disable: Disables the serial port B connection.

Enable: Enables the Serial Port B connection (default)



NOTE

The other UART ports can only be configured by the OS utility.

Hardware Monitor

This option allows users to view stats on the computer such as CPU and system temperature, voltage levels, and other chipset information.

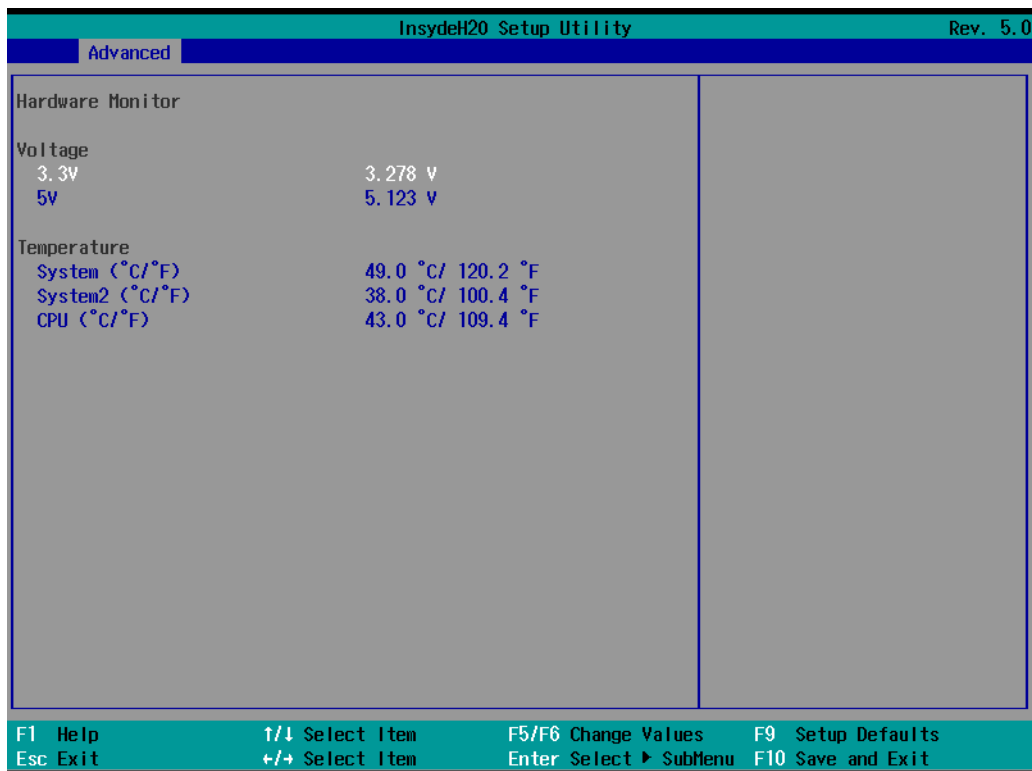

Security Settings

The **Security** page includes security-related settings. You will require the supervisor password and user password.

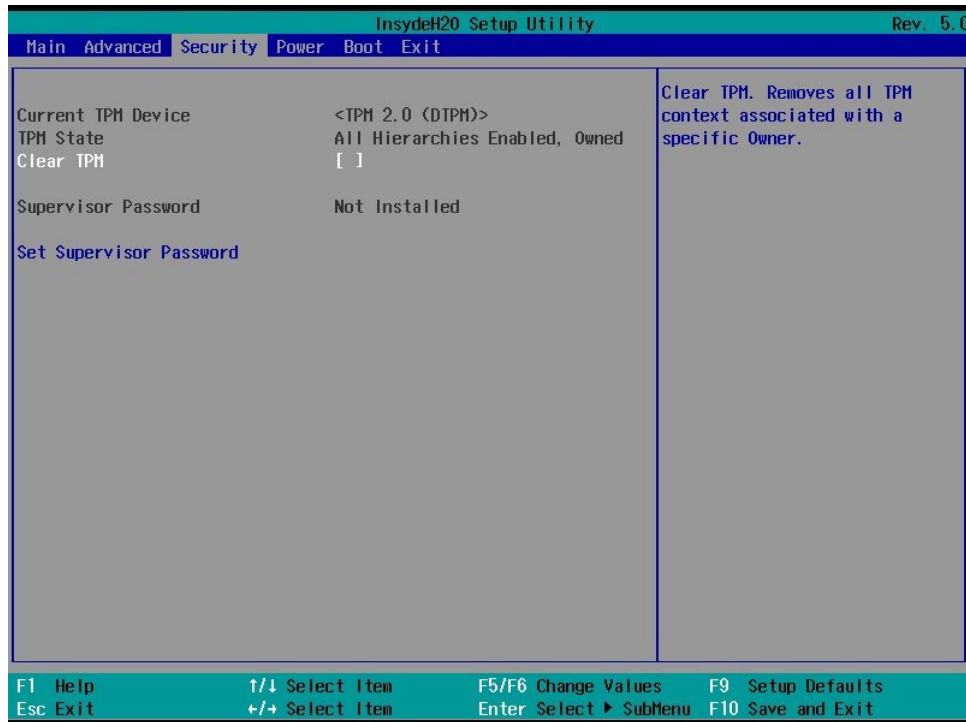

Current TPM Device

This item indicates if the system has a TPM module configured and provides information on its type.

TPM State

This item allows users to view the current TPM settings.

Clear TPM

This item allows users to remove all TPM context associated with a specific owner.

Set Supervisor Password

This item allows you to set the supervisor password. To set the password, select the **Set Supervisor Password** option, enter the password, and re-confirm the password.

To delete the password, select the **Set Supervisor Password** option and enter the old password; leave the new password fields blank, and then press enter.

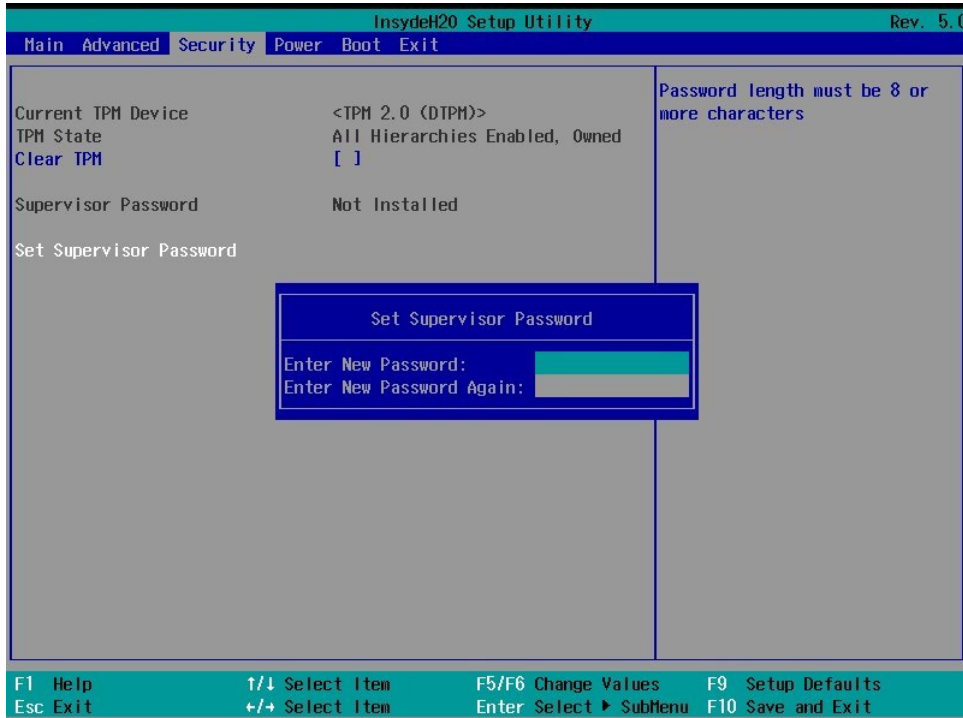

After setting the supervisor password, users can choose when the input password screen will pop up.

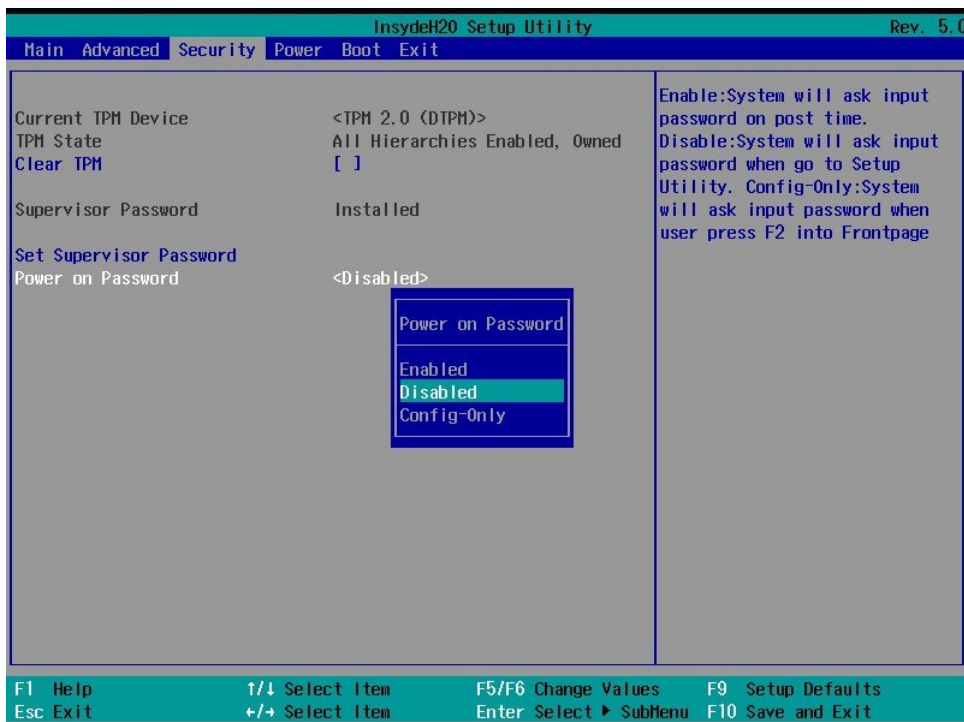

Enable: System will ask input password during post time.

Disable: System will ask for the password to go to the setup utility.

Config Only: System will only ask for the password when you select the config (F2) option

Power Settings

The Power page allows users to configure the power settings of the computer.

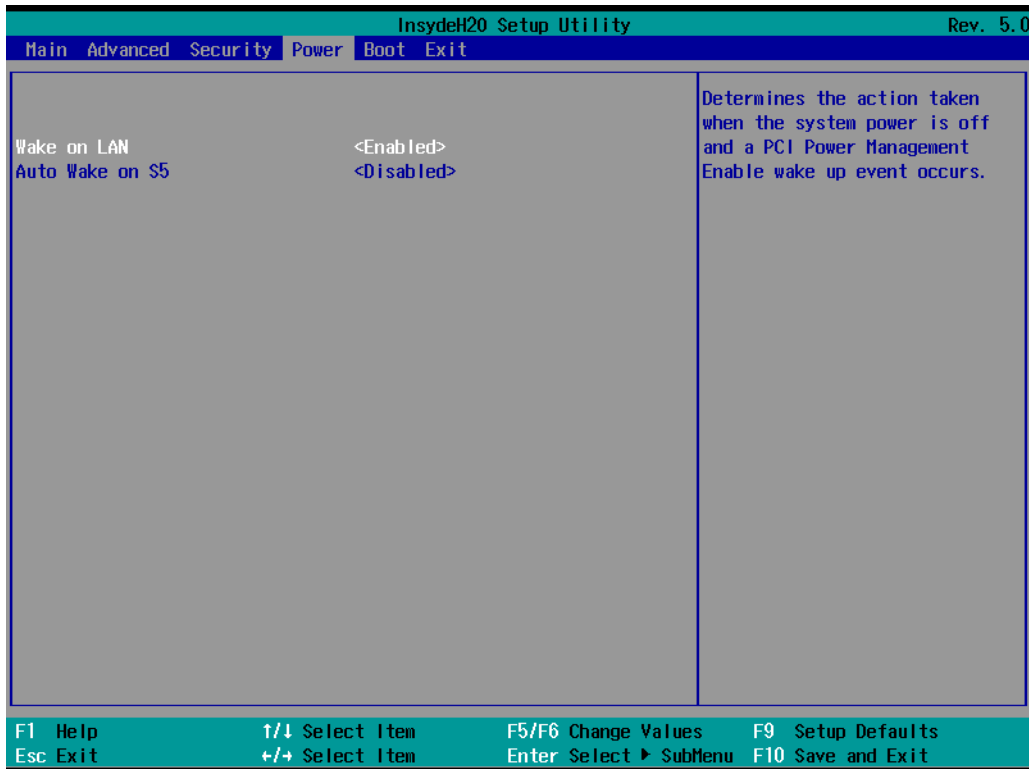

Wake on LAN

Enable this feature if you want to wake up the system by a LAN device from a remote host.

Options: Enabled (default), Disabled

Auto Wake on S5

This option allows you to configure the computer to wake from S5 status. S5 stands for Soft Off, where the PSU remains engaged but power to all other parts of the system is cut. Auto wake on S5 schedules a soft reboot at certain periodic times that may be specified in the BIOS.

Options: Disabled (default); By Every Day (user specifies a regular daily time when the computer will power up); By Day of Month (user specifies a regular day each month when the computer will power up)

Boot Settings

The **Boot** page includes configuration settings for the boot-up process.

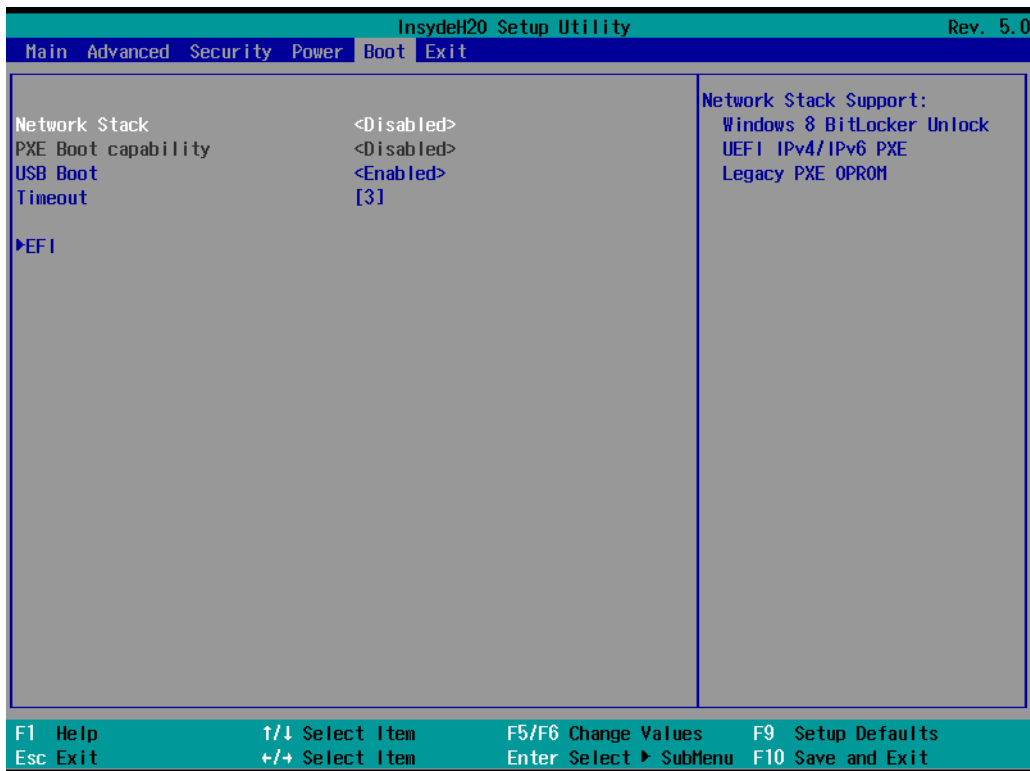

NOTE

If you have not added any storage to your computer, you will not see the EFI option.

Network Stack

This option is used to deploy an Internet Protocol (IP) stack. The IP stack provides an application library to open/close connections to remote devices and send/receive data between the remote devices.

Options: Disabled (default), Enabled

PXE Boot capability

PXE Booting is booting a system over a network. This option allows users to start PXE over IPv4 or IPv6

Options: Disabled (default), UEFI: IPv4, UEFI: IPv6, UEFI: IPv4/IPv6

USB Boot

Used to enable or disable boot-up from USB devices.

Options: Enabled (Default), Disabled

Timeout

This item allows users to set the number of seconds that the firmware will wait before booting with the original default boot option.

EFI

This option allows users to select the boot order. Use F5 (move down) or F6 (move up) to change the value.

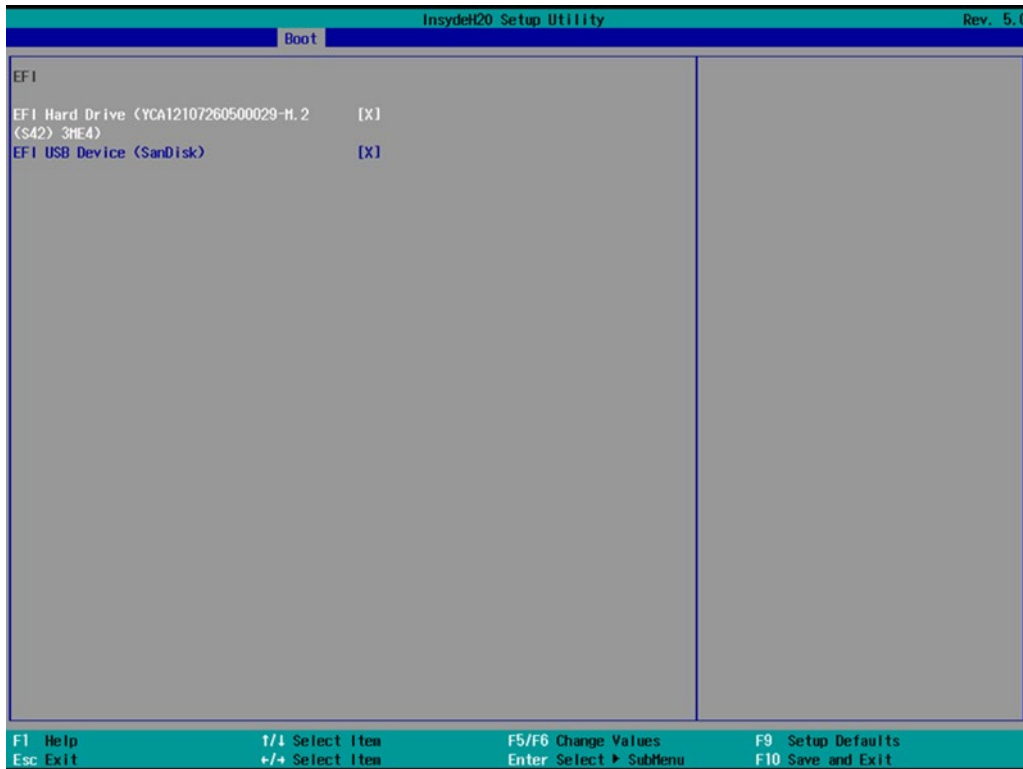

Exit Settings

The **Exit** page includes options to exit the BIOS environment.

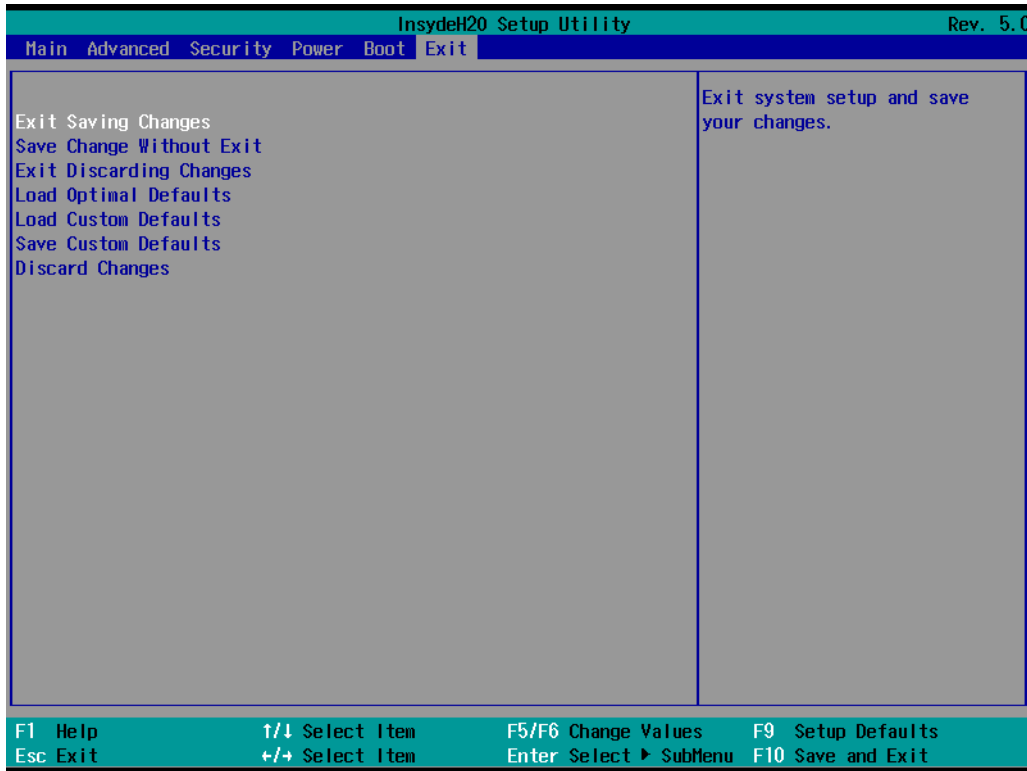

Exit Saving Changes

This option allows you to exit the BIOS environment and save the values you have just configured.

Options: Yes (default), No

Save Change Without Exit

This option allows you to save changes without exiting the BIOS environment.

Options: Yes (default), No

Exit Discarding Changes

This option allows you to exit without saving any changes that might have been made to the BIOS.

Options: Yes (default), No

Load Optimal Defaults

This option allows you to revert to the factory default BIOS values.

Options: Yes (default), No

Load Custom Defaults

This option allows you to load custom default values for the BIOS settings.

Options: Yes (default), No

Save Custom Defaults

This option allows you to save the current BIOS values as a custom default that may be reverted to at any time by using the **Load Custom Defaults** option.

Options: Yes (default), No

Discard Changes

This option allows you to discard all settings you have just configured.

Options: Yes (default), No

Administering Secure Boot

Press F2 to go to the Administer Secure Boot.



Secure Boot helps computers resist attacks and infection from malware. The feature defines an interface between the operating system and BIOS. It detects tampering with boot loaders, key operation system files, and unauthorized option ROMs by validating their digital signatures.

Enabling UEFI Secure Boot

Set as "enabled" in "Restore Secure Boot to Factory Settings" under Administer Secure Boot menu. Press F10 as save and exist.



Moxa has put Microsoft key in BIOS in default; if users cannot boot up using a non-Windows OS, use the following example.

Enroll EFI Image

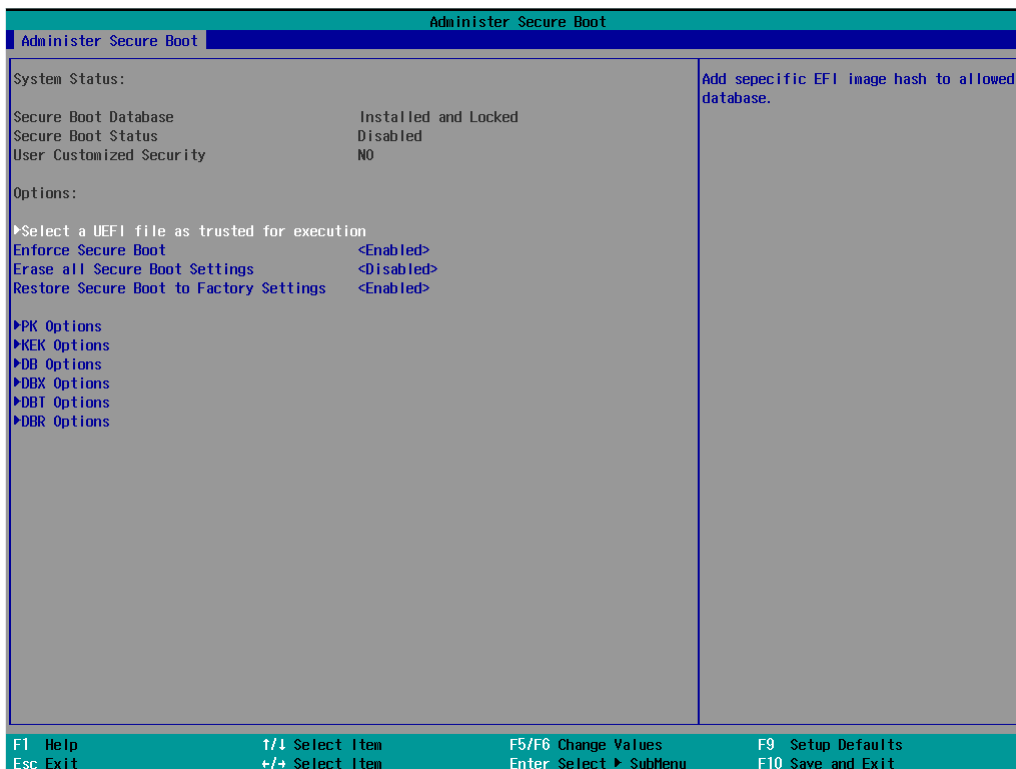

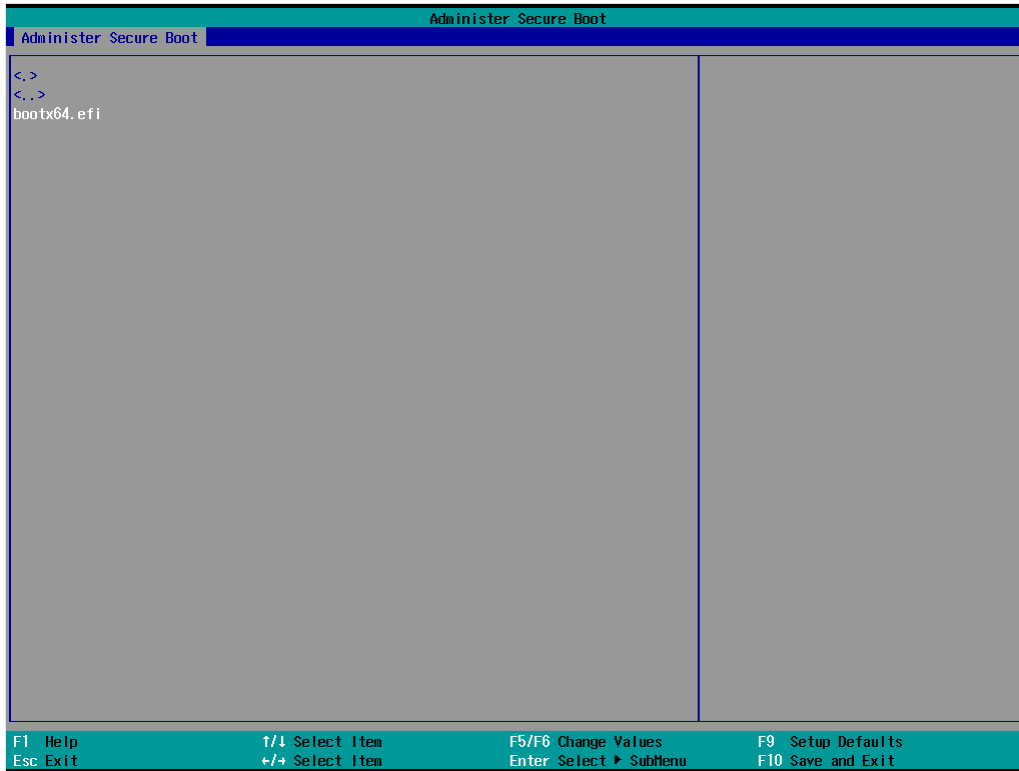

Enter "Administer Secure Boot" once again and see "Select a UEFI file as trusted for execution", put loader into the database named and followed by the UEFI standard \EFI\BOOT\BOOT{machine type short-name}. E.g., efi\boot\BootX64.efi, Debian (EFI\debian\grubx64.efi), Suse (EFI\opensuse\grubx64.efi)

Enroll Customer Key

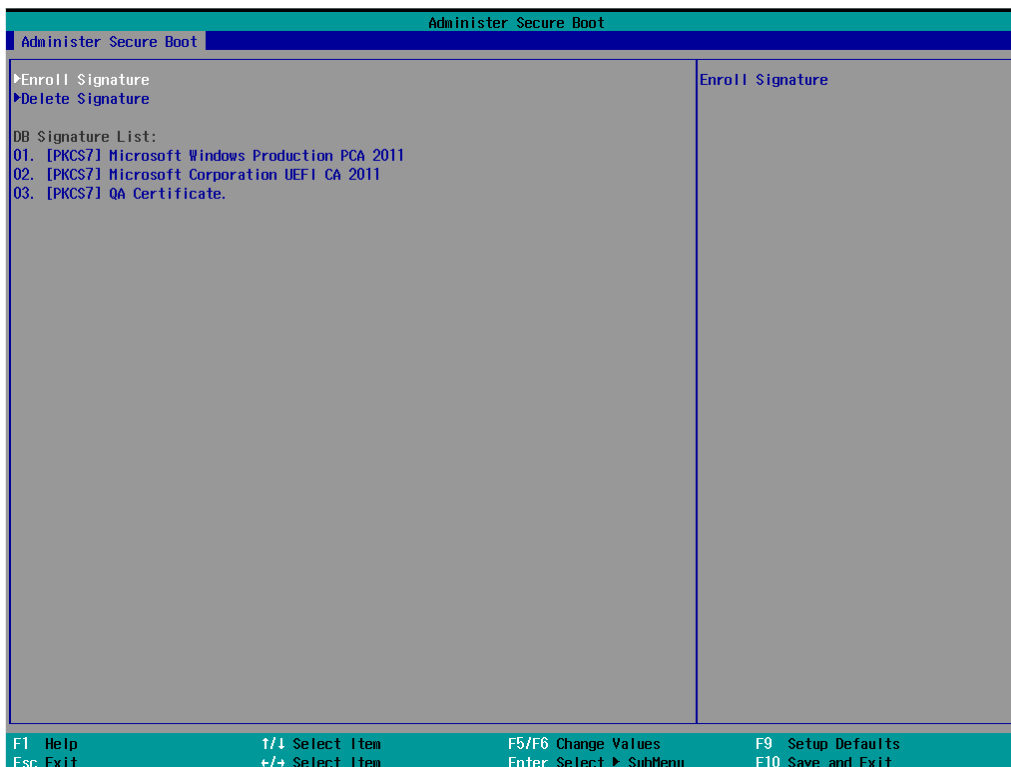
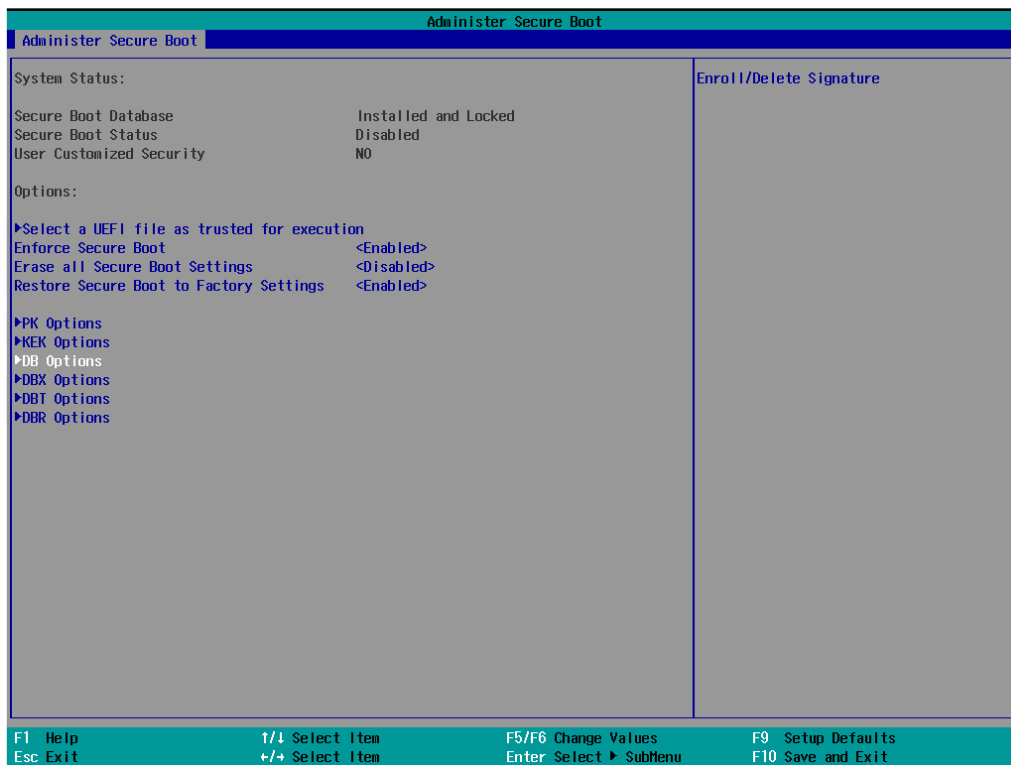

Enter "DB OPTION" and enroll your key. Please make sure your key is CRT format and uses RSA 2048 or better.

Upgrading the BIOS

This section describes how to upgrade the BIOS on your computer.



NOTE

Incorrect BIOS updates may permanently damage the computer. We strongly recommend that you contact the Moxa technical support team for assistance in obtaining all the necessary tools and the most current information before attempting to upgrade the BIOS on any Moxa device.

Step 1: Create a Bootable USB Disk

Before upgrading the BIOS, you must create a bootable USB drive for the system.

1. Insert a USB disk in the computer's USB drive.
2. Search for "format" and select **Create and format hard disk partitions**.

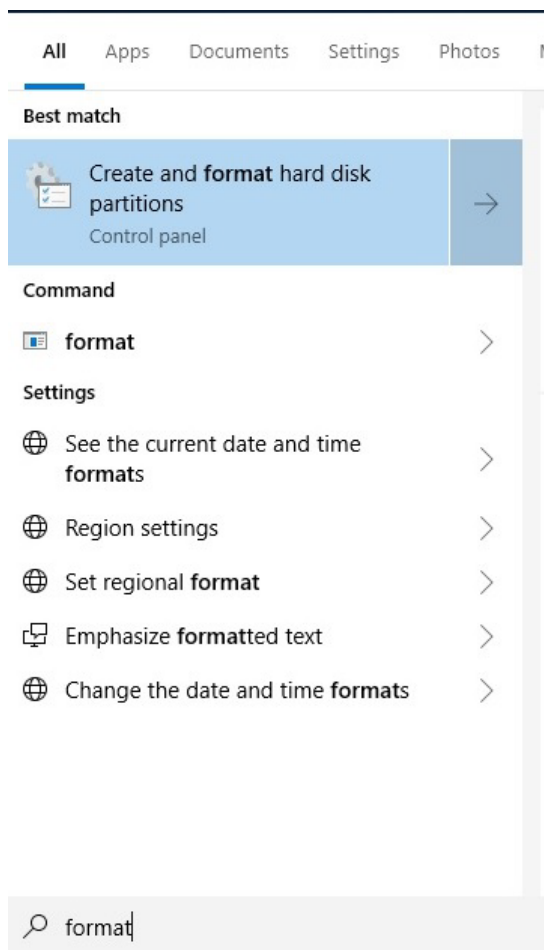

3. Right click on the USB disk and select **Format**.

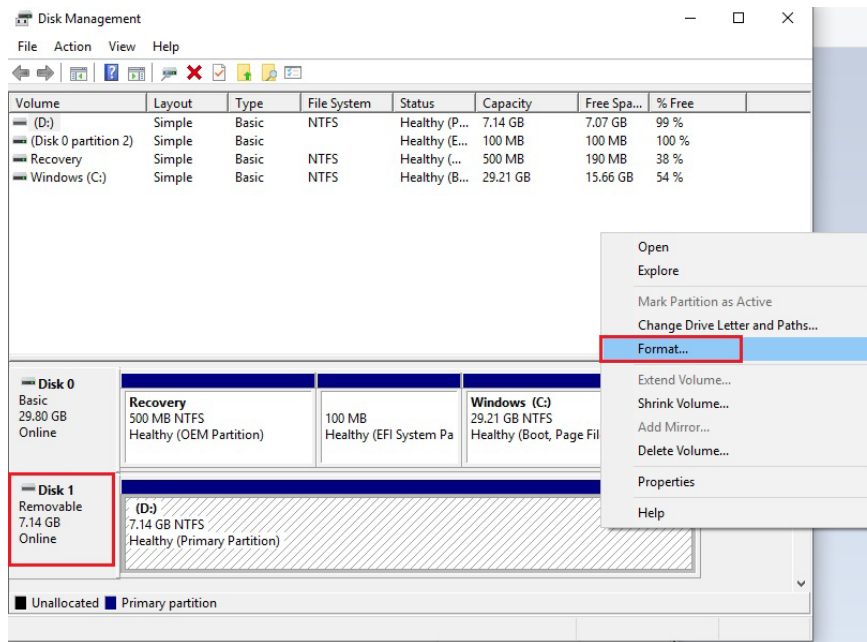

4. Select **FAT32** for the **File System** and click **OK** to start formatting the USB disk.

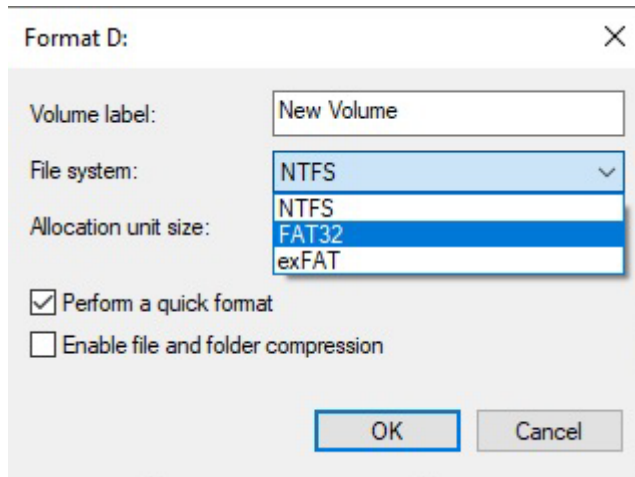

Step 2: Prepare the Upgrade File

You must use the BIOS upgrade installation file to upgrade the BIOS. Contact Moxa's technical department for assistance.

1. Get the BIOS upgrade file (includes an **efi** folder and an **xxxx.efi** file)
2. Copy the **efi** folder and **xxxx.efi** file to the bootable USB disk.

Step 3: Run the Upgrade Program on the Computer

1. Reboot the computer from the USB device and press **F2** while it is booting up to go to the Boot Manager.

If the BIOS does not recognize the USB device as the boot device, the USB device may not have a partition table. Use the Windows command line tool **diskpart** to rebuild the partition table.

2. Select the USB disk to boot from.



The screen will switch to the SHELL environment.

3. Type **fs0:**, then go to the directory where the upgrade file is located and type **xxxxxx.efi** (the name of the file is based on the upgrade file you get from Moxa).

```
Device mapping table
fs0      :Removable HardDisk - Alias hd24s0b blk0
         PciRoot(0x0)/Pci(0x14, 0x0)/USB(0x12, 0x0)/HD(1, MBR, 0x00DD3D80, 0x3F, 0xEB5FC1)
blk0     :Removable HardDisk - Alias hd24s0b fs0
         PciRoot(0x0)/Pci(0x14, 0x0)/USB(0x12, 0x0)/HD(1, MBR, 0x00DD3D80, 0x3F, 0xEB5FC1)
blk1     :Removable BlockDevice - Alias (null)
         PciRoot(0x0)/Pci(0x14, 0x0)/USB(0x12, 0x0)
hd24s0b  :Removable HardDisk - Alias fs0 blk0
         PciRoot(0x0)/Pci(0x14, 0x0)/USB(0x12, 0x0)/HD(1, MBR, 0x00DD3D80, 0x3F, 0xEB5FC1)

Shell> fs0:
fs0:\> xxxxxxx.efi
```

4. The upgrade program will run automatically. Wait for the process to complete.



ATTENTION

Do NOT switch off the power supply during the BIOS upgrade, since doing so may cause the system to crash.

- When the upgrade is done, the computer will automatically reboot. You can check the BIOS version on the Main page.

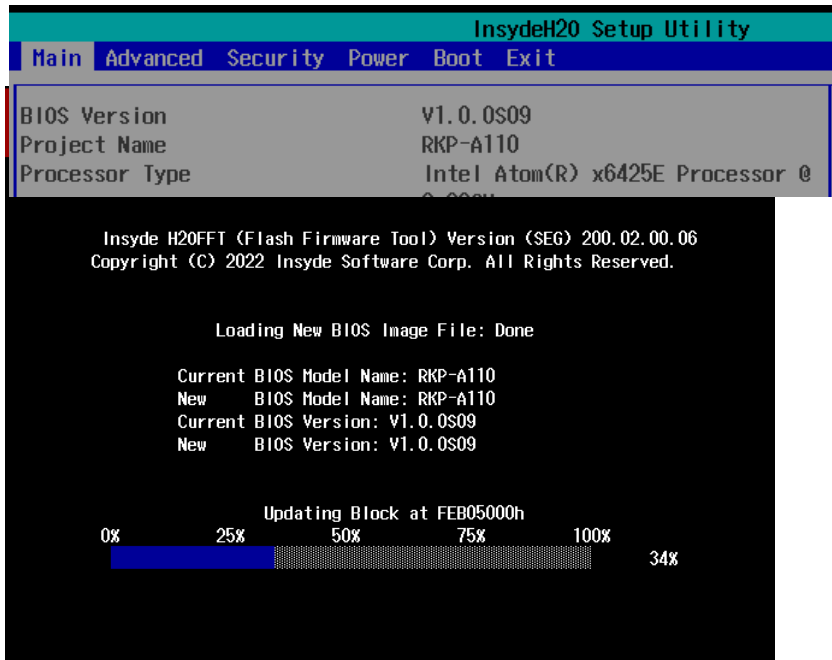

If the system has more than one boot device, you will see more than one fsx (x represents the number of devices).

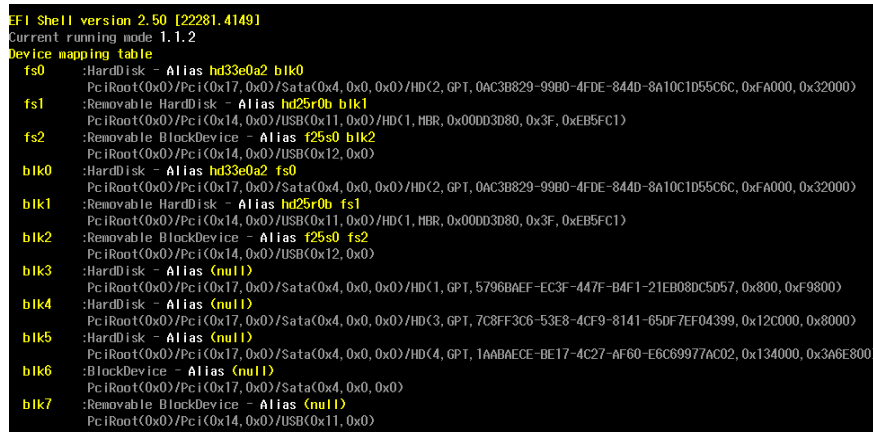

- Access each device path **fsx** (x is the device index), then type **ls** to view the content of the boot device until you locate the upgrade file and run it.

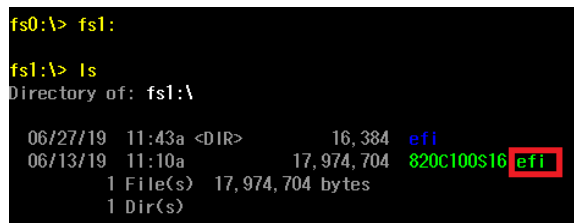

A. Safety Installation Instructions

A. RTC Battery Warning



ATTENTION

There is a risk of explosion if the wrong type of battery is used. To avoid this potential danger, always be sure to use the correct type of battery. Contact the Moxa RMA service team if you need to replace your battery.

Caution

There is a risk of explosion if the battery is replaced by an incorrect type. Dispose of used batteries according to the instructions on the battery.

B. Fuse Warning

CAUTION: For continued protection against fire, replace only with the same type and rating of fuse.

C. Rack-mounting Warning

The following or similar rack-mounting instructions are included with the installation instructions:

- (1) Elevated Operating Ambient:** If installed in a closed or multi-unit rack assembly, the operating ambient temperature of the rack environment may be greater than the room ambient temperature. Therefore, consideration should be given to installing the equipment in an environment compatible with the maximum ambient temperature (T_{ma}) specified by the manufacturer.
- (2) Reduced Air Flow:** Installation of the equipment in a rack should be such that the amount of air flow required for safe operation of the equipment is not compromised.
- (3) Mechanical Loading:** Mounting of the equipment in the rack should be such that a hazardous condition is not achieved due to uneven mechanical loading.
- (4) Circuit Overloading:** Consideration should be given to the connection of the equipment to the supply circuit and the effect that overloading of the circuits might have on overcurrent protection and supply wiring. Appropriate consideration of equipment nameplate ratings should be used when addressing this concern.
- (5) Reliable Grounding:** Reliable grounding of rack-mounted equipment should be maintained. Particular attention should be given to supply connections other than direct connections to the branch circuit (e.g., by using power strips).