

EDS-600 Series Quick Installation Guide

Moxa EtherDevice™ Switch

Version 5.4, July 2021

Technical Support Contact Information
www.moxa.com/support

MOXA®

© 2021 Moxa Inc. All rights reserved.

P/N: 1802006000018



Package Checklist

The Moxa EDS-600 Series is shipped with the following items. If any of these items is missing or damaged, please contact your customer service representative for assistance.

- 1 EDS-600 EtherDevice Switch
- RJ45 to DB9 console port cable
- Protective caps for unused ports (Only for EDS-611 Series and EDS-619 Series)
- Wall mounting kit (optional—must be ordered separately)
- Anti-vibration wiring kit (optional, must be ordered separately)
- Quick installation guide (printed)
- Warranty card

Features

Advanced Industrial Networking Capabilities

- IPv6 ready (certified by the IPv6 Logo Committee).
- IEEE 1588 PTP V2 (Precision Time Protocol) for precise time synchronization of networks.
- Supports LLDP (Link Layer Discovery Protocol)
- DHCP Option 82 for IP address assignment with different policies.
- Supports Modbus/TCP industrial Ethernet protocol.
- Turbo Ring and Turbo Chain (< 20 ms recovery time) and STP/RSTP.
- IGMP snooping and GMRP for filtering multicast traffic.
- Port-based VLAN, IEEE 802.1Q VLAN, and GVRP to ease network planning.
- QoS (IEEE 802.1p/1Q) and TOS/DiffServ to increase determinism.
- Port Trunking for optimal bandwidth utilization.
- IEEE 802.1X, HTTPS, and SSH to enhance network security.
- SNMPv1/v2c/v3 for different levels of network management.
- RMON for efficient network monitoring and proactive capability.
- Bandwidth management prevents unpredictable network status.
- Lock port function for blocking unauthorized access based on MAC address.
- Port mirroring allows for online debugging.
- Automatic warning by exception through e-mail and relay output.
- Digital inputs to integrate sensors and alarms with IP networks.

Panel Views of the EDS-608

Front View

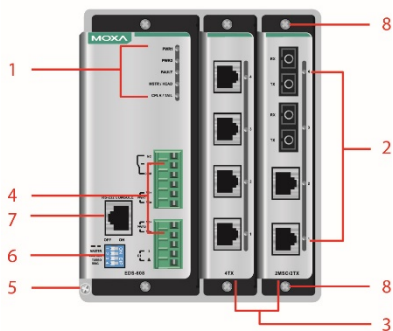

Rear View

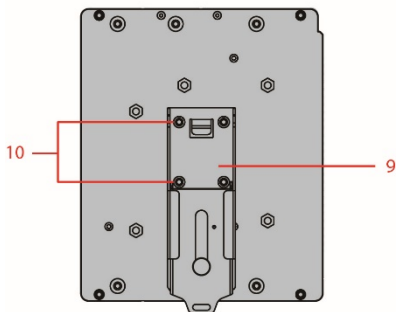

Front Panel:

1. System Status LEDs
2. Fast Ethernet Interface Module port LEDs
3. Fast Ethernet Interface Module
4. Terminal block for 2 power inputs, 1 DI/DO, and 1 relay output
5. Grounding screw
6. DIP switches for Ring Master, Ring Coupler, and Turbo Ring
7. RS-232 Console port
8. Screw to attach Fast Ethernet Interface Module

Rear Panel:

9. DIN-rail Attachment Plate
10. Screw holes for wall mounting kit

Panel Views of the EDS-611

Front View

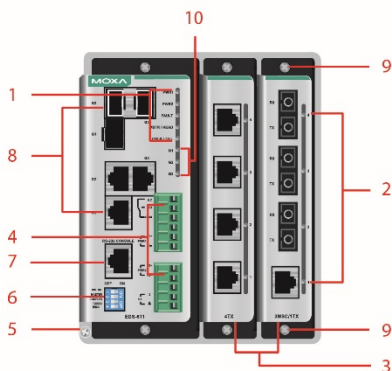

Rear View

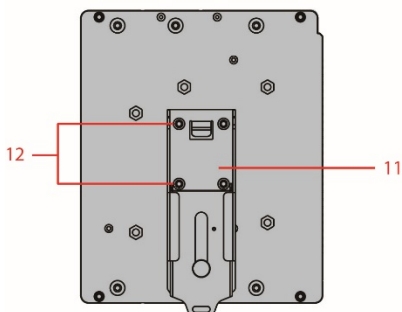

Front Panel:

1. System Status LEDs
2. Fast Ethernet Interface Module port LEDs
3. Fast Ethernet Interface Module
4. Terminal block for 2 power inputs, 1 DI/DO, and 1 Relay output
5. Grounding screw
6. DIP switches for Ring Master, Ring Coupler, and Turbo Ring
7. RS-232 Console port
8. G1 to G3: 10/100/1000 BaseT(X) or 100/1000Base SFP slot combo ports
9. Screw to attach Fast Ethernet Interface Module
10. Gigabit Ethernet LEDs

Rear Panel:

11. DIN-rail Attachment Plate
12. Screw holes for wall mounting kit

Panel Views of the EDS-616

Front View

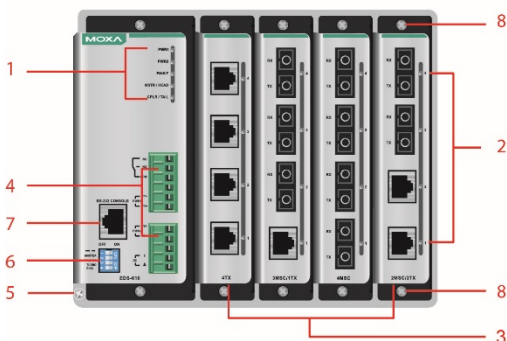

Rear View

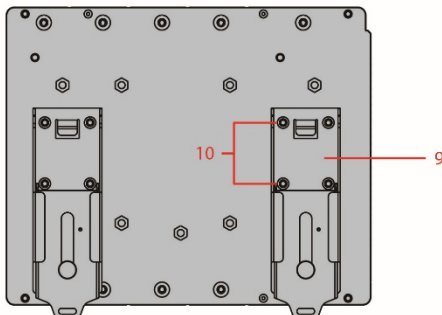

Front Panel:

1. System Status LEDs
2. Fast Ethernet Interface Module port LEDs
3. Fast Ethernet Interface Module
4. Terminal block for 2 power inputs, 1 DI/DO, and 1 relay output
5. Grounding screw
6. DIP switches for Ring Master, Ring Coupler, and Turbo Ring
7. RS-232 Console port
8. Screw to attach Fast Ethernet Interface Module

Rear Panel:

9. DIN-rail Attachment Plate
10. Screw holes for wall mounting kit

Panel Views of the EDS-619

Front View

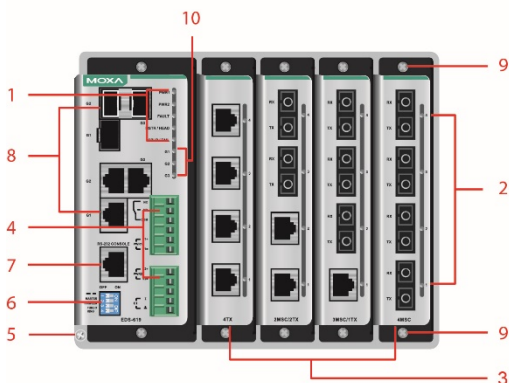

Rear View

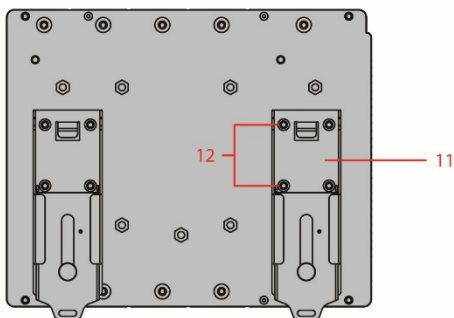

Front Panel:

1. System Status LEDs
2. Fast Ethernet Interface Module port LEDs
3. Fast Ethernet Interface Module
4. Terminal block for 2 power inputs, 1 DI/DO, and 1 relay output
5. Grounding screw
6. DIP switches for Ring Master, Ring Coupler, and Turbo Ring
7. RS-232 Console port
8. G1 to G3: 10/100/1000 BaseT(X) or 100/1000Base SFP slot combo ports
9. Screw to attach Fast Ethernet Interface Module
10. Gigabit Ethernet LEDs

Rear Panel:

11. DIN-rail Attachment Plate
12. Screw holes for wall mounting kit

Mounting Dimensions

EDS-608/EDS-611

Unit: mm (inch)

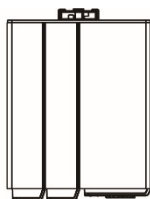

Top View

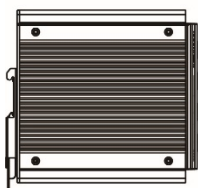

Side View

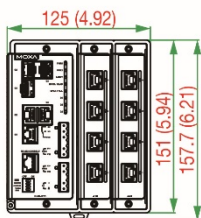

Front View

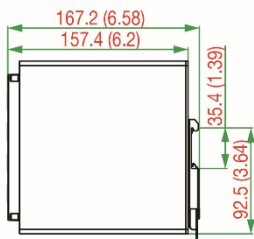

Side View

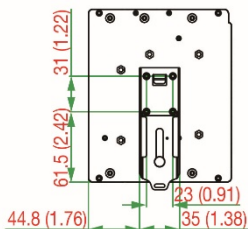

Rear View

EDS-616/EDS-619

Unit: mm (inch)

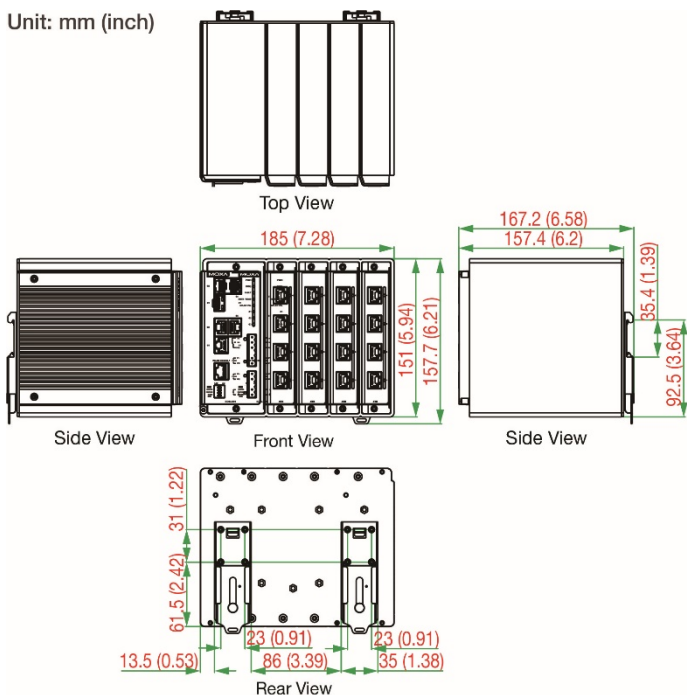

DIN-rail Mounting

The aluminum DIN-rail attachment plate should already be fixed to the back panel of the EDS-600 when you take it out of the box. If you need to reattach the DIN-rail attachment plate to the EDS-600, be sure the spring-loaded bracket is situated towards the bottom, as shown in the following figures.

STEP 1:

If the spring-loaded bracket is locked in place, push the recessed button to release it. Once released, you should feel some resistance from the spring as you slide the bracket up and down a few millimeters in each direction.

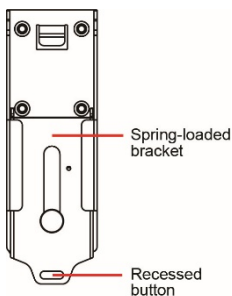

STEP 2:

Insert the top of the DIN rail into the top slots on the DIN-rail attachment plate.

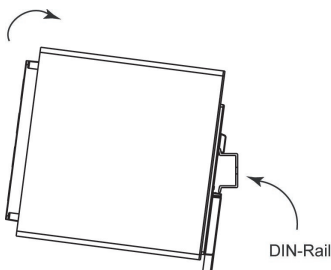
**STEP 3:**

The DIN-rail attachment unit will snap into place as shown in the following illustration.

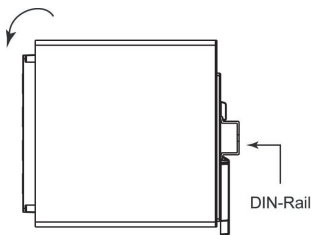

To remove the Moxa EDS-600 switch from the DIN rail, use a screwdriver to push down the spring-loaded bracket until it locks in place, as shown in the following diagram. Next, rotate the bottom of the switch upwards and then remove the switch from the DIN rail.

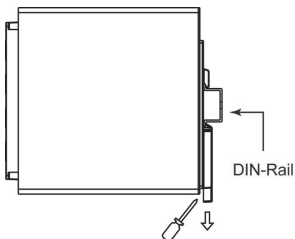
**Wall Mounting (Optional)**

For some applications, you will find it convenient to mount the EDS-600 on the wall, as shown in the following illustrations:

STEP 1: Remove the aluminum DIN-rail attachment plate from the rear panel of the EDS-600, and then attach the wall mount plates with M3 screws, as shown in the figure at the right.

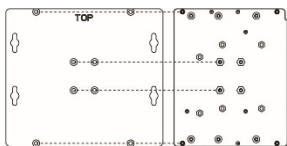
EDS-608/EDS-611

Wall Mount Kit

Rear View

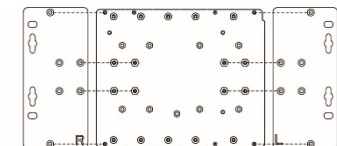
EDS-616/EDS-619

Wall Mount Kit

Rear View

Wall Mount Kit

STEP 2: Mounting the EDS-600 on the wall requires 4 screws. Use the EDS-600, with wall mount plates attached, as a guide to mark the correct locations of the 4 screws. The heads of the screws should be less than 6.0 mm in diameter, and the shafts should be less than 3.5 mm in diameter, as shown in the figure at the right.

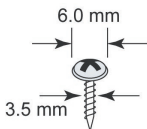

NOTE Before tightening the screws into the wall, make sure the screw head and shank size are suitable by inserting the screw through one of the keyhole-shaped apertures of the Wall Mounting Plates.

Do not screw the screws in all the way—leave about 2 mm to allow room for sliding the wall mount panel between the wall and the screws.

STEP 3: Once the screws are fixed to the wall, insert the four screw heads through the wide parts of the keyhole-shaped apertures, and then slide the EDS-600 downwards, as indicated in the figure at the right. Tighten the four screws for more stability.

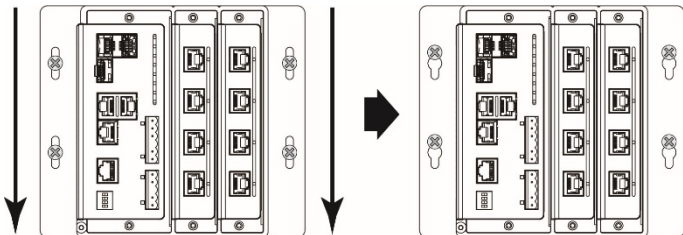

ATEX Information



1. Certificate number: DEMKO 11 ATEX 1007817X
2. Certification string: Ex nA nC IIC T4 Gc
3. Standards covered: EN 60079-0:2012+A11:2013, EN 60079-15:2010
4. Special Conditions of Use:
 - Devices are to be installed in an ATEX certified Zone 2 enclosure rated IP54 in accordance with EN 60529 that is accessible only with the use of a tool.
 - Devices are for use in an area of not more than pollution degree 2 in accordance with EN 60664-1.
 - Provisions shall be made, external to the apparatus, to prevent the rated voltage being exceeded by the transient disturbances of more than 140%.
 - Accessory Modules CM-600-4TX, CM-600-4MSC, CM-600-4SSC, CM-600-4MST, CM-600-2MSC/2TX, CM-600-2SSC/2TX, CM-600-3MSC/1TX, CM-600-3SSC/1TX must be used with Models EDS-608, EDS-608-T, EDS-611, EDS-611-T, EDS-616, EDS-616-T, EDS-619, and EDS-619-T.
 - When customers use their own optical SFP communication modules, these must be limited to Laser Class 1 only in accordance with EN 60825-1.

Wiring Requirements



WARNING

Do not disconnect modules or wires unless power has been switched off or the area is known to be non-hazardous. The devices may only be connected to the supply voltage shown on the type plate. The devices are designed for operation with a Safety Extra-Low Voltage. Thus, they may only be connected to the supply voltage connections and to the signal contact with the Safety Extra-Low Voltages (SELV) in compliance with IEC950/ EN60950-1/ VDE0805.



ATTENTION

These devices are open-type devices that need to be installed in an enclosure only accessible with the use of a tool that is suitable for the environment.



ATTENTION

Safety First!

Be sure to disconnect the power cord before installing and/or wiring your Moxa EtherDevice Switch.

Calculate the maximum possible current in each power wire and common wire. Observe all electrical codes dictating the maximum current allowable for each wire size.

If the current goes above the maximum ratings, the wiring could overheat, causing serious damage to your equipment.

Please read and follow these guidelines:

- Use separate paths to route wiring for power and devices. If power wiring and device wiring paths must cross, make sure the wires are perpendicular at the intersection point.
NOTE: Do not run signal or communications wiring and power wiring through the same wire conduit. To avoid interference, wires with different signal characteristics should be routed separately.
- You can use the type of signal transmitted through a wire to determine which wires should be kept separate. The rule of thumb is that wiring sharing similar electrical characteristics can be bundled together
- You should separate input wiring from output wiring
- We advise that you label the wiring to all devices in the system.

Grounding the Moxa EDS-600

EDS switches are designed to enhance EMS performance by grounding. EDS switches come with metal DIN-rail brackets for grounding the switches. For optimal EMS performance, connect the chassis ground nut on the switch to the grounding point.

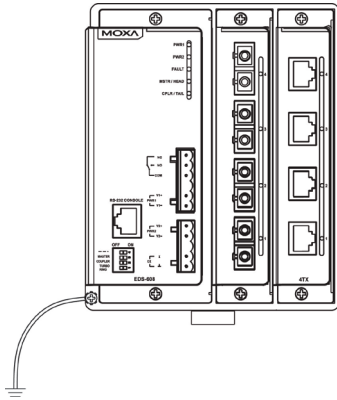

ATTENTION

This product is intended to be mounted to a well-grounded mounting surface such as a metal panel.

Wiring the Relay Contact

The EDS-600 has a set of relay outputs. The relay contact uses two of the terminal block's contacts located on the EDS-600's front panel. Refer to the next section for detailed instructions on how to connect the wires to the terminal block connector, and how to attach the terminal block connector to the terminal block receptor.

In this section, we illustrate the meaning of the two contacts used to connect the relay contact.

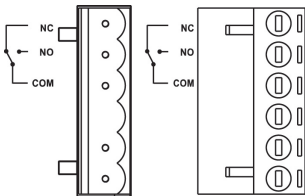

FAULT:

The relay contacts of the 6-pin terminal block connector are used to detect user-configured events. The three wires attached to the fault contacts form an open circuit when a user-configured event is triggered. If a user-configured event does not occur, the fault circuit remains closed. The relay output has current carrying capacity of 1 A @ 24 VDC.

Relay Circuit Status when Power is On/Off

Power On	COM & NC	Open Circuit
	COM & NO	Short Circuit
Power Off	COM & NC	Short Circuit
	COM & NO	Open Circuit

Wiring the Redundant Power Inputs

The EDS-600 has two sets of power inputs, power 1 and power 2, which are located on the EDS-600's front panel. Power 1 is the bottom

two contacts on the upper 6-contact terminal block and power 2 is the top two contacts on the lower 5-contact terminal block.

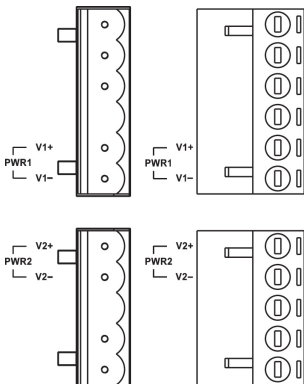

STEP 1: Insert the negative/positive DC wires into the V-/V+ terminals, respectively.

STEP 2: To keep the DC wires from pulling loose, use a small flat-blade screwdriver to tighten the wire-clamp screws on the front of the terminal block connector.

STEP 3: Insert the plastic terminal block connector prongs into the terminal block receptor, which is located on the EDS-600's front panel.



ATTENTION

We suggest using a copper conductor with the cable type – AWG (American Wire Gauge) 22 and the corresponding pin type cable terminals. In addition, the wire must be able to withstand at least 105°C.

Wiring the Digital Inputs

The EDS-600 has one set of digital inputs (DIs). Each DI consists of two contacts of the 5-pin terminal block connector on the EDS-600's front panel, which are used for the one DC input. The top and front views of one of the terminal block connectors are shown here.

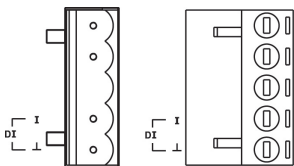

STEP 1: Insert the negative (ground)/positive DI wires into the \perp /I1 terminals, respectively.

STEP 2: To keep the DI wires from pulling loose, use a small flat-blade screwdriver to tighten the wire-clamp screws on the front of the terminal block connector.

STEP 3: Insert the plastic terminal block connector prongs into the terminal block receptor, which is located on the EDS-600's front panel.

- +13 to +30 V for state "1"
- -30 to +3 V for state "0"
- Max. input current: 8 mA

Communication Connections

EDS-600 Series switches have different types of communication ports:

- 1 RJ45 console port (RS-232 interface).
- Up to 3 Gigabit combo 10/100/1000T(X) or 100/1000BaseSFP ports.
- 4-port Fast Ethernet interface modules that include 10/100BaseT(X) and 100BaseFX ports with SC/ST connectors.

RS-232 Connection

The EDS-600 has one RS-232 (10-pin RJ45) console port, located on the front panel. Use either an RJ45-to-DB9 (see the following cable wiring diagrams) to connect the EDS-600's console port to your PC's COM port. You may then use a console terminal program, such as Moxa PComm Terminal Emulator, to access the EDS-600's console configuration utility.

RJ45 (10-pin) Console Port Pinouts

Pin	Description
1	-
2	DSR
3	RTS
4	-
5	TxD
6	RxD
7	GND
8	CTS
9	DTR
10	-

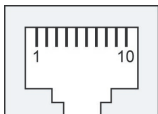

RJ45 (10-pin) to DB9 (F) Cable Wiring

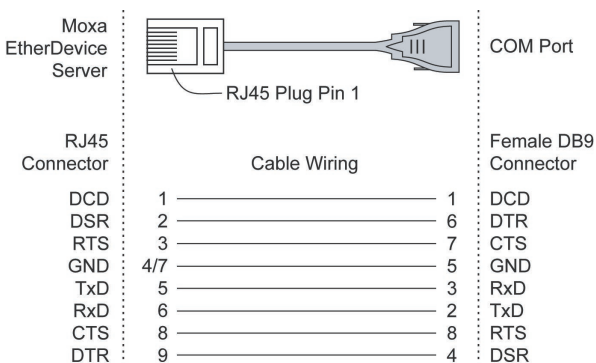

10/100/1000BaseT(X) Ethernet Port Connection

The 10/100/1000BaseT(X) ports located on switch's front panel are used to connect to Ethernet-enabled devices. Most users will choose to configure these ports for Auto MDI/MDI-X mode, in which case the port's pinouts are adjusted automatically depending on the type of Ethernet cable used (straight-through or cross-over), and the type of device (NIC-type or HUB/Switch-type) connected to the port.

The following charts display the pinouts for both MDI (NIC-type) ports and MDI-X (HUB/Switch-type) ports. We also present cable wiring diagrams for straight-through and cross-over Ethernet cables.

10/100Base T(x) RJ45 Pinouts

MDI Port Pinouts

Pin	Signal
1	Tx+
2	Tx-
3	Rx+
6	Rx-

MDI-X Port Pinouts

Pin	Signal
1	Rx+
2	Rx-
3	Tx+
6	Tx-

8-pin RJ45

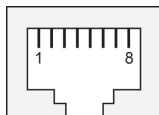

1000BaseT RJ45 Pinouts

Pin	MDI	MDI-X
1	BI_DA+	BI_DB+
2	BI_DA-	BI_DB-
3	BI_DB+	BI_DA+
4	BI_DC+	BI_DD+
5	BI_DC-	BI_DD-
6	BI_DB-	BI_DA-
7	BI_DD+	BI_DC+
8	BI_DD-	BI_DC-

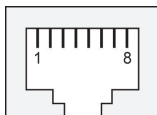

RJ45 (8-pin) to RJ45 (8-pin) Straight-Through Cable Wiring

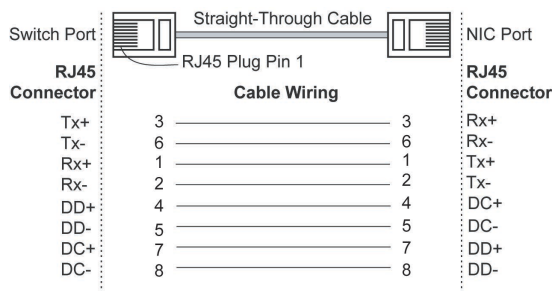

RJ45 (8-pin) to RJ45 (8-pin) Cross-Over Cable Wiring

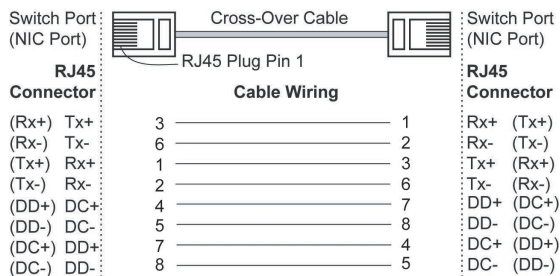

100BaseFX or 1000BaseSFP Fiber Port

The Gigabit Ethernet ports on the EDS-600 series are SFP slots, which require 100BaseFX SFP or Gigabit mini-GBIC fiber transceivers to work properly. Moxa provides complete transceiver models for various distance requirements.

The concept behind the LC port and cable is quite straightforward. Suppose you are connecting devices 1 and 2. Unlike electrical signals, optical signals do not require a circuit in order to transmit data. Consequently, one of the optical lines is used to transmit data from device 1 to device 2, and the other optical line is used to transmit data from device 2 to device 1, for full-duplex transmission.

Remember to connect the Tx (transmit) port of device 1 to the Rx (receive) port of device 2, and the Rx (receive) port of device 1 to the Tx (transmit) port of device 2. If you make your own cable, we suggest labeling the two sides of the same line with the same letter (A-to-A and B-to-B, as shown below, or A1-to-A2 and B1-to-B2).

LC-Port Pinouts

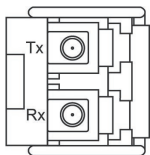

LC-Port to LC-Port Cable Wiring

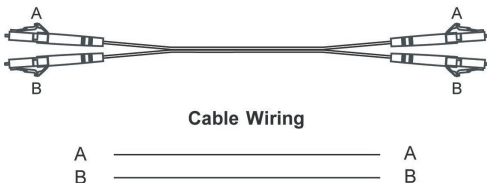

ATTENTION

This is a Class 1 Laser/LED product. To avoid causing serious damage to your eyes, do not stare directly into the laser beam.

Turbo Ring DIP Switch Settings

EDS-600 series switches are managed redundant plug-and-play Ethernet switches. The proprietary Turbo Ring protocol was developed by Moxa to provide better network reliability and faster recovery time. Moxa Turbo Ring's recovery time is less than 300 ms (**Turbo Ring**) or 20 ms (**Turbo Ring V2**)—compared to a 3- to 5-minute recovery time for commercial switches—decreasing the possible loss caused by network failures in an industrial setting.

Four DIP switches are located on the top panel of the EDS-600 to allow users to set up Turbo Ring easily within seconds. If you do not want to use a hardware DIP switch to set up Turbo Ring, you can use a web browser, Telnet, or console to disable this function.

NOTE Refer to the **Turbo Ring DIP Switch** section and **Using Communication Redundancy** section in the User's Manual for detailed information about the settings and usage of **Turbo Ring** and **Turbo Ring V2**.

EDS-600 Series DIP Switches

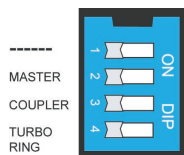

The default setting for each DIP Switch is OFF. The following table explains the effect of setting the DIP Switch to the ON position.

“Turbo Ring” DIP Switch Settings

DIP 1	DIP 2	DIP 3	DIP 4
Reserved for future use.	<u>ON</u> : Enables this EDS as the Ring Master.	<u>ON</u> : Enables the default “Ring Coupling” ports.	<u>ON</u> : Activates DIP switches 1, 2, 3 to configure “Turbo Ring” settings.
	<u>OFF</u> : This EDS will not be the Ring Master.	<u>OFF</u> : Do not use this EDS as the ring coupler.	<u>OFF</u> : DIP switches 1, 2, 3 will be disabled.

“Turbo Ring V2” DIP Switch Settings

DIP 1	DIP 2	DIP 3	DIP 4
<u>ON</u> : Enables the default “Ring Coupling (backup)” port.	<u>ON</u> : Enables this EDS as the Ring Master.	<u>ON</u> : Enables the default “Ring Coupling” port.	<u>ON</u> : Activates DIP switches 1, 2, 3 to configure “Turbo Ring V2” settings.
<u>OFF</u> : Enables the default “Ring Coupling (primary)” port.	<u>OFF</u> : This EDS will not be the Ring Master.	<u>OFF</u> : Do not use this EDS as a ring coupler.	<u>OFF</u> : DIP switches 1, 2, 3 will be disabled.

NOTE You must enable the Turbo Ring function first before using the DIP switch to activate the Master and Coupler functions.

NOTE If you do not enable any of the EDS-600 switches to be the Ring Master, the Turbo Ring protocol will automatically choose the EDS-600 with the smallest MAC address range to be the Ring Master. If you accidentally enable more than one EDS-600 to be the Ring Master, these EDS-600 switches will auto-negotiate to determine which one will be the Ring Master.

LED Indicators

The front panel of the EDS-600 contains several LED indicators. The function of each LED is described in the following table:

LED	Color	State	Description
Main System			
PWR1	AMBER	On	Power is being supplied to power input PWR1.
		Off	Power is not being supplied to power input PWR1.
PWR2	AMBER	On	Power is being supplied to power input PWR2.
		Off	Power is not being supplied to power input PWR2.
FAULT	RED	On	When the corresponding PORT alarm is enabled, and a user-configured event is triggered.
		Off	When the corresponding PORT alarm is enabled and a user-configured

LED	Color	State	Description
			event is not triggered, or when the corresponding PORT alarm is disabled.
MSTR/ HEAD	GREEN	On	When the EDS-600 is set as the Master of the Turbo Ring or is set as the Head of the Turbo Chain.
		Blinking	When the EDS-600 is set as the Ring Master of the Turbo Ring or as the Head of the Turbo Chain and the Turbo Ring or Turbo Chain is down.
CPLR/ TAIL	GREEN	On	When the EDS-600 coupling function is enabled to form a back-up path or if it is set as the Tail of the Turbo Chain.
		Blinking	When the Turbo Chain is down.
		Off	To disable the EDS-600's coupling function.
G1/G2/G3 (EDS-611/ EDS-619 only)	AMBER	On	10/100 Mbps link is active.
		Blinking	Data is being transmitted at 10/100 Mbps.
		Off	10/100 Mbps link is inactive.
	GREEN	On	1000 Mbps link is active.
		Blinking	Data is being transmitted at 1000 Mbps.
		Off	1000 Mbps link is inactive.
Interface Module			
10/100M	AMBER	On	10 Mbps link is active.
		Blinking	Data is being transmitted at 10 Mbps.
		Off	10 Mbps link is inactive.
	Green	On	100 Mbps link is active.
		Blinking	Data is being transmitted at 100 Mbps.
		Off	100 Mbps link is inactive.

Specifications

Technology	
Standards	IEEE802.3, 802.3u, 802.3x, 802.1D, 802.1w, 802.1Q, 802.1p, 802.1X, 802.3ad, 802.3z
Protocols	IGMP V1/V2 device, GMRP, GVRP, SNMP V1/V2c/V3, DHCP Server/Client, BootP, TFTP, DHCP Option66.67.82, SSH, MODBUS/TCP, SNMP INFORM, SNTP, SMTP, RARP, RMON MSTR/HEAD, CPLR/TAIL, 10/100/1000M (GB port), 10/100M (Module TX/FX port), IEEE 1588 PTP, and IPv6
MIB	MIB-II, Ethernet-like MIB, P-BRIDGE MIB, Q-BRIDGE MIB, Bridge MIB, RSTP MIB, RMON MIB Group 1,2,3,9
Interface	
RJ45 Ports	10/100/1000BaseT(X) auto negotiation speed, F/H duplex mode, and auto MDI/MDI-X connection
Fiber Ports	Optional 100/1000Base SFP modules

Console Port	RS-232 (10-pin RJ45)
System LED Indicators	PWR1, PWR2, FAULT, MSTR/HEAD, CPLR/TAIL, G1, G2, G3
Module LED Indicators	10/100M for TP port, 100M for Fiber port
Alarm Contact	Two relay outputs with current carrying capacity of 1 A @ 24 VDC
Digital Input	Two inputs with the same ground, but electrically isolated from the electronics <ul style="list-style-type: none"> • For state "1": +13 to +30 V • For state "0": -30 to +3 V • Max. input current: 8 mA
Power	
Input Voltage	12/24/48 VDC, redundant inputs Note: 24 VDC has been certified by DNV.
Input Current (@12 V)	EDS-608: 2.3 A EDS-611: 2.3 A EDS-616: 2.3 A EDS-619: 2.3 A
Connection	Two removable 5-pin and 6-pin terminal blocks
Overload Current Protection	Present
Reverse Polarity Protection	Present
Mechanical	
Casing	IP30 protection, metal case
Dimensions (W × H × D)	EDS-608/611: 125 x 151 x 157.4 mm (4.92 x 5.95 x 6.20 in) EDS-616/619: 185 x 151 x 157.4 mm (7.28 x 5.95 x 6.20 in)
Weight	EDS-608: 1.95 kg EDS-611: 2.02 kg EDS-616: 2.45 kg EDS-619: 2.51 kg
Installation	DIN rail, wall mounting kit (optional kit), anti-vibration wiring kit (optional) Note: DIN-rail mounting has been certified by DNV.
Environment	
Operating Temperature	0 to 60°C (32 to 140°F), standard models -40 to 75°C (-40 to 167°F) for -T models
Storage Temperature	-40 to 85°C (-40 to 185°F)
Ambient Relative Humidity	5 to 95% (non-condensing)
Regulatory Approvals	
Safety	UL 508, EN62368-1
Hazardous Location	UL/cUL Class I, Division 2, Groups A, B, C, and D; ATEX Zone 2, Ex nC nL IIC T4
EMI	FCC Part 15B Class A, CISPR 32 Class A, EN 55032 Class A, EN 61000-6-4
EMS	EN 61000-6-2 EN 61000-4-2 (ESD),

	<ul style="list-style-type: none"> • level 2 for multi-mode models with ST connectors • level 3 for all other models EN 61000-4-3 (RS), Level 3 EN 61000-4-4 (EFT), Level 4 EN 61000-4-5 (Surge), Level 3 EN 61000-4-6 (CS), Level 3 EN 61000-4-8
Maritime	DNV, ABS, LR, NK
Rail Traffic	EN 50121-4
Shock	IEC60068-2-27
Free Fall	IEC60068-2-32
Vibration	IEC60068-2-6
Traffic Control	NEMA TS2
WARRANTY	5 years