

UC-8100A-ME-T

Quick Installation Guide

Edition 2.0, November 2019

Technical Support Contact Information **www.moxa.com/support**

Moxa Americas:

Toll-free: 1-888-669-2872

Tel: 1-714-528-6777

Fax: 1-714-528-6778

Moxa China (Shanghai office):

Toll-free: 800-820-5036

Tel: +86-21-5258-9955

Fax: +86-21-5258-5505

Moxa Europe:

Tel: +49-89-3 70 03 99-0

Fax: +49-89-3 70 03 99-99

Moxa Asia-Pacific:

Tel: +886-2-8919-1230

Fax: +886-2-8919-1231

Moxa India:

Tel: +91-80-4172-9088

Fax: +91-80-4132-1045



© 2019 Moxa Inc. All rights reserved.

P/N: 1802081121011



Overview

The UC-8100A-ME-T computing platform is designed for embedded data acquisition applications. The UC-8100A-ME-T computer comes with two RS-232/422/485 serial ports and dual 10/100 Mbps Ethernet LAN ports, as well as a Mini PCIe socket to support cellular modules. These versatile communication capabilities let users efficiently adapt the UC-8100A-ME-T to a variety of complex communications solutions.

Package Checklist

Before installing the UC-8100A-ME-T, verify that the package contains the following items:

- UC-8100A-ME-T embedded computer
- Power jack
- Console cable
- Quick installation guide (printed)
- Warranty card



IMPORTANT!

Notify your sales representative if any of the above items are missing or damaged.

UC-8100A-ME-T Panel Layout

The following figures show the panel layouts of the UC-8100A-ME-T:

Top Panel View

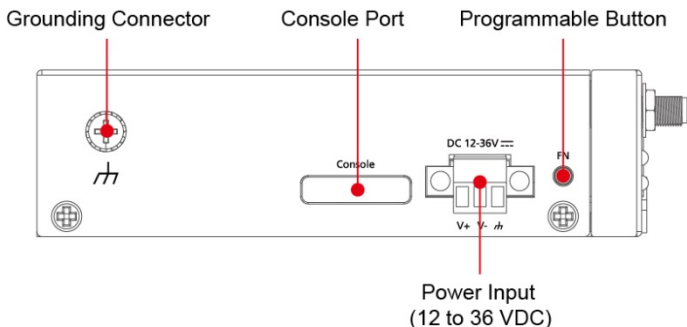



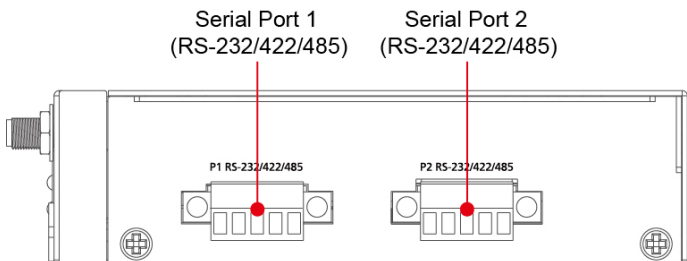

Bottom Panel View

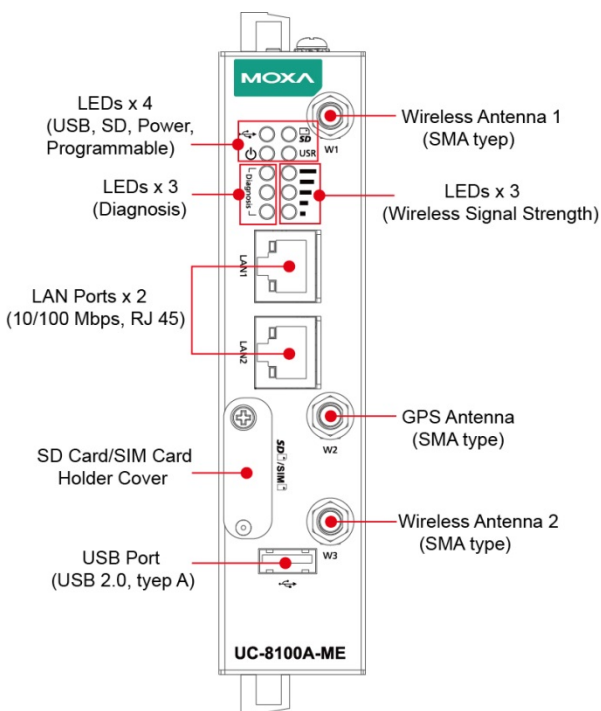

Front Panel View



LED Indicators

LED Name	Color	Function	
	USB	Green	Steady On USB device is connected and working normally.
		Off	Off USB device is not connected.
	SD	Green	Steady On SD Card inserted and working normally.
		Off	Off SD card is not detected.
	Power	Green	Green Power is on and the computer is working normally.
		Off	Off Power is off.
	LAN1/ LAN 2 (RJ45 connector)	Green	Steady On 100 Mbps Ethernet link
			Blinking Data transmission in progress
		Yellow	Steady On 10 Mbps Ethernet link
			Blinking Data transmission in progress
		Off	Off Ethernet is not connected.
	Wireless Signal Strength	Green Yellow Red	The number of glowing LEDs indicates the signal strength. 3 (Green + Yellow + Red): Excellent 2 (Yellow + Red): Good 1 (Red): Poor
		Off	Off Wireless module is not detected.
USR	User-defined	Green	This LED can be defined by users. For details, refer to <i>Hardware User's Manual</i> .

LED Name	Color	Function
<div style="writing-mode: vertical-rl; transform: rotate(180deg); border: 1px solid black; padding: 2px;">Diagnosis</div> Programmable diagnostic LEDs	Green Yellow Red	These three LEDs are programmable. For details, refer to the "Default Programmable Button Operation" section in the <i>Hardware User's Manual</i> .

Specifications

Input Current	700 mA @ 12 VDC
Input Voltage	12 to 36 VDC (3-pin terminal block, V+, V-, SG)
Power Consumption	6 W (without cellular module and external USB device attached)
Operating Temperature	Without LTE Module preinstalled: -40 to 85°C (-40 to 185°F) With LTE Module preinstalled: -40 to 70°C (-40 to 158°F)
Storage Temperature	-40 to 85°C (-40 to 185°F)

Installing the UC-8100A-ME-T

DIN-rail Mounting

The aluminum DIN-rail attachment plate is already attached to the product's casing. To mount the UC-8100A-ME-T on to a DIN rail, make sure that the stiff metal spring is facing upwards and follow these steps.

1. Pull down the bottom slider of the DIN-rail bracket located at the back of the unit
2. Insert the top of the DIN rail into the slot just below the upper hook of the DIN-rail bracket.
3. Latch the unit firmly on to the DIN rail as shown in the illustrations below.
4. Push the slider back into place.

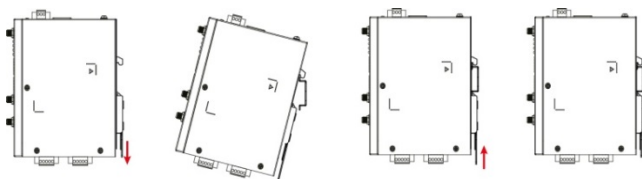
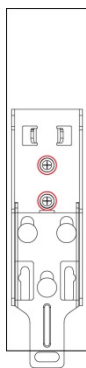

Wall Mounting (Optional)

The UC-8100A-ME-T can be mounted with a wall-mounting kit that needs to be purchased separately. Follow these steps to mount the computer on to a wall:

Step 1

Use four screws to fasten the wall-mounting brackets on the left panel of the computer.

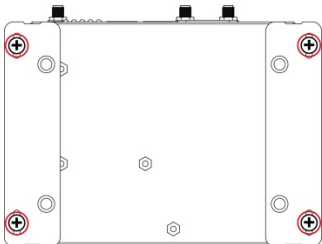

Step 2

Use another four screws to mount the computer on a wall or a cabinet.

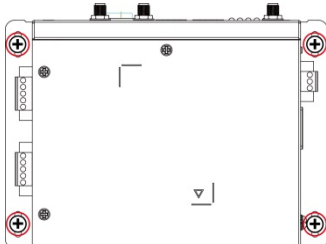

Connector Description

Power Connector

Connect the power jack (in the package) to the UC-8100A-ME-T's DC terminal block (located on the top panel), and then connect the power adapter. It takes about 30 seconds for the system to boot up. Once the system is ready, the Power LED will light up.



WARNING

EXPLOSION HAZARD!

Do not disconnect equipment unless the power has been removed or the area is known to be non-hazardous.

Grounding the UC-8100A-ME-T

Grounding and wire routing help limit the effects of noise due to electromagnetic interference (EMI).

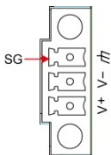

SG: The Shielded Ground (sometimes called Protected Ground) contact is the top contact of the 3-pin power terminal block connector when viewed from the angle shown here. Connect the SG wire to an appropriate grounded metal surface.

Ethernet Ports

The two 10/100 Mbps Ethernet ports (LAN 1 and LAN 2) use RJ45 connectors.

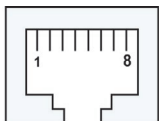

Pin	Signal
1	Tx+
2	Tx-
3	Rx+
6	Rx-

Serial Ports

The two serial ports (P1 and P2) use terminal connectors. Each port can be configured by software for RS-232, RS-422, or RS-485. The pin assignments for the ports are shown in the following table:

P1 RS-232/422/485		Pin	RS-232	RS-422	RS-485
		1	TXD	TXD+	-
		2	RXD	TXD-	-
		3	RTS	RXD+	D+
		4	CTS	RXD-	D-
		5	GND	GND	GND

SD/SIM Card Sockets

The UC-8100A-ME-T comes with an SD socket for storage expansion, and a SIM card socket for cellular communication. The SD card/SIM card sockets are located at the lower part on the front panel. To install the cards, remove the screw and the protection cover to access the sockets, and then insert the SD card or the SIM card into the sockets directly. You will hear a click when the cards are in place. To remove the cards, push the cards in before releasing them.

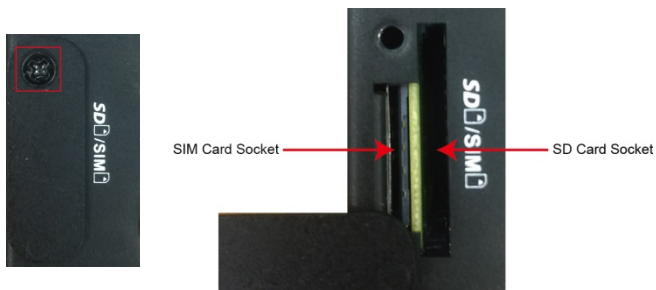

Console Port

The console port is an RS-232 port that can be connected to with a 4-pin pin header cable. You can use this port for debugging or firmware upgrade.

Pin	Signal
1	TxD
2	RxD
3	NC
4	GND



The diagram shows a 4-pin pin header with pins 1, 2, 3, and 4 labeled on the left side. Pin 1 is the top pin, followed by 2, 3, and 4 at the bottom.

USB Port

The USB 2.0 port is located at the lower part of the front panel and supports a USB storage device driver. By default, the USB storage is mounted at `/mnt/usbstorage`.

Antenna Connectors



There are three antenna connectors on the front panel of the UC-8100A-ME-T. W1 and W3 are for cellular modules, and W2 is for the GPS module. All three connectors are of SMA type.

Real-time Clock

The real-time clock in the UC-8100A-ME-T is powered by a lithium battery. We strongly recommend that you do not replace the lithium battery without the help of a Moxa support engineer. If you need to change the battery, contact the Moxa RMA service team.



ATTENTION

There is a risk of explosion if the battery is replaced with an incorrect type of battery.

Accessing the UC-8100A-ME-T Using a PC

You can use a PC to access the UC-8100A-ME-T by one of the following methods:

- A. Through the serial console port with the following settings:
Baudrate=115200 bps, **Parity**=None, **Data bits**=8, **Stop bits** =1, **Flow Control**=None



ATTENTION

Remember to choose the "VT100" terminal type. Use the console cable to connect a PC to the UC-8100A-ME-T's serial console port

- B. Using SSH over the network. Refer to the following IP addresses and login information:

	Default IP Address	Netmask
LAN 1	192.168.3.127	255.255.255.0
LAN 2	192.168.4.127	255.255.255.0

Login: moxa

Password: moxa



ATTENTION

- The equipment shall only be used in an area of not more than pollution degree 2, as defined in IEC/EN 60664-1.
- The equipment shall be installed in an enclosure that provides a degree of protection not less than IP 54 in accordance with IEC/EN 60079-15 and accessible only by the use of a tool.
- These devices are open-type devices that are to be installed in an enclosure with tool removable cover or door, suitable for the environment.
- This equipment is suitable for use in Class I, Division 2, Groups A, B, C, and D or non-hazardous locations only.
- ANTENNAS INTENDED FOR USE IN CLASS I, DIVISION 2 HAZARDOUS LOCATIONS MUST BE INSTALLED WITHIN THE END-USE ENCLOSURE. FOR REMOTE MOUNTING IN AN UNCLASSIFIED LOCATION, ROUTING AND INSTALLATION OF THE ANTENNAS SHALL BE IN ACCORDANCE WITH NATIONAL ELECTRICAL CODE REQUIREMENTS (NEC/CEC) Sec. 501.10(b).
- The "USB, RS-232/422/485 serial ports, LAN1, LAN2, and Console ports" and Reset Button may only be accessed for equipment set-up, installation, and maintenance at a non-hazardous location. These ports and their associated interconnecting cables must remain inaccessible within the hazardous location.